

# MICRO SOLUTIONS > FOR AUTOMOTIVE

*As automakers respond to increased demands for in-vehicle processing power, Molex leverages its high-speed data experience to deliver solutions for the next-generation of intelligent automobiles.*

**CONNECTED  
MOBILITY**

**COMFORT  
INFOTAINMENT**

**CAR-ELECTRONICS**

**molex**

# SOLUTIONS FOR CONNECTED MOBILITY

The development of connected mobility continues to increase the need for in-vehicle cameras and radars. In support of this trend, Easy-On FFC/FPC and SlimStack Board-to-Board Connectors offer much-needed compactness while managing data transmission growth.



## An example of a radar application

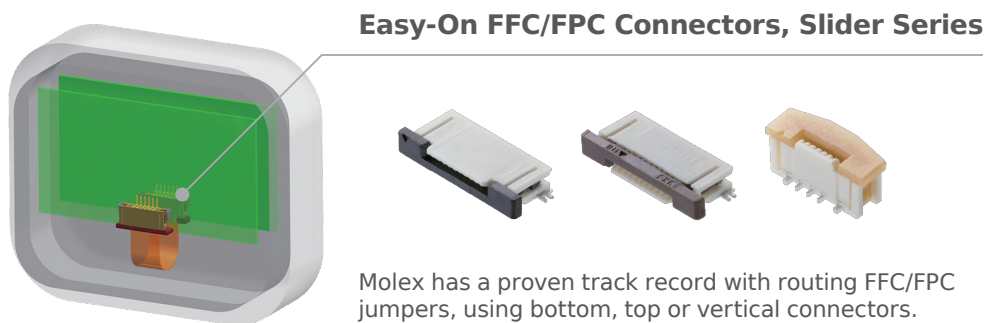

## An example of a camera application

### SlimStack Board-to-Board Connectors, J-Bend Series

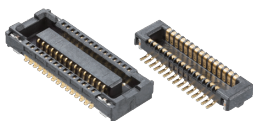

The SlimStack 0.40mm Pitch Connector Family can be used in a wide range of applications from mobile devices to industrial equipment.

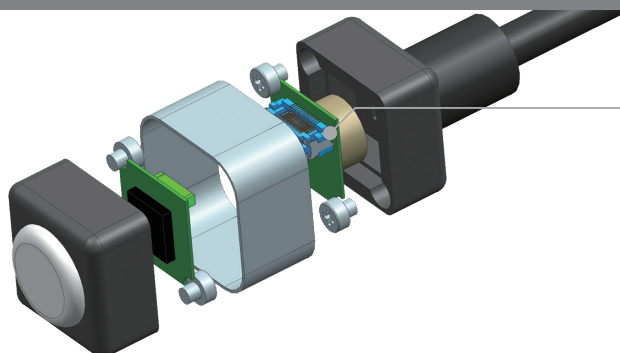

### SlimStack Board-to-Board Connectors, FSB5 Series

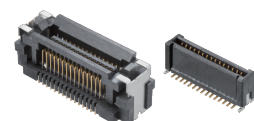

The FSB5 series of connectors are a new small footprint floating board-to-board connector.

# SOLUTIONS FOR COMFORT INFOTAINMENT

Automobile designers strive to optimize the in-vehicle experience for both drivers and passengers with multiple interior LCD panels. Molex's Easy-On FFC/FPC portfolio delivers a variety of options that deliver superior connectivity for these applications.

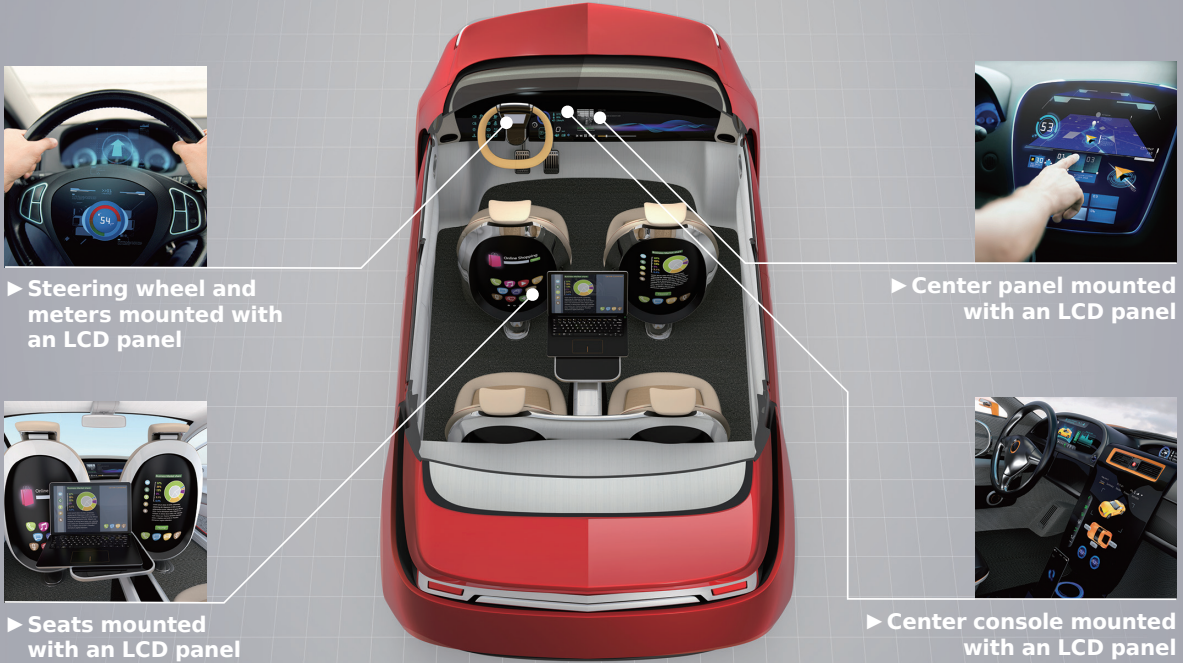

## Examples of built-in LCD interior panel applications

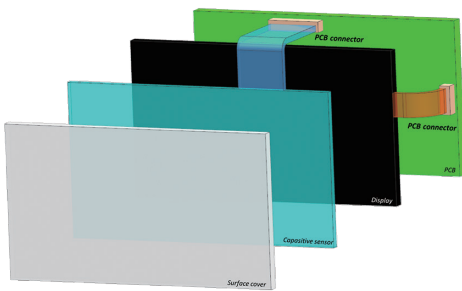

### Easy-On FFC/FPC Connectors, FD19 Series

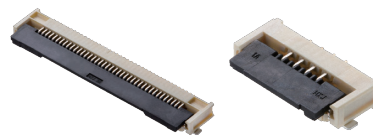

Front-flip FPC Connectors with two independent contact points are vibration resistant.

### Easy-On FFC/FPC Connectors, V-Flip Series



These are small, vertical-flip FPC Connectors that enable connection to the PCB center and multiple SMT mounting.

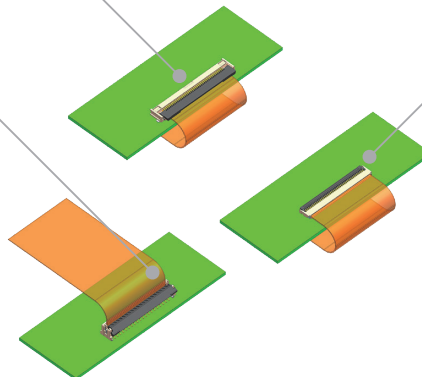

### Easy-On FFC/FPC Connectors, FBH1 Series



The thickness of modules and devices can be reduced by using Series FBH1 ultra-low profile connectors (1.00mm height).

# SOLUTIONS FOR > CAR-ELECTRONICS

As data integration throughout the entire vehicle advances, Molex offers the cutting-edge technology to meet the latest electronic connection requirements and specifications.



▶ Combination switch



▶ Sequential turn signal



▶ Wireless charging module



▶ LED headlight

## An example of a combination switch application

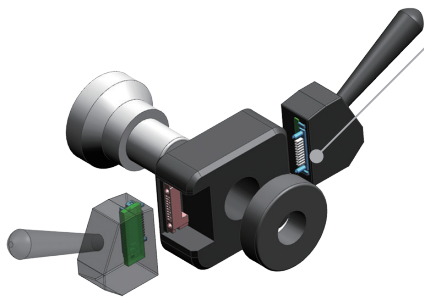

### SlimStack Board-to-Board Connectors, FSR1 Series

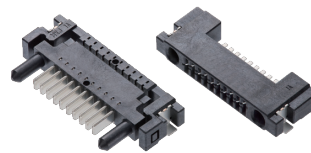

Series FSR1 can be used to simplify combination switch connections.

## An example of a wireless charger application

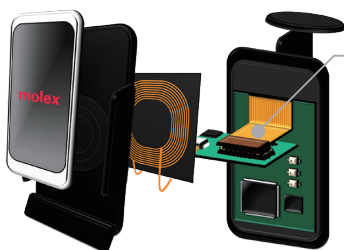

### SlimStack Board-to-Board Connectors, Battery and SSB RP Series

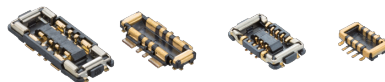

This series of connectors can be used for high current and high retention force applications.

### Easy-On FFC/FPC Connectors, Flexi-Latch Series



These are latch-type FFC/FPC-to-Board Connectors that can be used for high current applications (2.0A), used in LED headlight connections.

## Easy-On FFC/FPC Connectors



## SlimStack Board-to-Board Connectors

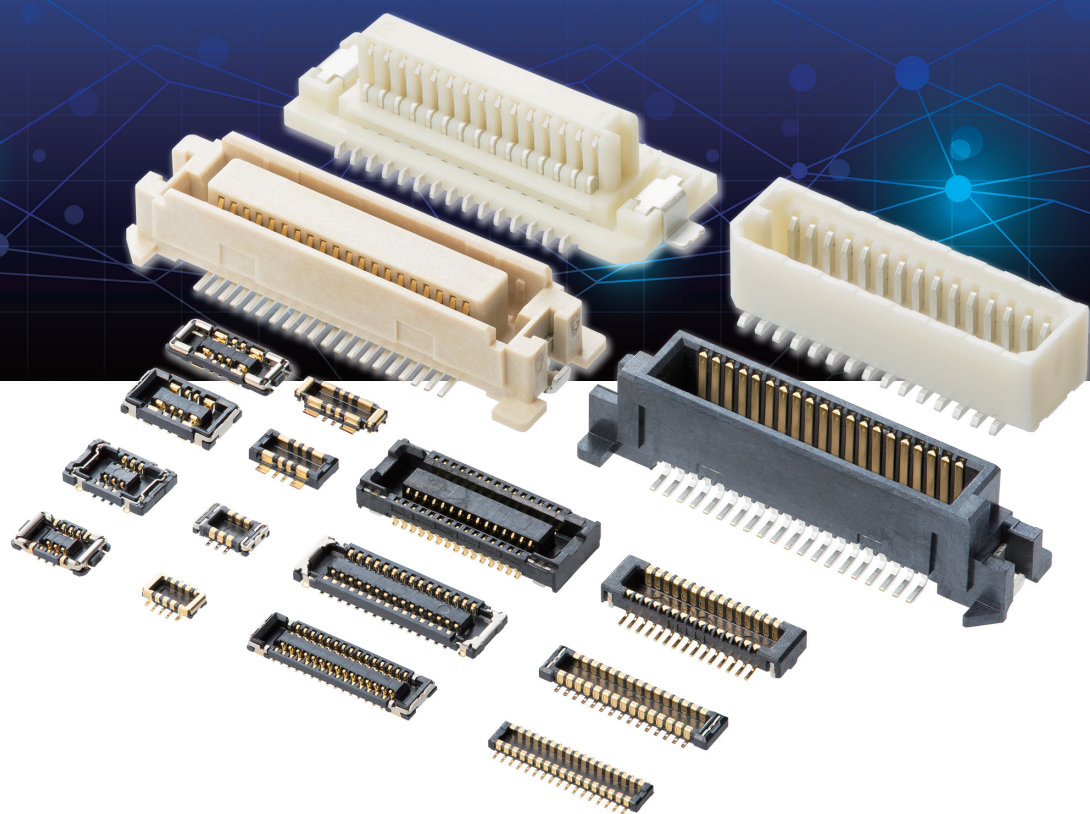

[www.molex.com/link/microconnectors.html](http://www.molex.com/link/microconnectors.html)

**molex**  
one company › a world of innovation

Molex is a registered trademark of Molex, LLC in the United States of America and may be registered in other countries; all other trademarks listed herein belong to their respective owners.

Order No. 987651-9231

Japan/0k/CH/HC/2018.09

©2018 Molex