

molex[®]

Brad[®] automation catalog

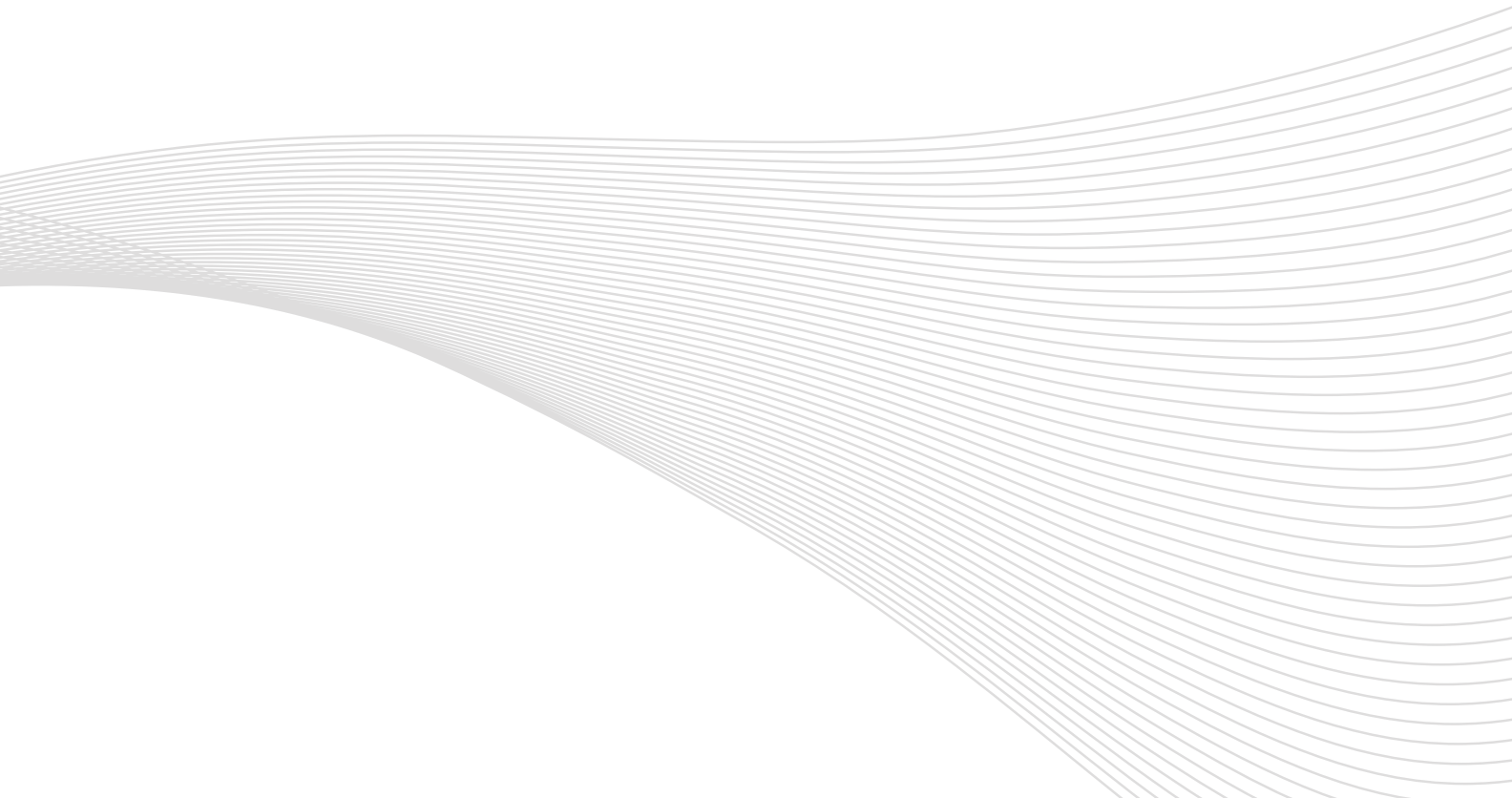

Table of Contents

Passive Media

Ultra-Lock® (US)	19
Cordsets	20 to 24
Receptacles	25 to 26
Field Attachable Connectors	27
Splitter Cordsets	28
Distribution Boxes	29 to 36
Micro-Change® (M12) (US)	37
Cordsets	38 to 48
Receptacles	49 to 50
Field Attachable Connectors	51
Solid Body Splitter and Tees	52
Splitter Cordsets	53
Distribution Boxes	54 to 61
Dual Key Cordsets	62 to 65
Dual Key Receptacles	66 to 67
Dual Key Field Attachables	68
Nano-Change® (M8) (US)	69
Cordsets	70 to 72
Receptacles	73 to 74
Field Attachable Connectors	75
Distribution Boxes	76 to 78
Snap Cordsets	79
Ultra-Lock (EUROPE)	81
Cordsets	82 to 86
Receptacles	87 to 88
Field Attachable Connectors	89
Splitter Cordsets	90
Distribution Boxes	91 to 98
Micro-Change (M12) (EUROPE)	99
Cordsets	100 to 110
Receptacles	111 to 112
Field Attachable Connectors	113
Solid Body Splitter and Tees	114
Splitter Cordsets	115
Distribution Boxes	116 to 123
Nano-Change (M8) (EUROPE)	125
Cordsets	126 to 128
Receptacles	129 to 130
Field Attachable Connectors	131
Distribution Boxes	132 to 134
Snap Cordsets	135

Mini-Change®	137
A-Size	
Cordsets	138 to 143
Receptacles	144 to 148
Bulkheads	149
Field Attachable Connectors	150
Plugs	151
Tee Connectors	152
Adaptors	153
Accessories	153
Distribution Boxes	154 to 157
B-Size	
Cordsets	158 to 160
Receptacles	161 to 162
Accessories	163
C-Size	
Cordsets	164 to 166
Receptacles	167 to 168
19-Pole Single and Double-Ended Cordsets	169
19-Pole Receptacles	170
Accessories	171
M23	173
Signal	
Connectors	174 to 175
Receptacles	176 to 179
Cordsets	180
Power	
Connectors	181 to 182
Receptacles	183 to 184
Tools and Accessories	185
mPm® DIN	187
Field Attachables	188 to 192
Molded Cables	193 to 197
Technical Features	198
Available Circuit Sizes	199

Power Products

NFPA 79-2012 Compliant	204
Trunk/Feeder	
Cordsets	205 to 207
Tees	208
Reducers	209
Receptacles	210
Field Attachable Connectors	211
Drop/Branch	
Cordsets	212 to 214
Receptacles	215
Field Attachable Connectors	216
Accessories	
Closure Caps and Locking Clips	217
Emergency Stop Cordsets and Tees	218
Emergency Stop Receptacles and Terminators	219

Network Solutions

DeviceNet*	224 to 225
Remote Scanners	226
Diagnostic Tools	227
Interface Cards	228
Interface Modules	229 to 230
Common Industrial Safety Software Kits	231
I/O Modules	232 to 233
Bulk Cables	234 to 237
Mini-Change®	
Cordsets	238 to 244
Receptacles	245 to 247
Field Attachable Connectors	248
Terminator Resistors	249
Tees and Adapters	250 to 253
Passive Multi-Ports	254 to 255
Micro-Change® (M12)	
Cordsets	256 to 261
Receptacles	262 to 263
Field Attachable Connectors	264
Terminators	265
Tees and Splitters	266
Passive Multi-Ports	267 to 268
Open Style	
Cordsets	269 to 270
Receptacle Assemblies	271
Nano-Change® (M8)	
Cordsets	272 to 276
Passive Multi-Ports	277
Auxiliary Power Media	
Mini-Change®	
Cordsets	278
Adapters	279
Field Attachable Connectors	280
Power Taps	281
Machine Stop Tees	282
Micro-Change® (M12) and Ultra-Lock®	
Cordsets	283 to 284
Receptacles	285
Field Attachable Connectors	286
PROFIBUS†	288
Adapters	290
Interface Cards	290 to 297
Communication Modules	298 to 299
Industrial Gateway	300
I/O Modules	301 to 302
Cables	303

*DeviceNet is a trademark of Open DeviceNet Vendor Association (ODVA).

†PROFIBUS is a trademark of PROFIBUS International

Micro-Change® (M12)	
Cordsets	304 to 306
Receptacles	307 to 309
Field Attachable Connectors	310
Terminators	311
Tees	312
D-Sub	
Field Attachable Connectors	313
Cordsets	314 to 318
Auxiliary Power Media	
Mini-Change®	
Cordsets	319
Receptacles	320
Field Attachable Connectors	321
Tees	322
Micro-Change® (M12) and Ultra-Lock®	
Cordsets (US)	323 to 324
Cordsets (Europe)	325 to 326
Receptacles (US)	327
Receptacles (Europe)	328
Field Attachable Connectors	329
Ethernet	330
Development Kits	332 to 333
Windows* Compatible Drivers	334 to 335
Network Interface Cards	336 to 337
Communication Modules	338
I/O Modules	339 to 340
Common Industrial Safety Software Kits	341
Ethernet Switches	342 to 343
RJ-Lnxx® RJ-45 and Standard RJ-45	
Cordsets	344 to 348
Receptacles	349 to 353
Field Attachable Connectors	354
Accessories	354
Sealed RJ-45	
Cordsets	355 to 357
Receptacles	358
Field Wireable Connectors	359
Dust Caps	359
Micro-Change® (M12)	
Cordsets	360 to 363
Field Attachable Connectors	364
Ultra-Lock®	
Cordsets	365 to 366
Receptacles	367 to 370
Micro-Change® (M12)	
Adapters	371
Circular Hybrid Technology Connector	372
X-Coded	373 to 374

*Windows is a registered trademark of Microsoft Corporation.

Other Networks	376
Communication Modules	378
Network Interface Cards	379 to 381
Windows Compatible Protocol Drivers	382
I/O Modules	383
PICS Simulation Software	384
NMEA 2000*	385
Bulk Cables	386
Micro-Change[®] (M12)	
Cordsets	387 to 389
Receptacles	390
Field Attachable Connectors	391
Terminator Resistors	392
Tees	393 to 394
Junction Boxes	395
Mini-Change[®]	
Cordsets	396
Field Attachable Connectors	397
Terminator Resistors	398
Tees	399
Power Tap	400
Auxiliary Power Media Cordsets	401
Micro-Change[®] (M12) and Mini-Change[®]	
Receptacles	402
Closure Caps	402
Industrial USB	403
Cordsets	404 to 405
Receptacles	406
Dust Cap	407
Cable Chemical Resistance Chart/Specifications and Wire Diameters	408
Stranded Wire Cross-Reference	409
Approval Codes	410 to 412
Glossary	413 to 418
Series No. Index	i
Order No. Index	ii to xiii
Engineering No. Index	xiv to xxv

*NMEA 2000 is a trademark of the National Marine Electronics Association

Product Page Overview

Features and Benefits

Specifications

Trade Name → **Brad® Micro-Change® (M12)**

Application/Product Type → **A-Code
Single-Ended Cordsets
(US)**

Series Number → **120065**

Product Description → **Male, Pigtail
Straight, Right Angle**

Photo →



- Features and Benefits**
- M12 Single Keyway (A-Coded) IEC compliant cordset assemblies
 - 3, 4, and 5-pole versions are interchangeable for added flexibility
 - IP67/68 rated for harsh environments
 - Patented anti-vibration feature to prevent loosening under high vibration applications
 - Wide selection of cables to fit applications
 - PVC cables for light, cost sensitive industrial applications
 - PUR cables for moderate flexing and for environments encountering cutting fluids and oils
 - TPE cables for continuous flex applications. Also ideal for welding cells; cable is weld slag resistant

Physical

Connector Body: PUR (TPE for K05)
 Contact Carries: Polyamide
 O-ring: Viton (EPDM for A09 cables)
 Coupling Nut: Nickel-plated Brass (Teflon coated for K05)
 Contacts: Copper alloy with Gold over Nickel plating
 Cables: A09—Yellow PVC jacket, 22 AWG PVC conductors, 300V, UL AWM2661
 K05—Yellow TPE jacket, 22 AWG PVC conductors, 300V, UL PLTC-ER, +10M flex life (torsion and bending)

Environmental

Protection: IP67
 NEMA Rating: NEMA 6

Reference Information

UL File No.: E152210 (A09 and K05 cable assemblies)
 CSA File No.: LR6837 (A09 and K05 cable assemblies)

Reference Information

Ordering Information →

Poles	Max. Current per Contact	Max. Voltage	Cable Type	Cable Jacket (Cable Code)	Wire Size AWG	Length	Male Straight		Male Right Angle	
							Engineering No.	Standard Order No.	Engineering No.	Standard Order No.
3 Pole 1 - Brown 4 - Black 3 - Blue	4.0A	250V AC/DC	UL 2661	PVC (A09)	22	2.0m	803006A09M020	120065-0200	803007A09M020	120065-1497
			PLTC-ER	TPE (K05)			803006K05M020	120065-1114	803007K05M020	120065-1501
4 Pole 1 - Brown 3 - Blue 2 - White 4 - Black	4.0A	250V AC/DC	UL 2661	PVC (A09)	22	2.0m	804006A09M020	120065-0414	804007A09M020	120065-1662
			PLTC-ER	TPE (K05)			804006K05M020	120065-1129	804007K05M020	120065-1691
5 Pole 1 - Brown 4 - Black 2 - White 5 - Gray 3 - Blue	4.0A	250V AC/DC	UL 2661	PVC (A09)	22	2.0m	805006A09M020	120065-0523	805007A09M020	120065-1724

Important Notes →

Note: Sales drawings for all standard order numbers are available on molex.com

Configuration Code Build-a-Part-Number (allows for creation of unique engineering numbers if an order number doesn't already exist)

Configuration Code*
Build-a-Part Number

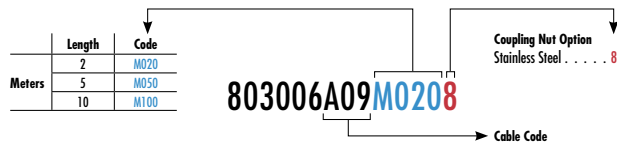

*Once an engineering number is created using the configuration code, consult Molex tech support for information regarding any part numbers.

Link to website → www.molex.com



Find the Latest Innovations and Information at Molex.com

For the most in-depth and up-to-date information on all our products, visit Molex.com. It's designed to help you get more done in less time with advanced search capabilities, 3D models, product specifications, easy sample ordering and more.



Molex.com provides a first stop for comprehensive overviews of our industrial products. Some of the tools you'll find are:

Capabilities Videos

Short online videos highlight key industry products, as well as our unique cross-functional design and manufacturing capabilities.

Featured Products

To find out about new products that can take your design to the next level, look no further than this convenient product spotlight.

Other Time-Saving Site Features

Monthly E-ouncements

Electronic newsletter keeps you up-to-date on our latest innovations

Favorite Products Feature

Lets you select and save up to 200 products as you browse

Electrical Testing Models and Data

Available on an array of products in our "Signal Integrity" section

New Videos, Webinars, Articles and More

Available right from our home page

Detailed Application Pages

Instant Access to Product Specs

total system solution



Molex is a leading one-source supplier of interconnect products. Our team of highly skilled experts is focused on the design, development and distribution of innovative product solutions that touch virtually every walk of life. The Molex product portfolio is among the world's most extensive, with over 100,000 reliable products. Because our product line includes automation products for passive media, network media and power applications, Molex can interconnect an entire automation infrastructure—one total system solution from a global company dedicated to meeting your total system needs. Molex utilizes extensive worldwide resources to meet customer needs on a local, regional and global level. Molex offers well-established sales, product development, manufacturing and logistics resources in Asia, Europe and the Americas.

design



If you're designing or engineering an automation infrastructure, Molex will provide a system that includes passive media, network solutions and power products bearing the Brad® name.

install



If you're installing an automation infrastructure, you'll appreciate how simply and precisely the Brad components go together—and stay together—thanks to quick-connect convenience, including our exclusive Ultra-Lock® Connection System.

maintain



If system maintenance is your responsibility, Brad products are built to help—and endure. Features like epoxy-coated couplings, palladium/nickel plating, female contacts that maintain constant pressure on the male contacts, moisture-resistant design and seal construction, ultra-tough cable materials, anti-vibration technology, quick-connects, and many others help maintain system performance, minimize downtime, maximize product life, even simplify maintenance.

Brad® Components are Everywhere

With Brad components, you only need one convenient source to spec all of your industrial connectors and applications. Standardize with Brad products and watch your design, installation, and maintenance processes become vastly simplified—a total system solution.

SERVING THESE AND OTHER MARKETS

Industrial Device
Manufacturing

Automotive

Robotics

Food/Beverage

Material Handling

Alternative Energy
(e.g. solar, wind)

Commercial Vehicle



connectivity

Connectors, cordsets and distribution boxes for sensor, actuator and bus network applications



power

Modular, flexible wiring systems for machine power distribution and motor control



control

Network I/O for on-machine and in-cabinet applications



communications

Network interface cards, PLC backplanes, switches, gateways, simulation software and diagnostic tools

Passive Media

Ultra-Lock® (US)	19	Mini-Change®	137
Cordsets	20 to 24	A-Size	
Receptacles	25 to 26	Cordsets	138 to 143
Field Attachable Connectors	27	Receptacles	144 to 148
Splitter Cordsets	28	Bulkheads	149
Distribution Boxes	29 to 36	Field Attachable Connectors	150
Micro-Change® (M12) (US)	37	Plugs	151
Cordsets	38 to 48	Tee Connectors	152
Receptacles	49 to 50	Adaptors	153
Field Attachable Connectors	51	Accessories	153
Solid Body Splitter and Tees	52	Distribution Boxes	154 to 157
Splitter Cordsets	53	B-Size	
Distribution Boxes	54 to 61	Cordsets	158 to 160
Dual Key Cordsets	62 to 65	Receptacles	161 to 162
Dual Key Receptacles	66 to 67	Accessories	163
Dual Key Field Attachables	68	C-Size	
Nano-Change® (M8) (US)	69	Cordsets	164 to 166
Cordsets	70 to 72	Receptacles	167 to 168
Receptacles	73 to 74	19-Pole Single and Double-Ended Cordsets	169
Field Attachable Connectors	75	19-Pole Receptacles	170
Distribution Boxes	76 to 78	Accessories	171
Snap Cordsets	79	M23	173
Ultra-Lock (EUROPE)	81	Signal	
Cordsets	82 to 86	Connectors	174 to 175
Receptacles	87 to 88	Receptacles	176 to 179
Field Attachable Connectors	89	Cordsets	180
Splitter Cordsets	90	Power	
Distribution Boxes	91 to 98	Connectors	181 to 182
Micro-Change (M12) (EUROPE)	99	Receptacles	183 to 184
Cordsets	100 to 110	Tools and Accessories	185
Receptacles	111 to 112	mPm® DIN	185
Field Attachable Connectors	113	Field Attachables	188 to 192
Solid Body Splitter and Tees	114	Molded Cables	193 to 197
Splitter Cordsets	115	Technical Features	198
Distribution Boxes	116 to 123	Available Circuit Sizes	199
Nano-Change (M8) (EUROPE)	125		
Cordsets	126 to 128		
Receptacles	129 to 130		
Field Attachable Connectors	131		
Distribution Boxes	132 to 134		
Snap Cordsets	135		

Passive media

Molex® provides a wide variety of passive media products and solutions under the Brad® name. Every connector can be trusted to perform in the most rugged, harsh-duty industrial application. Each component is designed with you in mind: field connections, quick-connect speed and simplicity, unlimited combinations of performance/power/speed/size, engineering part number system, simplified wire management products, and so much more. Molex can also provide the network and power products you need for a total system solution, each bearing the trusted Brad logo. When the infrastructure is done, you'll be glad you chose Brad, the world's leading industrial connector brand.



Built to meet the toughest industry codes and standards

Choose from five circular form factors and over four hundred application-specific cables. A three-tiered cable material solution provides welcome choices, with each material designed to meet specific application requirements. Quick-connect features save valuable time, yet fasten securely. You also have the flexibility to custom-design your own cordsets using our configuration code or standard order numbering. Our product breadth offers a complete passive media solution that includes cordsets, connectors, and distribution boxes for sensors, actuators, and bus network applications.

Performance right where it should be

The average, harsh-duty industrial environment is no place for average connectivity solutions. All Brad® automation products are designed for maximum performance and reliability in ultra-tough environments. And they're backed by the knowledge, experience and support of Molex Incorporated, a 75-year-old global manufacturer of innovative industrial communication, control and connectivity solutions.

Six circular form factors that are used globally:

- Brad Ultra-Lock® Connection System (M12)
- Brad Micro-Change® (M12)
- Brad Nano-Change® (M8)
- Brad Mini-Change® (A, B and C sizes)
- Brad M23
- Brad DIN Connectors

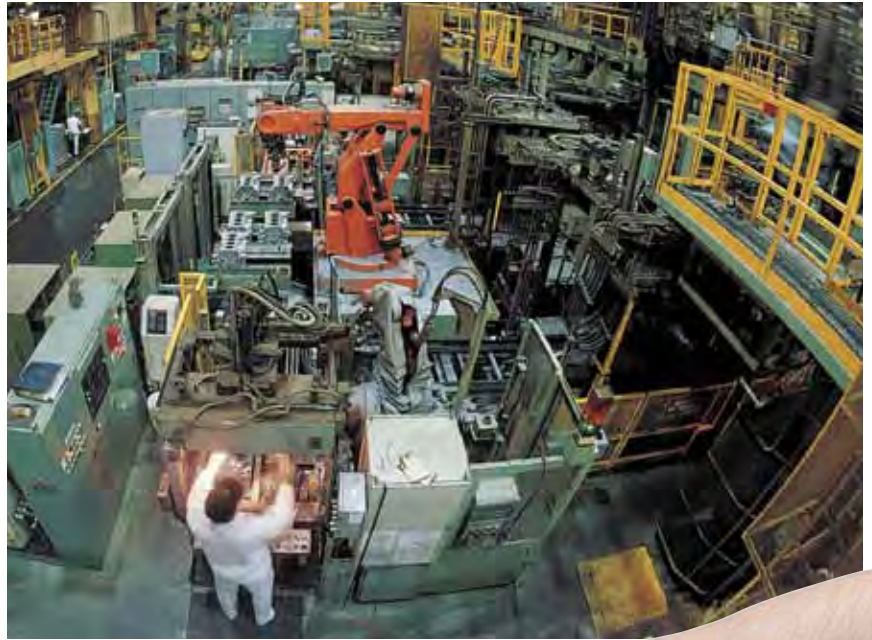

Brad® Ultra-Lock® (M12)

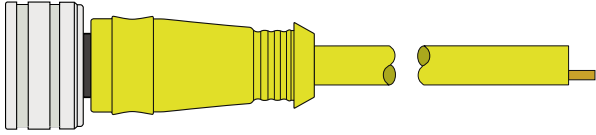

The standard for compact, push-to-lock, IP69 sealed connections for signal and communication applications

Ultra

Brad Micro-Change® (M12)

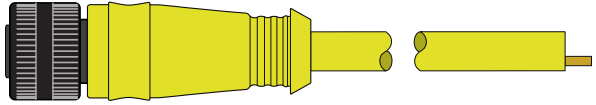

Rugged Micro-Change® connectors and receptacles provide a high-pin-density M12 solution and are ideal for use in harsh commercial and industrial environments

Micro

Brad Nano-Change® (M8)

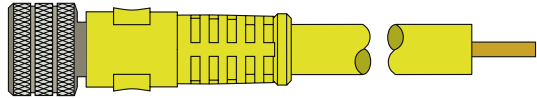

For extremely compact, rigorous connection requirements. 3, 4 and 5 pole available

Nano

Brad Mini-Change® (A, B and C sizes)

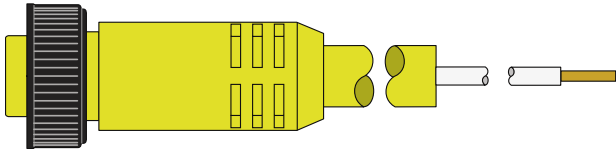

The industry standard for rugged, sealed, signal and low-power applications. 2 to 12 and 19 poles

Mini

Brad M23



Tough, metal shelled connectors for signal and power

M23

Brad mPm® DIN Cordset Family



Field attachable and Molded cable versions





DIN

The Right Cable For Your Application

Selecting the right cable for your application is very important to ensure a reliable, problem-free installation. Careful consideration of mechanical abrasion, fluid/chemical exposure, flexibility (drag chain, C-track, torsion), temperature rating and flame retardancy is required to select the cable that will provide performance and reliability in service. The Brad® line offers a complete range of cables, including five standard cable types satisfying most applications as well as 400+ application-specific cables for special performance requirements. In all cases, Brad cordsets are available in standard and non-standard lengths.

Brad PVC, PUR and TPE cordsets are manufactured with high performance materials and include UL/CSA approvals to ensure compatibility with both European and North American market requirements.

If you need assistance selecting the right cable, please contact our technical support team at your local Molex office.

APPLICATION AREA	CHARACTERISTICS
<p>PVC LIGHT INDUSTRIAL ENVIRONMENT  For use in static, less demanding environments, such as: light assembly equipment, packaging machines, conveyors</p>	<ul style="list-style-type: none"> - UL/CSA approved - Good chemical resistance - Fair resistance to abrasion - Fair oil and lubricants resistance - Inexpensive cable solution
<p>PUR/PVC MORE ROBUST ENVIRONMENT For use in assembly and production lines such as machine tools and metal-cutting production requiring higher cut, abrasion and chemical resistance</p>	<ul style="list-style-type: none"> - Good abrasion resistance - Good resistance to oils and chemicals - Flexible use in several areas - Limited usability in drag chains
<p>PUR DEMANDING ENVIRONMENTS  For use in machine tools, swivel tables and metal-cutting production with harsh fluid, mechanical or continuous flex requirements</p>	<ul style="list-style-type: none"> - UL/CSA approved - Very good resistance to oils, chemicals and coolants - High abrasion resistance - Halogen free, flame retardant - Drag chain suitability (slower motion)
<p>TPE CONTINUOUS FLEX/DEMANDING AREAS  For use in robots, special welding equipment, high speed drag chains, machine tools, assembly lines, metal cutting manufacturing</p>	<ul style="list-style-type: none"> - UL/CSA approved - Very good weld slag resistance - High temperature resistance (+105° C) - High abrasion resistance - High flex life, min. 10 million cycles bend and torsion - TC-ER, PLTC-ER or ITC-ER rated
<p>EXTRA HARD Service Cord HIGH ABUSE/PORTABLE/OUTDOOR  For use in outdoor lighting, portable tools, multi-use plant equipment, portable power and control systems</p>	<ul style="list-style-type: none"> - 105° C temperature rating - UV, ozone and water resistant - Crush and abrasion resistant - Non-wicking construction - UL/CSA type ST00W, S00W or TC-ER

Brad® Ultra-Lock® Connection System

UNITED STATES (also includes Canada, Mexico and South America)

Ultra

The performance and reliability of the revolutionary new Ultra-Lock® connection system surpass those of traditional threaded connectors, delivering increased productivity and cost savings.

Ultra-Lock connectors incorporate a unique radial seal and mechanical-locking design that deliver unsurpassed performance. The patented push-to-lock technology provides a fast, simple and secure operator-independent connection.

Ultra-Lock connectors are designed to eliminate connector-related intermittent signals in the harshest environments. Fewer intermittent signals mean less downtime and better productivity.

Ultra-Lock technology can be used on Ultra-Lock connectors as well as threaded connectors, including Brad M12 connectors from Molex and Micro-Push® (IP64) connections.

Molex offers Ultra-Lock in 3-, 4-, 5-, 8- and 12-pin configurations for an extensive assortment of cordsets, receptacles, and molded junction boxes. The Ultra-Lock receptacles and multiports can be used with conventional threaded M12 and Micro-Push products to provide backward compatibility to legacy screw-down connectors.

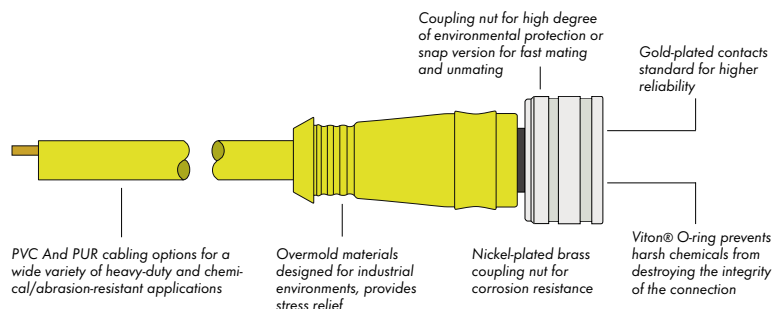

Features and Benefits

- Push-to-lock technology provides a simple, secure, operator-independent connection for fast mating and reduced installation time
- Radial O-ring provides an IP69K seal to protect against moisture
- Receptacles accept either the Ultra-Lock connector or standard M12 threaded cordsets, giving users a variety of connection options

Applications

- Proximity switches, photo eyes, safety switches and other I/O connectivity
- Connector interface for IP69-rated devices
- Connectivity for devices in high-vibration environments
- Connections requiring blind-mating

Brad® Ultra-Lock® (M12) Single-Ended Cordsets (US)

120079

Female Pigtail
Straight, Right Angle



Features and Benefits

- Push-to-lock technology assures fast, reliable connections every time
- Reliable performance in high-vibration environments due to positive locking mechanism
- Ideal for wash-down and temporary submersion applications due to improved sealing design
- Ergonomic push to lock mechanism reduces fatigue and user errors when a high number of connections need to be made
- 3-, 4-, and 5-pole versions are intermatable for added flexibility
- IP67/68/69K rated for harsh environments
- Wide selection of cables to fit applications
 - PVC cables for light, cost-sensitive industrial applications
 - PUR cables for moderate flexing and for environments encountering cutting fluids and oils
 - TPE cables for continuous-flex applications. Also ideal for welding cells, cable is weld slag resistant

Physical

Connector Body: PUR (TPE for K05)
 Contact Carries: Polyamide
 O-ring: Viton® (EPDM for E03 cables)
 Coupling Nut: Nickel-plated Brass
 (Teflon® coated for K05)
 Contacts: Copper alloy with Gold over Nickel plating
 Cables: A09—Yellow PVC jacket, 22 AWG PVC conductors, 300V, UL AWM2661
 K05—Yellow TPE jacket, 22 AWG PVC conductors, 300V, UL PLTC-ER, +10M flex life (torsion and bending)
 P02—Black PUR/PVC jacket, 24 AWG PVC conductors, 300V, 80C
 H45—Black PUR jacket, 26 AWG PVC conductors, 300V, 80C UL AWM20549

Environmental

Protection: IP67/IP68/IP69K
 NEMA rating: NEMA 6

Reference Information

CSA File No.: LR6837 (3-, 4-, and 5-pole assemblies)

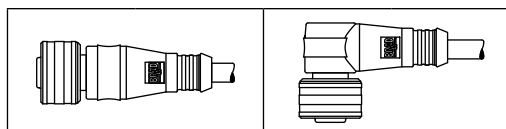

Poles	Max. Current per Contact	Max. Voltage	Cable Type	Cable Jacket (Cable Code)	Wire Size AWG	Length	Female Straight		Female Right Angle	
							Engineering No.	Standard Order No.	Engineering No.	Standard Order No.
3 Pole 	4.0A	250V AC/DC	UL 2464	PVC (A09)	22	2.0m	W03000A09M020	120079-0138	W03001A09M020	120079-0216
			PLTC-ER	TPE (K05)			W03000K05M020	120079-0130	W03001K05M020	120079-0211
4 Pole 	4.0A	250V AC/DC	UL 2464	PVC (A09)	22	2.0m	W04000A09M020	120079-0164	W04001A09M020	120079-0232
			PLTC-ER	TPE (K05)			W04000K05M020	120079-0149	W04001K05M020	120079-0221
5 Pole 	4.0A	250V AC/DC	UL 2464	PVC (A09)	22	2.0m	W05000A09M020	120079-0109	W05001A09M020	120079-0223
8 Pole 	2.0A	30V AC/36V DC		PUR/PVC (P02)	24	2.0m	W08000P02M020	120079-5113	W08001P02M020	120079-5114
12 Pole 	1.5A	30V AC/DC	UL 20549	PUR (H45)	26	2.0m	W0C000H45M020	120079-5001	W0C001H45M020	120079-5117

Note: Sales drawings for all standard order numbers are available on molex.com.

Teflon® and Viton® are registered trademarks of E.I. DuPont De Nemours and Company.

Configuration Code*
Build-a-Part Number

	Length	Code
Meters	1	M010
	2	M020
	5	M050
	10	M100

W03000A09M0208

Coupling Nut Option
Stainless Steel 8

Cable Code

*Once an engineering number is created using the configuration code, consult Molex tech support for information regarding any part numbers.

Brad® Ultra-Lock® (M12) Single-Ended Cordsets (US)

120079

Male, Pigtail
Straight, Right Angle



Features and Benefits

- Push-to-lock technology assures fast, reliable connections every time
- Reliable performance in high-vibration environments due to positive locking mechanism
- Ideal for wash-down and temporary submersion applications due to improved sealing design
- Ergonomic push-to-lock mechanism reduces fatigue and user errors when a high number of connections need to be made
- 3-, 4-, and 5-pole versions are intermatable for added flexibility
- IP67/68/69K rated for harsh environments
- Wide selection of cables to fit applications
 - PVC cables for light, cost-sensitive industrial applications
 - PUR cables for moderate flexing and for environments encountering cutting fluids and oils
 - TPE cables for continuous-flex applications. Also ideal for welding cells, cable is weld slag resistant

Physical

Connector Body: PUR (TPE for K05)
 Contact Carries: Polyamide
 O-ring: Viton® (EPDM for E03 cables)
 Coupling Nut: Nickel-plated Brass (Teflon® coated for K05)
 Contacts: Copper alloy with Gold over Nickel plating
 Cables: A09—Yellow PVC jacket, 22 AWG PVC conductors, 300V, UL AWM2661
 K05—Yellow TPE jacket, 22 AWG PVC conductors, 300V, UL PLTC-ER, +10M flex life (torsion and bending)
 P02—Black PUR/PVC jacket, 24 AWG PVC conductors, 300V, 80C
 H45—Black PUR jacket, 26 AWG PVC conductors, 300V, 80C UL AWM20549





Environmental

Protection: IP67/IP68/IP69K
 NEMA rating: NEMA 6

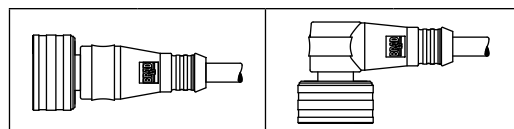
Reference Information

CSA File No.: LR6837 (3-, 4-, and 5-pole assemblies)

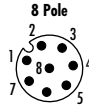

Poles (Male View)	Max. Current per Contact	Max. Voltage	Cable Type	Cable Jacket (Cable Code)	Wire Size	Length	Male Straight		Male Right Angle	
							Engineering No.	Standard Order No.	Engineering No.	Standard Order No.
	4.0A	250V AC/DC	UL 2464	PVC (A09)	22 AWG	2.0m	W03006A09M020	120079-0175	W03007A09M020	120079-0220
			PLTC-ER	TPE (K05)			W03006K05M020	120079-0155	W03007K05M020	120079-0226
	4.0A	250V AC/DC	UL 2464	PVC (A09)	22 AWG	2.0m	W04006A09M020	120079-0107	W04007A09M020	120079-0187
			PLTC-ER	TPE (K05)			W04006K05M020	120079-0156	W04007K05M020	120079-0192
	4.0A	250V AC/DC	UL 2464	PVC (A09)	22 AWG	2.0m	W05006A09M020	120079-0092	W05007A09M020	120079-0239
	2.0A	30V AC/36V DC		PUR/PVC (P02)	24 AWG	2.0m	W08006P02M020	120079-5115	W08007P02M020	120079-5116
	1.5A	30V AC/DC	UL 20549	PUR (H45)	26 AWG	2.0m	W0C006H45M020	120079-5006	W0C007H45M020	120079-5118

Note: Sales drawings for all standard order numbers are available on molex.com.
 Teflon® and Viton® are registered trademarks of E.I. DuPont De Nemours and Company.

Configuration Code*
Build-a-Part Number

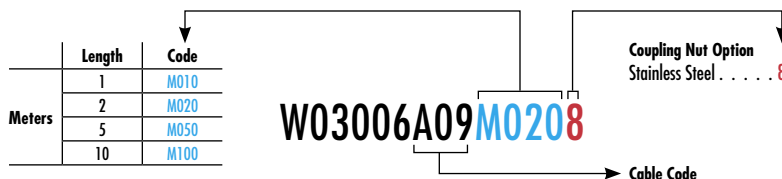

*Once an engineering number is created using the configuration code, consult Molex tech support for information regarding any part numbers.

Brad® Ultra-Lock® (M12) Double-Ended Cordsets (US)

120080

**Female Straight-to-Male Straight,
Female Right Angle-to-Male
Straight**



Features and Benefits

- Push-to-lock technology assures fast, reliable connections every time
- Reliable performance in high-vibration environments due to positive locking mechanism
- Ideal for wash-down and temporary submersion applications due to improved sealing design
- Ergonomic push-to-lock mechanism reduces fatigue and user errors when a high number of connections need to be made
- 3-, 4-, and 5-pole versions are interchangeable for added flexibility
- IP67/68/69K rated for harsh environments
- Wide selection of cables to fit applications
 - PVC cables for light, cost-sensitive industrial applications
 - PUR cables for moderate flexing and for environments encountering cutting fluids and oils
 - TPE cables for continuous-flex applications. Also ideal for welding cells, cable is weld slag resistant

Reference Information

CSA File No.: LR6837 (3-, 4-, and 5-pole assemblies)

Physical

Connector Body: PUR (TPE for K05)
 Contact Carries: Polyamide
 O-ring: Viton® (EPDM for E03 cables)
 Coupling Nut: Nickel-plated Brass
 (Teflon® coated for K05)
 Contacts: Copper alloy with Gold over Nickel plating
 Cables: A09—Yellow PVC jacket, 22 AWG PVC conductors, 300V, UL AWM2661
 K05—Yellow TPE jacket, 22 AWG PVC conductors, 300V, UL PLTC-ER, +10M flex life (torsion and bending)
 P02—Black PUR/PVC jacket, 24 AWG PVC conductors, 300V, 80C
 H45—Black PUR jacket, 26 AWG PVC conductors, 300V, 80C UL AWM20549

Environmental

Protection: IP67/IP68/IP69K
 NEMA rating: NEMA 6

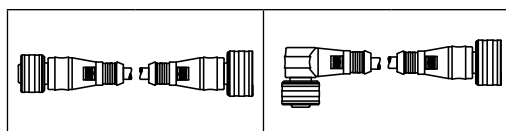

Poles (Female View)	Max. Current per Contact	Max. Voltage	Cable Type	Cable Jacket (Cable Code)	Wire Size AWG	Length	Female Straight-to-Male Straight		Female Right Angle-to-Male Straight	
							Engineering No.	Standard Order No.	Engineering No.	Standard Order No.
3 Pole 	4.0A	250V AC/DC	UL 2464	PVC (A09)	22	1.0m	WW3030A09M010	120080-0276	WW3031A09M010	120080-0429
			PLTC-ER	TPE (K05)			WW3030K05M010	120080-0414	WW3031K05M010	120080-0286
4 Pole 	4.0A	250V AC/DC	UL 2464	PVC (A09)	22	1.0m	WW4030A09M010	120080-0403	WW4031A09M010	120080-0337
			PLTC-ER	TPE (K05)			WW4030K05M010	120080-0417	WW4031K05M010	120080-0300
5 Pole 	4.0A	250V AC/DC	UL 2464	PVC (A09)	22	1.0m	WW5030A09M010	120080-0325	WW5031A09M010	120080-0382
8 Pole 	2.0A	30V AC/36V DC		PUR/PVC (P02)	24	1.0m	WW8030P02M010	120080-5083	WW8031P02M010	120080-5084
12 Pole 	1.5A	30V AC/DC	UL 20549	PUR (H45)	26	1.0m	WWC030H45M010	120080-5088	WWC031H45M010	120080-5089

Note: Sales drawings for all standard order numbers are available on molex.com.

Teflon® and Viton® are registered trademarks of E.I. DuPont De Nemours and Company.

Configuration Code*
Build-a-Part Number

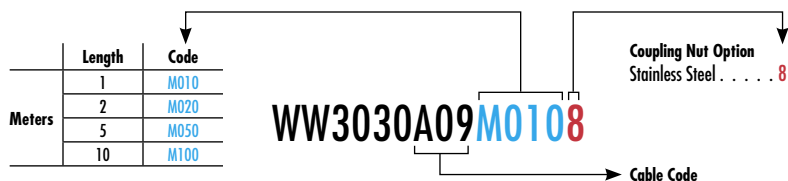

*Once an engineering number is created using the configuration code, consult Molex tech support for information regarding any part numbers.

Brad® Ultra-Lock® (M12) Double-Ended Cordsets (US)

120080

Female Straight-to-Male Right Angle, Female Right Angle-to-Male Right Angle



Features and Benefits

- Push-to-lock technology assures fast, reliable connections every time
- Reliable performance in high-vibration environments due to positive locking mechanism
- Ideal for wash-down and temporary submersion applications due to improved sealing design
- Ergonomic push-to-lock mechanism reduces fatigue and user errors when a high number of connections need to be made
- 3-, 4-, and 5-pole versions are intermatable for added flexibility
- IP67/68/69K rated for harsh environments
- Wide selection of cables to fit applications
 - PVC cables for light, cost-sensitive industrial applications
 - PUR cables for moderate flexing and for environments encountering cutting fluids and oils
 - TPE cables for continuous-flex applications. Also ideal for welding cells, cable is weld slag resistant

Physical

Connector Body: PUR (TPE for K05)
 Contact Carries: Polyamide
 O-ring: Viton® (EPDM for E03 cables)
 Coupling Nut: Nickel-plated Brass (Teflon® coated for K05)
 Contacts: Copper alloy with Gold over Nickel plating
 Cables: A09—Yellow PVC jacket, 22 AWG PVC conductors, 300V, UL AWM2661
 K05—Yellow TPE jacket, 22 AWG PVC conductors, 300V, UL PLTC-ER, +10M flex life (torsion and bending)
 P02—Black PUR/PVC jacket, 24 AWG PVC conductors, 300V, 80C
 H45—Black PUR jacket, 26 AWG PVC conductors, 300V, 80C UL AWM20549

Environmental

Protection: IP67/IP68/IP69K
 NEMA rating: NEMA 6

Reference Information

CSA File No.: LR6837 (3-, 4-, and 5-pole assemblies)

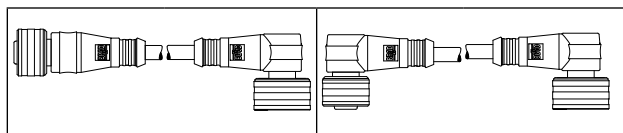

Poles (Female View)	Max. Current per Contact	Max. Voltage	Cable Type	Cable Jacket (Cable Code)	Wire Size	Length	Female Straight-to-Male Right Angle		Female Right Angle-to-Male Right Angle	
							Engineering No.	Standard Order No.	Engineering No.	Standard Order No.
	4.0A	250V AC/DC	UL 2464	PVC (A09)	22 AWG	1.0m	WW3032A09M010	120080-0419	WW3033A09M010	120080-0351
			PLTC-ER	TPE (K05)			WW3032K05M010	120080-0281	WW3033K05M010	120080-0364
	4.0A	250V AC/DC	UL 2464	PVC (A09)	22 AWG	1.0m	WW4032A09M010	120080-0347	WW4033A09M010	120080-0391
			PLTC-ER	TPE (K05)			WW4032K05M010	120080-0306	WW4033K05M010	120080-0396
	4.0A	250V AC/DC	UL 2464	PVC (A09)	22 AWG	1.0m	WW5032A09M010	120080-0378	WW5033A09M010	120080-0431
	2.0A	30V AC/36V DC		PUR/PVC (P02)	24 AWG	1.0m	WW8032P02M010	120080-5085	WW8033P02M010	120080-5086
	1.5A	30V AC/DC	UL 20549	PUR (H45)	26 AWG	1.0m	WWC032H45M010	120080-5090	WWC033H45M010	120080-5023

Note: Sales drawings for all standard order numbers are available on molex.com.
 Teflon® and Viton® are registered trademarks of E.I. DuPont De Nemours and Company.

Configuration Code*
 Build-a-Part Number

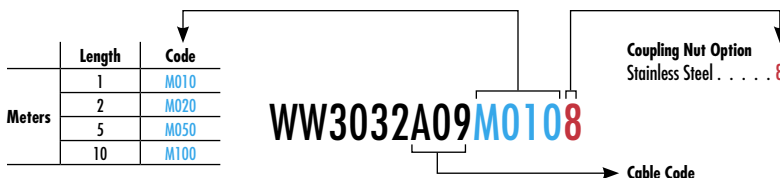

*Once an engineering number is created using the configuration code, consult Molex tech support for information regarding any part numbers.

Brad® Ultra-Lock® (M12) Single and Double-Ended Shielded Cordsets (US)

120079/120083

Female Straight, Male Straight,
Female Straight-to-Male Straight



Features and Benefits

- Push-to-lock technology assures fast, reliable connections every time
- Reliable performance in high-vibration environments due to positive locking mechanism
- Ideal for wash-down and temporary submersion applications due to improved sealing design
- Ergonomic push-to-lock mechanism reduces fatigue and user errors when a high number of connections need to be made
- Shielding thru coupling offer complete EMI protection to electrical noise
- IP67/68/69K rated for harsh environments

Physical

Connector Body: PUR
Contact Carries: Polyamide
O-ring: Viton®
Coupling: Nut Nickel-plated Brass
Contacts: Copper alloy with Gold over Nickel plating
Shielding: Braid shield on cable connected to coupler, providing complete shielding thru connector interface
Cables: P19—Black PUR jacket with braid shield, 85% coverage, 24 AWG PVC conductors, 300V, 90C
P45—Black PUR jacket with braid shield, 80% coverage, 26 AWG PVC conductors, 300V, 80C, UL AWM 20549

Environmental

Protection: IP67/IP68/IP69K
NEMA rating: NEMA 6

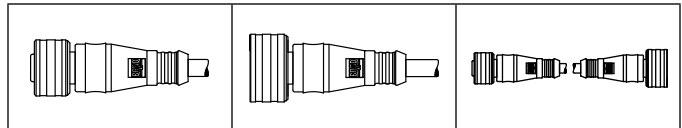

Poles (Female View)	Max. Current per Contact	Max. Voltage	Cable Type	Cable Jacket (Cable Code)	Wire Size AWG	Length	Female Straight		Male Straight		Female Straight-to-Male Straight	
							Engineering No.	Standard Order No.	Engineering No.	Standard Order No.	Engineering No.	Standard Order No.
8 Pole 	2.0A	30V AC/36V DC		PUR with Braid Shield (P19)	24	1.0m					WW8S30P19M010	120083-5183
						2.0m	W08S00P19M020	120079-5029	W08S06P19M020	120079-5033		
12 Pole 	1.5A	30V AC/DC	UL 20549	PUR with Braid Shield (P45)	26	1.0m					WWCS30P45M010	120083-5044
						2.0m	W0CS00P45M020	120083-5010	W0CS06P45M020	120083-5015		

Note: Sales drawings for all standard order numbers are available on molex.com.
Viton® is a registered trademark of E.I. DuPont De Nemours and Company.

Configuration Code*
Build-a-Part Number

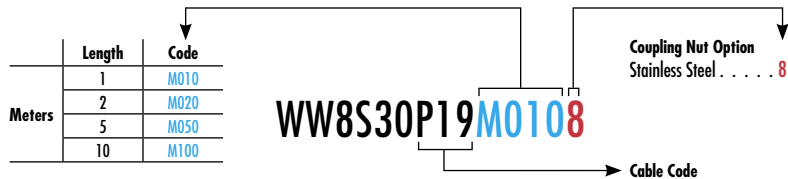

*Once an engineering number is created using the configuration code, consult Molex tech support for information regarding any part numbers.

Brad® Ultra-Lock® (M12) Receptacles (US)

120084
Female
Front Panel Mount,
Back Panel Mount



Features and Benefits

- M12 single keyway (A-Coding) IEC compliant panel mount receptacles with Ultra-Lock feature
- Mates with standard threaded M12 and Ultra-Lock cordsets
- Available in 4-, 5-, 8- and 12-pole configurations
- Fully potted assemblies provide IP67/68 protection for harsh environments
- Available in an array of configurations to fit your needs:
 - Various mounting thread sizes, including pipe threads for direct mounting on pipe fittings
 - Front panel mounts for installing from the outside of the enclosure
 - Back panel mount from inside the enclosure
 - Wire leads for terminating to terminal strips or PCB tails to incorporate with electronics

Reference Information

cCSAus Certified LR6837 (4- to 5-pole)

Physical

Shell Material: Nickel-plated Brass
 Contact Carries: Polyamide
 O-Ring: M12—Red Viton®
 Panel—Black Viton
 Contacts: Copper alloy with Gold over Nickel plating
 Wire PVC Insulation: 300V, 80° C, UL1061
 4-, 5-pole—22 AWG
 8-pole—24 AWG
 12-pole—26 AWG

Environmental

Protection: IP67
 NEMA Rating: NEMA 6

Configuration	1/2-14NPT, Front Panel Mount	M16x1.5, Front Panel Mount	M16x1.5, Back Panel Mount	M16x1.5, Back Panel Mount
Wire Type	PVC leads, UL1061	PVC leads, UL1061	PVC leads, UL1061	PCB Pins
Wire Size	22 AWG	24 AWG (8-pole), 26 AWG (12-pole)	24 AWG (8-pole), 26 AWG (12-pole)	
Length	0.3m	0.3m	0.3m	

Pole (Female View)	Max. Current per Contact	Max. Voltage	Engineering No.	Standard Order No.	Engineering No.	Standard Order No.	Engineering No.	Standard Order No.	Engineering No.	Standard Order No.
4 Pole 	4.0A	250V AC/DC	WR4000A18C300	120084-0007					WR4W400003	120084-5175
5 Pole 	4.0A	250V AC/DC	WR5000A18C300	120084-0016					WR5W400003	120084-5179
8 Pole 	2.0A	30V AC / 36V DC			WR8U20E02C3003	120084-5095	WR8W40E02C300	120084-5191	WR8W400003	120084-0048
12 Pole 	1.5A	30V AC/DC			WRCU20E01C3003	120084-5013	WRCW40E01C300	120084-5192	WRCW400003	120084-5176

Note: Sales drawings for all standard order numbers are available on molex.com.
 Viton® is a registered trademark of E.I. DuPont De Nemours and Company.

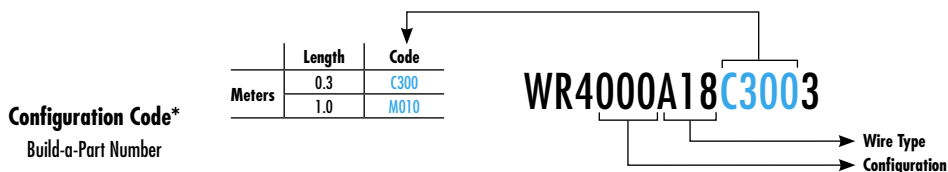

*Once an engineering number is created using the configuration code, consult Molex tech support for information regarding any part numbers.

Brad® Ultra-Lock® (M12) Receptacles (US)

120084

Male
Front Panel Mount,
Back Panel Mount



Features and Benefits

- M12 single keyway (A-Coding) IEC compliant panel mount receptacles with Ultra-Lock feature
- Mates with standard threaded M12 and Ultra-Lock cordsets
- Available in 4-, 5-, 8- and 12-pole configurations
- Fully potted assemblies provide IP67/68 protection for harsh environments
- Available in an array of configurations to fit your needs:
 - Various mounting thread sizes, including pipe threads for direct mounting on pipe fittings
 - Front panel mounts for installing from the outside of the enclosure
 - Back panel mount from inside the enclosure
 - Wire leads for terminating to terminal strips or PCB tails to incorporate with electronics

Reference Information

cSAus Certified LR6837 (4- to 5-pole)

Physical

Shell Material: Nickel-plated Brass
 Contact Carries: Polyamide
 O-Ring: Panel—Black Viton®
 Contacts: Copper alloy with Gold over Nickel plating
 Wire PVC Insulation: 300V, 80° C, UL1061
 4-, 5-pole—22 AWG
 8-pole—24 AWG
 12-pole—26 AWG

Environmental

Protection: IP67
 NEMA Rating: NEMA 6

Configuration	1/2-14NPT, Front Panel Mount		M16x1.5, Front Panel Mount		M16x1.5, Back Panel Mount		M16x1.5, Back Panel Mount			
	Wire Type	Wire Size	Wire Type	Wire Size	Wire Type	Wire Size	Wire Type	Wire Size		
	PVC leads, UL1061	22 AWG	PVC leads, UL1061	24 AWG (8-pole), 26 AWG (12-pole)	PVC leads, UL1061	24 AWG (8-pole), 26 AWG (12-pole)		PCB Pins		
	0.3m		0.3m		0.3m					
Poles	Max. Current per Contact	Max. Voltage	Engineering No.	Standard Order No.	Engineering No.	Standard Order No.	Engineering No.	Standard Order No.	Engineering No.	Standard Order No.
4 Pole 	4.0A	250V AC/DC	WR4006A18C300	120084-0008					WR4W460003	120084-5180
5 Pole 	4.0A	250V AC/DC	WR5006A18C300	120084-0017					WR5W460003	120084-5181
8 Pole 	2.0A	30V AC / 36V DC			WR8U26E02C3003	120084-5096	WR8W46E02C300	120084-5187	WR8W460003	120084-0047
12 Pole 	1.5A	30V AC/DC			WRCU26E01C3003	120084-5015	WRCW46E01C300	120084-5188	WRCW460003	120084-5182

Note: Sales drawings for all standard order numbers are available on molex.com.
 Viton® is a registered trademark of E.I. DuPont De Nemours and Company.

Configuration Code*
 Build-a-Part Number

	Length	Code
Meters	0.3	C300
	1.0	M010

WR4006A18C3003

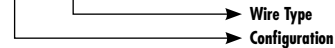

*Once an engineering number is created using the configuration code, consult Molex tech support for information regarding any part numbers.

Brad® Ultra-Lock® (M12) Field Attachable Connectors (US)

120085

**Female, Male
Straight, Right Angle**



Features and Benefits

- Allows field termination of cables to Ultra-Lock, push-to-lock connector
- Preassembled contact carries with screw terminals provides easy field termination of conductors
- Available in 4- and 5-pole versions
- Back end housing and cable gland provides IP67 protection and strain relief

Physical

Connector Body: PA
Contact Carries: PA
O-ring: Viton®
Coupling Nut: Nickel-plated Brass
Contacts: Copper alloy with Gold over Nickel plating
Termination: Screw down terminals, accepts conductors up to 18 AWG (0.75mm²)

Environmental

Protection: IP67/IP68/IP69K
NEMA Rating: NEMA 6

Female Connectors

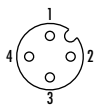
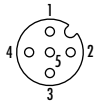
Poles	Current per Contact	Max. Voltage	Cable Diameter Range	Female Straight		Female Right Angle	
				Engineering No.	Standard Order No.	Engineering No.	Standard Order No.
	4.0A	250V AC 300V DC	3.30-6.60mm (.130-.260")	WA4000-31	120085-0011	WA4001-31	120085-0015
			4.10-8.10mm (.161-.319")	WA4000-32	120085-0013		
	4.0A	30V AC 36V DC	3.30-6.60mm (.130-.260")	WA5000-31	120085-0012	WA5001-31	120085-0016
			4.10-8.10mm (.161-.319")	WA5000-32	120085-0014		

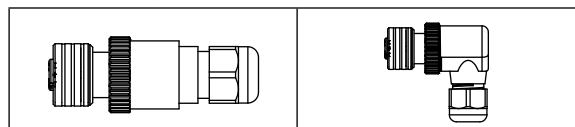

Male Connectors

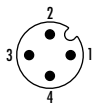
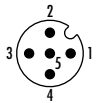
Poles	Current per Contact	Max. Voltage	Cable Diameter Range	Male Straight		Male Right Angle	
				Engineering No.	Standard Order No.	Engineering No.	Standard Order No.
	4.0A	250V AC 300V DC	3.30-6.60mm (.130-.260")	WA4006-31	120085-0003	WA4007-31	120085-0007
			4.10-8.10mm (.161-.319")	WA4006-32	120085-0005		
	4.0A	30V AC 36V DC	3.30-6.60mm (.130-.260")	WA5006-31	120085-0004	WA5007-31	120085-0008
			4.10-8.10mm (.161-.319")	WA5006-32	120085-0006		

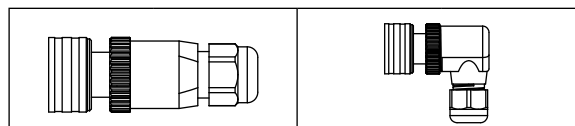

Note: Sales drawings for all standard order numbers are available on molex.com.
Viton® is a registered trademark of E.I. DuPont De Nemours and Company.

Brad® Ultra-Lock® (M12) Splitter Cordsets (US)

120080

Female Straight-to-Male Straight
Female Right Angle-to-Male
Straight



Features and Benefits

- Splitters permit the connection of two I/O devices to a Brad Ultra-Lock port on dual-wired distribution boxes
- Push-to-lock technology assures fast, reliable connections every time
- IP67/68 rated for harsh environments
- Reliable performance in high-vibration environments due to positive locking mechanism
- Wide selection of cables to fit applications
 - PVC cables for light, cost-sensitive industrial applications
 - TPE cables for continuous-flex applications. Also ideal for welding cells; cable is weld slag resistant

Reference Information

UL File No.: E152210

CSA File No.: LR6837

Physical

Connector Body: PUR (TPE for K05)

Contact Carries: Polyamide

O-ring: Viton® (EPDM for A09 cables)

Coupling Nut: Nickel-plated Brass (Teflon® coated for K05)

Contacts: Copper alloy with Gold over Nickel plating

Cables: A09—Yellow PVC jacket, 22 AWG PVC conductors, 300V, UL AWM2661

K05—Yellow TPE jacket, 22 AWG PVC conductors, 300V, UL PLTC-ER, +10M flex life (torsion and bending)

Environmental

Protection: IP67

NEMA Rating: NEMA 6

Ultra-Lock-to-Ultra-Lock Splitters

Wiring Schematic	Max. Current per Contact	Max. Voltage	Cable Type	Cable Jacket (Cable Code)	Wire Size AWG	Length	Female Straight-to-Male Straight		Female Right Angle-to-Male Straight	
							Engineering No.	Standard Order No.	Engineering No.	Standard Order No.
	4.0A	250V AC/DC	UL 2661	PVC (A09)	22	0.3m	WW4A30A09M003	120080-0001	WW4A31A09M003	120080-0005
			PLTC-ER	TPE (K05)			WW4A30K05M003	120080-0081	WW4A31K05M003	120080-0089

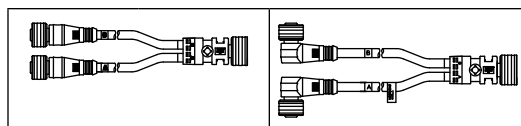

Ultra-Lock-to-Micro-Change® Splitters

Wiring Schematic	Max. Current per Contact	Max. Voltage	Cable Type	Cable Jacket (Cable Code)	Wire Size AWG	Length	Female Straight-to-Male Straight		Female Right Angle-to-Male Straight	
							Engineering No.	Standard Order No.	Engineering No.	Standard Order No.
	4.0A	250V AC/DC	UL 2661	PVC (A09)	22	0.3m	8W4A30A09M003	120080-0033	8W4A31A09M003	120080-0037
			PLTC-ER	TPE (K05)			8W4A30K05M003	120080-0108	8W4A31K05M003	120080-0116

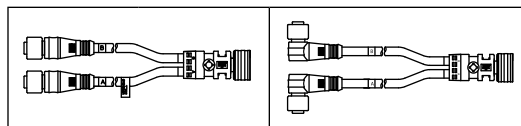

Note: Sales drawings for all standard order numbers are available on molex.com.

Teflon® and Viton® are registered trademarks of E.I. DuPont De Nemours and Company.

Configuration Code†
Build-a-Part Number

	Length	Code
Meters	0.3	M003
	0.6	M006
	1.0	M010
	3.0	M030
	5.0	M050

8W4A31K05M0038

Coupling Nut Option
Stainless Steel 8

†Once an engineering number is created using the configuration code, consult Molex tech support for information regarding any part numbers.

Brad® Ultra-Lock® (M12) Distribution Boxes (US)

120119/130008

Top Mount, Single-Wired Ports With Brad® Mini-Change® HR Connector



Features and Benefits

- Fully potted, factory assembled boxes simplify on machine wiring installations
- Accepts Ultra-Lock and threaded M12 cordsets
- One input/output per port
- Indicating LEDs for power and sensor trigger indication
- Versions available for use with PNP and NPN sensors
- Mini-Change home run connector for easy replacement

Electrical

Voltage: 10-30V DC max.
Amperage: Module—12.0A max.
Port—4.0A max.

Physical

Housing: PBT
Port Shell Material: Nickel-plated Brass
Contacts: Copper alloy with Gold over Nickel plating
Home Run Connector: Mini-Change 12-pole male connector
Wiring Configuration: Single I/O, M12 4-pole female port

Environmental

Protection: IP67
NEMA Rating: NEMA 6

Port Configuration	Box Configuration	Ports	LED Indicator	For Sensor	Top Mount	
					Engineering No.	Standard Order No.
		4	Yes	PNP	BKY401P-FBB	120119-0002
		6	Yes	PNP	BKY601P-FBB	120119-0010
		8	Yes	PNP	BKY801P-FBB	120119-0017

Suggested Home Run Cordset Mini-Change 12-pole Female Cordset

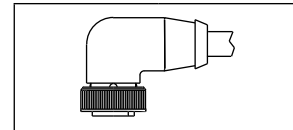

Use With	Cable Jacket	No. of Conductors	Construction	Length	Engineering No.	Standard Order No.
4-port block	PUR	7	4 × 0.34mm ² + 3 × 0.75mm ²	10.0m	302301P80M100	130008-8009
6-port block		8	6 × 0.34mm ² + 3 × 0.75mm ²		302201P80M100	130008-8006
8-port block		9	8 × 0.34mm ² + 3 × 0.75mm ²		302101P80M100	130008-0476

Note: Sales drawings for all standard order numbers are available on molex.com

Configuration Code*
Build-a-Part Number

	Length	Code
Meters	5	050
	10	100
	15	150

302301P80M100

*Once an engineering number is created using the configuration code, consult Molex tech support for information regarding any part numbers.

Brad® Ultra-Lock® (M12) Distribution Boxes (US)

120119/130008

Top Mount, Dual-Wired Ports With Brad® Mini-Change® HR Connector



Features and Benefits

- Fully potted, factory assembled boxes simplify on machine wiring installations
- Accepts Ultra-Lock and threaded M12 cordsets
- Two input/outputs per port
- Indicating LEDs for power and sensor trigger indication
- Versions available for use with PNP and NPN sensors
- Mini-Change home run connector for easy replacement

Electrical

Voltage: 10-30V DC max.
Amperage: Module—12.0A max.
Port—4.0A max.

Physical

Housing: PBT
Port Shell Material: Nickel-plated Brass
Contacts: Copper alloy with Gold over Nickel plating
Home Run Connector: Mini-Change 19-pole male connector
Wiring Configuration: Dual I/O, M12 5-pole female port

Environmental

Protection: IP67
NEMA Rating: NEMA 6

Port Configuration	Box Configuration	Ports	LED Indicator	For Sensor	Top Mount	
					Engineering No.	Standard Order No.
		4	Yes	PNP	BKY403P-FBB	120119-0005
		6	Yes	PNP	BKY603P-FBB	120119-0013
		8	Yes	PNP	BKY803P-FBB	120119-0020

Suggested Home Run Cordset Brad Mini-Change 19-pole Female Cordset

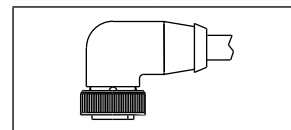

Use With	Cable Jacket	No. of Conductors	Construction	Length	Engineering No.	Standard Order No.
4- and 6-port blocks	PUR	15	12 × 0.34mm ² + 3 × 0.75mm ²	10.0m	303201P80M100	130008-5006
8-port block	PUR	19	16 × 0.34mm ² + 3 × 0.75mm ²	10.0m	303001P80M100	130008-0316

Note: Sales drawings for all standard order numbers are available on molex.com

Configuration Code*
Build-a-Part Number

	Length	Code
Meters	5	050
	10	100
	15	150

303001P80M100

*Once an engineering number is created using the configuration code, consult Molex tech support for information regarding any part numbers.

Brad® Ultra-Lock® (M12) Distribution Boxes (US)

120094

Top Mount, Single-Wired Ports With M23 HR Connector



Features and Benefits

- Fully potted, factory assembled boxes simplify on machine wiring installations
- Accepts Ultra-Lock and threaded M12 cordsets
- One input/output per port
- Indicating LEDs for power and sensor trigger indication
- Versions available for use with PNP and NPN sensors
- M23 home run connector for easy replacement

Electrical

Voltage: 10-30V DC max.
Amperage: Module—12.0A max.
Port—4.0A max.

Physical

Housing: PBT
Port Shell Material: Nickel-plated Brass
Contacts: Copper alloy with Gold over Nickel plating
Home Run Connector: M23 12-pole male connector
Wiring Configuration: Single I/O, M12 4-pole female port

Environmental

Protection: IP67
NEMA Rating: NEMA 6

Port Configuration	Box Configuration	Ports	LED Indicator	For Sensor	Top Mount	
					Engineering No.	Standard Order No.
		4	Yes	PNP	BKY401P-FBC	120119-0003
		6	Yes	PNP	BKY601P-FBC	120119-0011
		8	Yes	PNP	BKY801P-FBC	120119-0018

Suggested Home Run Cable Assemblies M23 12-pole Female Cordset and Field Attachable Connector

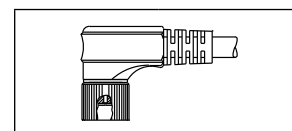

Use With	Cable Jacket	No. of Conductors	Construction	Length	Engineering No.	Standard Order No.
4-port	PUR	7	4 × 0.34mm ² + 3 × 0.75mm ²	10.0m	K02301P80M100	120094-5023
6-port		9	6 × 0.34mm ² + 3 × 0.75mm ²		K02201P80M100	120094-8013
8-port		11	8 × 0.34mm ² + 3 × 0.75mm ²		K02101P80M100	120094-0125
All		M23 12p Female Field Attachable Kit			KASCS00-025	120230-0032

Note: Sales drawings for all standard order numbers are available on molex.com

Configuration Code*
Build-a-Part Number

	Length	Code
Meters	5	050
	10	100
	15	150

K02101P80M100

*Once an engineering number is created using the configuration code, consult Molex tech support for information regarding any part numbers.

Brad® Ultra-Lock® (M12) Distribution Boxes (US)

120119/120055

Top Mount, Dual-Wired Ports With M23 HR Connector



Features and Benefits

- Fully potted, factory assembled boxes simplify on machine wiring installations
- Accepts Ultra-Lock and threaded M12 cordsets
- Two input/outputs per port
- Indicating LEDs for power and sensor trigger indication
- Versions available for use with PNP and NPN sensors
- M23 home run connector for easy replacement

Electrical

Voltage: 10-30V DC max.
Amperage: Module—12.0A max.
Port—4.0A max.

Physical

Housing: PBT
Port Shell Material: Nickel-plated Brass
Contacts: Copper alloy with Gold over Nickel plating
Home Run Connector: M23 19-pole male connector
Wiring Configuration: Dual I/O, M12 5-pole female port

Environmental

Protection: IP67
NEMA Rating: NEMA 6

Port Configuration	Box Configuration	Ports	LED Indicator	For Sensor	Top Mount	
					Engineering No.	Standard Order No.
		4	No		BKY4030-FBC	120119-0038
		8			BKY8030-FBC	120055-0925
		4	Yes	PNP	BKY403P-FBC	120119-0006
		8			BKY803P-FBC	120119-0021

Suggested Home Run Cable Assemblies M23 19-pole Female Cordset and Field Attachable Connector

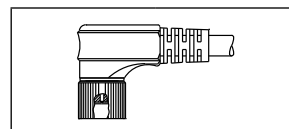

Use With	Cable Jacket	No. of Conductors	Construction	Length	Engineering No.	Standard Order No.
4-port	PUR	11	$8 \times 0.34\text{mm}^2 + 3 \times 0.75\text{mm}^2$	10.0m	K03301P80M100	120094-8045
6-port		15	$12 \times 0.34\text{mm}^2 + 3 \times 0.75\text{mm}^2$		K03201P80M100	120094-8027
8-port		19	$16 \times 0.34\text{mm}^2 + 3 \times 0.75\text{mm}^2$		K03001P80M100	120094-0044

Note: Sales drawings for all standard order numbers are available on molex.com

Configuration Code*
Build-a-Part Number

	Length	Code
Meters	5	M050
	10	M100
	15	M150

K03301P80M100

*Once an engineering number is created using the configuration code, consult Molex tech support for information regarding any part numbers.

Brad® Ultra-Lock® (M12) Distribution Boxes (US)

120119

Top Mount, Dual-Wired Ports with Field Attachable HR Terminal Strip



Features and Benefits

- Fully potted, factory assembled boxes simplify on machine wiring installations
- Accepts Ultra-Lock and threaded M12 cordsets
- Two input/outputs per port
- Indicating LEDs for power and sensor trigger indication
- Versions available for use with PNP and NPN sensors
- Home run terminal strip provides greatest flexibility for cable choices and trimming to length on machine

Physical

Housing: PBT
 Port Shell Material: Nickel-plated Brass
 Contacts: Copper alloy with Gold over Nickel plating
 Home Run Connector: Terminal strip
 Wiring Configuration: Dual I/O, M12 5-pole female

Environmental

Protection: IP67
 NEMA Rating: NEMA 6

Electrical

Voltage: 10-30V DC max.
 Amperage: Module—12.0A max.
 Port—4.0A max.

Port Configuration	Box Configuration	Ports	LED Indicator	For Sensor	Top Mount	
					Engineering No.	Standard Order No.
<p>I/O(1) V(+)* I/O(2) GRN V(-)* *Ground* *common*</p>		4	Yes	PNP	BKY403P-FBA	120119-0004
		6	Yes	PNP	BKY603P-FBA	120119-0012
		8	Yes	PNP	BKY803P-FBA	120119-0019

Brad® Ultra-Lock® (M12) Distribution Boxes (US)

120119

Top Mount, Single-Wired Ports With PUR HR Cable



Features and Benefits

- Fully potted, factory assembled boxes simplify on machine wiring installations
- Accepts Ultra-Lock and threaded M12 cordsets
- One input/output per port
- Indicating LEDs for power and sensor trigger indication
- Versions available for use with PNP and NPN sensors
- Integral home run cable eliminates need for purchase of additional component for installation

Electrical

Voltage: 10-30V DC max.
Amperage: Module—12.0A max.
Port—4.0A max.

Physical

Housing: PBT
Port Shell Material: Nickel-plated Brass
Contacts: Copper alloy with Gold over Nickel plating
Wiring Configuration: Single I/O, M12 4-pole female port
Home Run Cable: Black PUR cable, conductors:
4-port—4 × 0.34mm² + 3 × 0.75 mm²
6-port—6 × 0.34mm² + 3 × 0.75 mm²
8-port—8 × 0.34mm² + 3 × 0.75 mm²

Environmental

Protection: IP67
NEMA Rating: NEMA 6

Port Configuration	Box Configuration	Ports	LED Indicator	For Sensor	Cable Length	Top Mount	
						Engineering No.	Standard Order No.
		4	Yes	PNP	5.0m	BKY400P-FBP-05	120119-0001
		6	Yes	PNP	5.0m	BKY600P-FBP-05	120119-0009
		8	Yes	PNP	5.0m	BKY800P-FBP-05	120119-0016

Note: Sales drawings for all standard order numbers are available on molex.com

Configuration Code*
Build-a-Part Number

	Length	Code
Meters	5	05
	10	10
	15	15

BKY800P-FBP-05

*Once an engineering number is created using the configuration code, consult Molex tech support for information regarding any part numbers.

Brad® Ultra-Lock® (M12) Distribution Boxes (US)

120119

Dual-Wired Ports with PUR HR Cable



Features and Benefits

- Fully potted, factory assembled boxes simplify on machine wiring installations
- Accepts Ultra-Lock and threaded M12 cordsets
- Two input/outputs per port
- Indicating LEDs for power and sensor trigger indication
- Versions available for use with PNP and NPN sensors
- Integral home run cable eliminates need for purchase of additional component for installation

Electrical

Voltage: 10-30V DC max.
 Amperage: Module—12.0A max.
 Port—4.0A max.

Physical

Housing: PBT
 Port Shell Material: Nickel-plated Brass
 Contacts: Copper alloy with Gold over Nickel plating
 Wiring Configuration: Dual I/O, M12 5-pole female port
 Home Run Cable: Black PUR cable, conductors:
 4-port— $8 \times 0.34\text{mm}^2 + 3 \times 0.75\text{mm}^2$
 6-port— $12 \times 0.34\text{mm}^2 + 3 \times 0.75\text{mm}^2$
 8-port— $16 \times 0.34\text{mm}^2 + 3 \times 0.75\text{mm}^2$

Environmental

Protection: IP67
 NEMA Rating: NEMA 6

Port Configuration	Box Configuration	Ports	LED Indicator	For Sensor	Cable Length	Top Mount	
						Engineering No.	Standard Order No.
		4	Yes	PNP	5.0m	BKY405P-FBP-05	120119-0007
		6	Yes	PNP	5.0m	BKY605P-FBP-05	120119-0015
		8	Yes	PNP	5.0m	BKY805P-FBP-05	120119-0023

Note: Sales drawings for all standard order numbers are available on molex.com

Configuration Code*
 Build-a-Part Number

	Length	Code
Meters	5	05
	10	10
	15	15

BKY405P-FBP-05

*Once an engineering number is created using the configuration code, consult Molex tech support for information regarding any part numbers.

Brad® Ultra-Lock® (M12) Distribution Boxes (US)

120119

Top Mount, Dual-Wired Ports with Molded Brad® Mini-Change® HR Cordset



Features and Benefits

- Fully potted, factory assembled boxes simplify on machine wiring installations
- Accepts Ultra-Lock and threaded M12 cordsets
- Two input/outputs per port
- Indicating LEDs for power and sensor trigger indication
- Versions available for use with PNP and NPN sensors
- Integral home run cordset with Mini-Change 19-pole male connector provides easy replacement

Electrical

Voltage: 10-30V DC max.
Amperage: Module—12.0A max.
Port—4.0A max.

Physical

Housing: PBT
Port Shell Material: Nickel-plated Brass
Contacts: Copper alloy with Gold over Nickel plating
Wiring Configuration: Dual I/O, M12 5-pole female port
Home Run Cable: Black PUR cable, conductors:
4-port— $8 \times 0.34\text{mm}^2 + 3 \times 0.75\text{mm}^2$
6-port— $12 \times 0.34\text{mm}^2 + 3 \times 0.75\text{mm}^2$
8-port— $16 \times 0.34\text{mm}^2 + 3 \times 0.75\text{mm}^2$

Environmental

Protection: IP67
NEMA Rating: NEMA 6

Port Configuration	Box Configuration	Ports	LED Indicator	Cable Length	Top Mount	
					Engineering No.	Standard Order No.
		4	No	5.0m	BKY4120-FBP-01	120119-0008
		8	No	5.0m	BKY8120-FBP-01	120119-0025

Note: Sales drawings for all standard order numbers are available on molex.com

Configuration Code*
Build-a-Part Number

	Length	Code
Meters	5	01
	10	10
	15	15

BKY4010-FBP-01

*Once an engineering number is created using the configuration code, consult Molex tech support for information regarding any part numbers.

Brad® Micro-Change® (M12) Connectors

UNITED STATES (also includes Canada, Mexico and South America)

Rugged Micro-Change® connectors provide a high-pin-density, M12 solution that is ideal for use in industrial and harsh commercial environments.

Brad Micro-Change products are Molex's offering of rugged, high-circuit density, industry-standard M12 circular connectors for industrial automation applications.

Micro-Change connectors are designed to withstand harsh industrial environments and their superior quality assures a very reliable connection for control elements in automated equipment. These IEC 61076-2-101 compliant connectors allow fast and simple connections to 12.00 and 18.00mm sensors, encoders, switches and other input and output devices in industrial machinery.

Brad's complete line of M12 connectivity provides a quick-connect wiring system that eliminates field-install cabinets and minimizes field wiring termination errors.

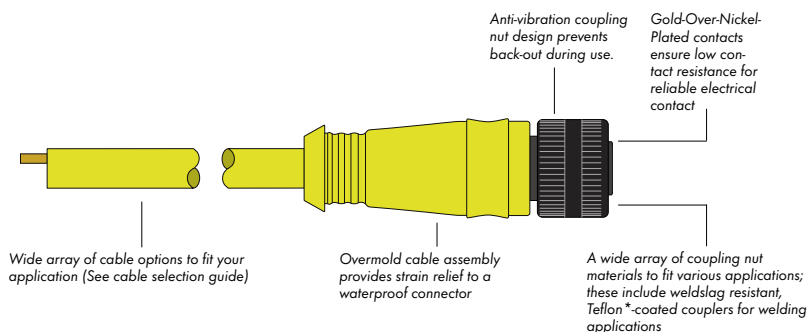

Features and Benefits Cordsets

- Available in 3-, 4-, 5-, 8- and 12-poles; in single and dual-key configurations; with or without LEDs; in straight and 90°; and with different coupling nut materials to provide a wide variety of options to meet application requirements
- Intermates with industry standard M12 devices that comply with IEC 61076-2-101
- Rugged, IP68 rated watertight connector is well suited for harsh, wet environments
- Patented, anti-vibration feature prevents back-out in applications that experience high vibration and mechanical shock
- Gold-over-nickel-plated contacts provide a durable, corrosion-resistant plating that maintains low electrical resistance throughout the life of the connector

Receptacles, Field Attachables and Accessories

- Large selection of configurations to fit your panel or device design, including front- and back-panel-mount receptacles in a variety of materials, with PCB or wire leads
- Epoxy potted receptacles are IP67- and IP68-rated, and are ideal for rugged industrial environments

- 3- to 5-pole field-attachable connectors with screw-down terminals for easy field installation, allow users to make their own cable assemblies for a custom fit to a machine or application

Distribution Boxes

- Available in 4-, 6- and 8-port distribution boxes; single and dual I/O versions. These pre-wired junction boxes comprise the Molex quick-connect wiring system for I/O devices. They eliminate the need for field-installed junction boxes, providing improved wire management
- Fully potted housing ensures performance in high-vibration and wet environment applications
- Rugged and compact to allow placement in tight places

Applications

- Proximity switches, photo eyes, safety switches and other I/O connectivity
- Connector interface for IP69-rated devices
- Connectivity for devices in high-vibration environments
- Connections requiring blind-mating

Teflon® is a registered trademark of E.I. DuPont De Nemours and Company.

Brad® Micro-Change® (M12) A-Code Single-Ended Cordsets (US)

120065

Female, Pigtail
Straight, Right Angle



Features and Benefits

- M12 Single Keyway (A-Coding) IEC compliant cordset assemblies
- 3-, 4-, and 5-pole versions are intermatable for added flexibility
- IP67/68 rated for harsh environments
- Patented anti-vibration feature to prevent loosening under high-vibration applications
- Wide selection of cables to fit applications
 - PVC cables for light, cost-sensitive industrial applications
 - PUR cables for moderate flexing and for environments encountering cutting fluids and oils
 - TPE cables for continuous-flex applications. Also ideal for welding cells; cable is weld slag resistant

Physical

Connector Body: PUR (TPE for K05)
 Contact Carries: Polyamide
 O-ring: Viton® (EPDM for A09 cables)
 Coupling Nut: Nickel-plated Brass (Teflon® coated for K05)
 Contacts: Copper alloy with Gold over Nickel plating
 Cables: A09—Yellow PVC jacket, 22 AWG PVC conductors, 300V, UL AWM2661
 K05—Yellow TPE jacket, 22 AWG PVC conductors, 300V, UL PLTC-ER, +10M flex life (torsion and bending)

Environmental

Protection: IP67
 NEMA Rating: NEMA 6

Reference Information

UL File No.: E152210

CSA File No.: LR6837

Poles	Max. Current per Contact	Max. Voltage	Cable Type	Cable Jacket (Cable Code)	Wire Size AWG	Length	Female Straight		Female Right Angle	
							Engineering No.	Standard Order No.	Engineering No.	Standard Order No.
3 Pole 1 - Brown 4 - Black 3 - Blue	4.0A	250V AC/DC	UL 2661	PVC (A09)	22	2.0m	803000A09M020	120065-0129	803001A09M020	120065-1444
			PLTC-ER	TPE (K05)			803000K05M020	120065-1108	803001K05M020	120065-1489
4 Pole 1 - Brown 3 - Blue 2 - White 4 - Black	4.0A	250V AC/DC	UL 2661	PVC (A09)	22	2.0m	804000A09M020	120065-0255	804001A09M020	120065-1551
			PLTC-ER	TPE (K05)			804000K05M020	120065-1121	804001K05M020	120065-1639
5 Pole 1 - Brown 4 - Black 2 - White 5 - Gray 3 - Blue	4.0A	250V AC/DC	UL 2661	PVC (A09)	22	2.0m	805000A09M020	120065-0471	805001A09M020	120065-1697

Note: Sales drawings for all standard order numbers are available on molex.com.

Teflon® and Viton® are registered trademarks of E.I. DuPont De Nemours and Company.

Configuration Code*
Build-a-Part Number

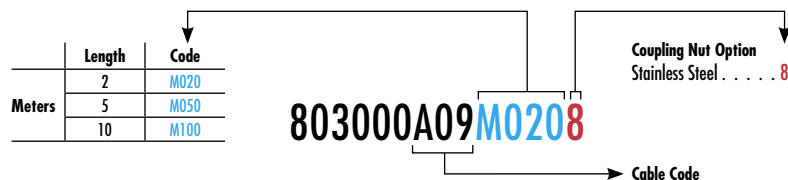

*Once an engineering number is created using the configuration code, consult Molex tech support for information regarding any part numbers.

Brad® Micro-Change® (M12) A-Code Single-Ended Cordsets (US)

120065
Female, Pigtail
Straight, Right Angle



Features and Benefits

- M12 Single Keyway (A-Coding) IEC compliant cordset assemblies
- 3-, 4-, and 5-pole versions are intermatable for added flexibility
- IP67/68 rated for harsh environments
- Patented anti-vibration feature to prevent loosening under high-vibration applications
- Wide selection of cables to fit applications
 - PVC cables for light, cost-sensitive industrial applications
 - PUR cables for moderate flexing and for environments encountering cutting fluids and oils
 - TPE cables for continuous-flex applications. Also ideal for welding cells; cable is weld slag resistant

Physical

Connector Body: PUR
 Contact Carries: Polyamide
 O-ring: Viton®
 Coupling Nut: Nickel-plated Brass
 Contacts: Copper alloy with Gold over Nickel plating
 Cables: P02—Black PUR/PVC jacket, 24 AWG PVC conductors, 300V
 H45—Black PUR jacket, 26 AWG PVC conductors, 300V, UL AWM20549

Environmental

Protection: IP67
 NEMA Rating: NEMA 6

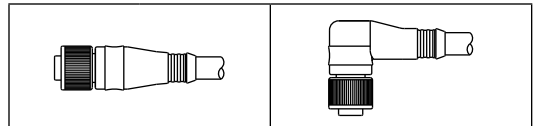

Poles	Max. Current per Contact	Max. Voltage	Cable Type	Cable Jacket (Cable Code)	Wire Size AWG	Length	Female Straight		Female Right Angle	
							Engineering No.	Standard Order No.	Engineering No.	Standard Order No.
8 Pole 1 - White 5 - Gray 2 - Brown 6 - Pink 3 - Green 7 - Blue 4 - Yellow 8 - Red	2.0A	30V AC / 36V DC		PUR/PVC (P02)	24	2.0m	808000P02M020	120065-0951	808001P02M020	120065-0960
12 Pole 1-White 5-Gray 9-Black 2-Brown 6-Pink 10-Violet 3-Green 7-Blue 11-Gray-Pink 4-Yellow 8-Red 12-Red-Blue	1.5A	30V AC/DC	UL 20549	PUR (H45)	26	2.0m	80C000H45M020	120065-5040	80C001H45M020	120065-5099

Note: Sales drawings for all standard order numbers are available on molex.com.
 Viton® is a registered trademark of E.I. DuPont De Nemours and Company.

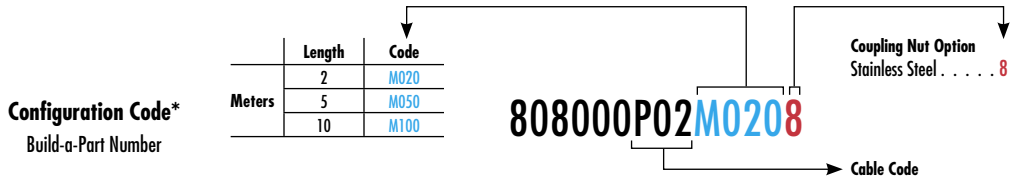

*Once an engineering number is created using the configuration code, consult Molex tech support for information regarding any part numbers.

Brad® Micro-Change® (M12) A-Code Single-Ended Cordsets (US)

120065

**Male, Pigtail
Straight, Right Angle**



Features and Benefits

- M12 Single Keyway (A-Coding) IEC compliant cordset assemblies
- 3-, 4-, and 5-pole versions are intermatable for added flexibility
- IP67/68 rated for harsh environments
- Patented anti-vibration feature to prevent loosening under high-vibration applications
- Wide selection of cables to fit applications
 - PVC cables for light, cost-sensitive industrial applications
 - PUR cables for moderate flexing and for environments encountering cutting fluids and oils
 - TPE cables for continuous-flex applications. Also ideal for welding cells; cable is weld slag resistant

Physical

Connector Body: PUR (TPE for K05)
 Contact Carries: Polyamide
 O-ring: Viton® (EPDM for A09 cables)
 Coupling Nut: Nickel-plated Brass (Teflon® coated for K05)
 Contacts: Copper alloy with Gold over Nickel plating
 Cables: A09—Yellow PVC jacket, 22 AWG PVC conductors, 300V, UL AWM2661
 K05—Yellow TPE jacket, 22 AWG PVC conductors, 300V, UL PLTC-ER, +10M flex life (torsion and bending)

Environmental

Protection: IP67
 NEMA Rating: NEMA 6

Reference Information

UL File No.: E152210 (A09 and K05 cable assemblies)
 CSA File No.: LR6837 (A09 and K05 cable assemblies)

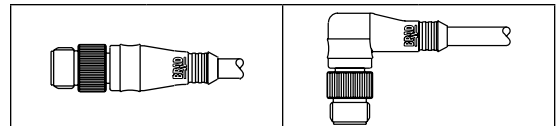

Poles	Max. Current per Contact	Max. Voltage	Cable Type	Cable Jacket (Cable Code)	Wire Size AWG	Length	Male Straight		Male Right Angle	
							Engineering No.	Standard Order No.	Engineering No.	Standard Order No.
3 Pole 1 - Brown 4 - Black 3 - Blue	4.0A	250V AC/DC	UL 2661	PVC (A09)	22	2.0m	803006A09M020	120065-0200	803007A09M020	120065-1497
			PLTC-ER	TPE (K05)			803006K05M020	120065-1114	803007K05M020	120065-1501
4 Pole 1 - Brown 3 - Blue 2 - White 4 - Black	4.0A	250V AC/DC	UL 2661	PVC (A09)	22	2.0m	804006A09M020	120065-0414	804007A09M020	120065-1662
			PLTC-ER	TPE (K05)			804006K05M020	120065-1129	804007K05M020	120065-1691
5 Pole 1 - Brown 4 - Black 2 - White 5 - Gray 3 - Blue	4.0A	250V AC/DC	UL 2661	PVC (A09)	22	2.0m	805006A09M020	120065-0523	805007A09M020	120065-1724

Note: Sales drawings for all standard order numbers are available on molex.com.
 Viton® is a registered trademark of E.I. DuPont De Nemours and Company.

Configuration Code*
 Build-a-Part Number

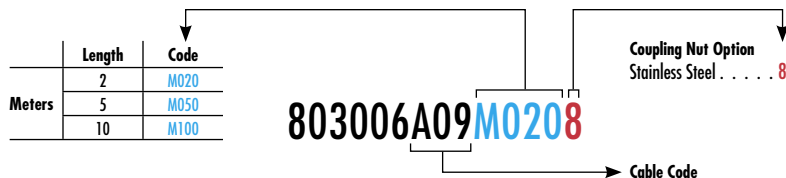

*Once an engineering number is created using the configuration code, consult Molex tech support for information regarding any part numbers.

Brad® Micro-Change® (M12) A-Code Single-Ended Cordsets (US)

120065

Male, Pigtail
Straight, Right Angle



Features and Benefits

- M12 Single Keyway (A-Coding) IEC compliant cordset assemblies
- 3-, 4-, and 5-pole versions are intermatable for added flexibility
- IP67/68 rated for harsh environments
- Patented anti-vibration feature to prevent loosening under high-vibration applications
- Wide selection of cables to fit applications
 - PVC cables for light, cost-sensitive industrial applications
 - PUR cables for moderate flexing and for environments encountering cutting fluids and oils
 - TPE cables for continuous-flex applications. Also ideal for welding cells; cable is weld slag resistant

Physical

Connector Body: PUR
 Contact Carries: Polyamide
 O-ring: Viton®
 Coupling Nut: Nickel-plated Brass
 Contacts: Copper alloy with Gold over Nickel plating
 Cables: P02—Black PUR/PVC jacket, 24 AWG PVC conductors, 300V
 H45—Black PUR jacket, 26 AWG PVC conductors, 300V, UL AWM20549

Environmental

Protection: IP67
 NEMA Rating: NEMA 6

Poles	Max. Current per Contact	Max. Voltage	Cable Type	Cable Jacket (Cable Code)	Wire Size AWG	Length	Male Straight		Male Right Angle	
							Engineering No.	Standard Order No.	Engineering No.	Standard Order No.
<p>8 Pole</p> <p>1 - White 5 - Gray 2 - Brown 6 - Pink 3 - Green 7 - Blue 4 - Yellow 8 - Red</p>	2.0A	30V AC / 36V DC		PUR/PVC (P02)	24	2.0m	808006P02M020	120065-0964	808007P02M020	120065-1800
<p>12 Pole</p> <p>1-White 5-Gray 9-Black 2-Brown 6-Pink 10-Violet 3-Green 7-Blue 11-Gray-Pink 4-Yellow 8-Red 12-Red-Blue</p>	1.5A	30V AC/DC	UL 20549	PUR (H45)	26	2.0m	80C006H45M020	120065-5045	80C007H45M020	120065-5109

Note: Sales drawings for all standard order numbers are available on molex.com.
 Viton® is a registered trademark of E.I. DuPont De Nemours and Company.

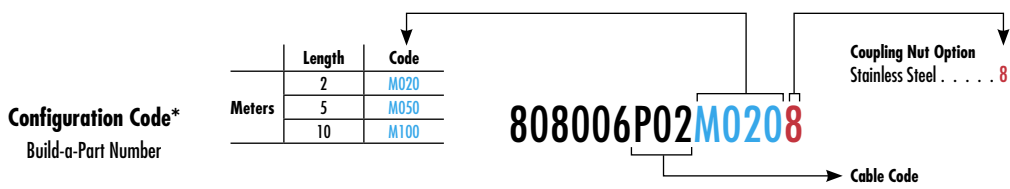

*Once an engineering number is created using the configuration code, consult Molex tech support for information regarding any part numbers.

Brad® Micro-Change® (M12) A-Code Double-Ended Cordsets (US)

120066

Female Straight-to-Male Straight, Female Right Angle-to-Male Straight



Features and Benefits

- M12 Single Keyway (A-Coding) IEC compliant cordset assemblies
- 3-, 4-, and 5-pole versions are interchangeable for added flexibility
- IP67/68 rated for harsh environments
- Patented anti-vibration feature to prevent loosening under high-vibration applications
- Wide selection of cables to fit applications
 - PVC cables for light, cost-sensitive industrial applications
 - PUR cables for moderate flexing and for environments encountering cutting fluids and oils
 - TPE cables for continuous-flex applications. Also ideal for welding cells; cable is weld slag resistant

Physical

Connector Body: PUR (TPE for K05)
 Contact Carries: Polyamide
 O-ring: Viton® (EPDM for A09 cables)
 Coupling Nut: Nickel-plated Brass (Teflon® coated for K05)
 Contacts: Copper alloy with Gold over Nickel plating
 Cables: A09—Yellow PVC jacket, 22 AWG PVC conductors, 300V, UL AWM2661
 K05—Yellow TPE jacket, 22 AWG PVC conductors, 300V, UL PLTC-ER, +10M flex life (torsion and bending)

Environmental

Protection: IP67
 NEMA Rating: NEMA 6

Reference Information

UL File No.: E152210
 CSA File No.: LR6837

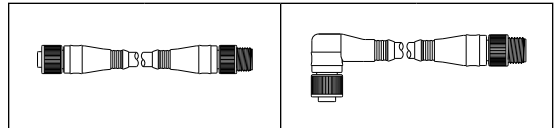

Poles (Female View)	Max. Current per Contact	Max. Voltage	Cable Type	Cable Jacket (Cable Code)	Wire Size AWG	Length	Female Straight-to-Male Straight		Female Right Angle-to-Male Straight	
							Engineering No.	Standard Order No.	Engineering No.	Standard Order No.
3 Pole 1 - Brown 4 - Black 3 - Blue	4.0A	250V AC/DC	UL 2661	PVC (A09)	22	1.0m	883030A09M010	120066-0166	883031A09M010	120066-1137
			PLTC-ER	TPE (K05)			883030K05M010	120066-0676	883031K05M010	120066-0222
4 Pole 1 - Brown 3 - Blue 2 - White 4 - Black	4.0A	250V AC/DC	UL 2661	PVC (A09)	22	1.0m	884030A09M010	120066-0266	884031A09M010	120066-1262
			PLTC-ER	TPE (K05)			884030K05M010	120066-0687	884031K05M010	120066-0376
5 Pole 1 - Brown 4 - Black 2 - White 5 - Gray 3 - Blue	4.0A	250V AC/DC	UL 2661	PVC (A09)	22	1.0m	885030A09M010	120066-0427	885031A09M010	120066-1389

Note: Sales drawings for all standard order numbers are available on molex.com.
 Teflon® and Viton® are registered trademarks of E.I. DuPont De Nemours and Company.

Configuration Code*
 Build-a-Part Number

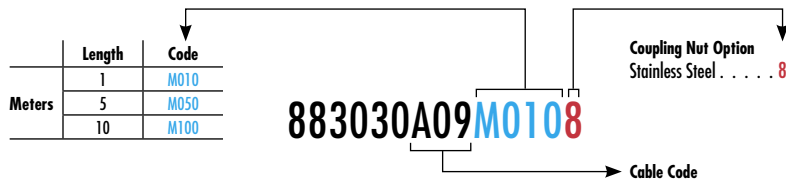

*Once an engineering number is created using the configuration code, consult Molex tech support for information regarding any part numbers.

Brad® Micro-Change® (M12) A-Code Double-Ended Cordsets (US)

120066

Female Straight-to-Male Straight, Female Right Angle-to-Male Straight



Features and Benefits

- M12 Single Keyway (A-Coding) IEC compliant cordset assemblies
- 3-, 4-, and 5-pole versions are intermatable for added flexibility
- IP67/68 rated for harsh environments
- Patented anti-vibration feature to prevent loosening under high-vibration applications
- Wide selection of cables to fit applications
 - PVC cables for light, cost-sensitive industrial applications
 - PUR cables for moderate flexing and for environments encountering cutting fluids and oils
 - TPE cables for continuous-flex applications. Also ideal for welding cells; cable is weld slag resistant

Physical

Connector Body: PUR
 Contact Carries: Polyamide
 O-ring: Viton®
 Coupling Nut: Nickel-plated Brass
 Contacts: Copper alloy with Gold over Nickel plating
 Cables: P02—Black PUR/PVC jacket, 24 AWG PVC conductors, 300V
 H45—Black PUR jacket, 26 AWG PVC conductors, 300V, UL AWM20549

Environmental

Protection: IP67
 NEMA Rating: NEMA 6

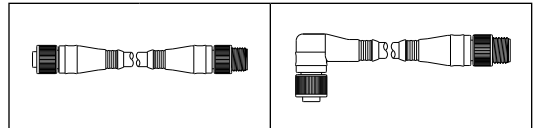

Poles (Female View)	Max. Current per Contact	Max. Voltage	Cable Type	Cable Jacket (Cable Code)	Wire Size AWG	Length	Female Straight-to-Male Straight		Female Right Angle-to-Male Straight	
							Engineering No.	Standard Order No.	Engineering No.	Standard Order No.
8 Pole 1 - White 5 - Gray 2 - Brown 6 - Pink 3 - Green 7 - Blue 4 - Yellow 8 - Red	2.0A	30V AC / 36V DC		PUR/PVC (P02)	24	1.0m	888030P02M010	120066-0579	888031P02M010	120066-1626
12 Pole 1-White 5-Gray 9-Black 2-Brown 6-Pink 10-Violet 3-Green 7-Blue 11-Gray-Pink 4-Yellow 8-Red 12-Red-Blue	1.5A	30V AC/DC	UL 20549	PUR (H45)	26	1.0m	88C030H45M010	120066-5404	88C031H45M010	120066-5405

Note: Sales drawings for all standard order numbers are available on molex.com.
 Viton® is a registered trademark of E.I. DuPont De Nemours and Company.

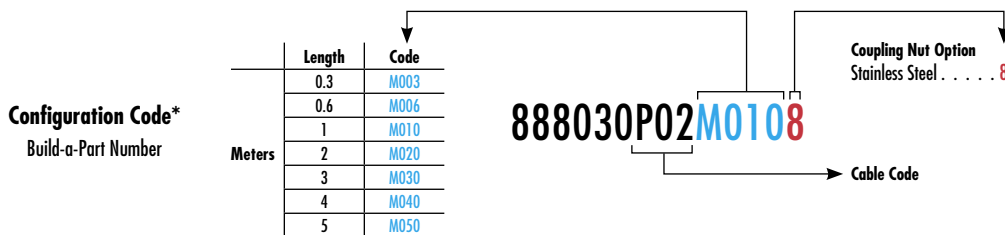

*Once an engineering number is created using the configuration code, consult Molex tech support for information regarding any part numbers.

Brad® Micro-Change® (M12) A-Code Double-Ended Cordsets (US)

120066

Female Straight-to-Male Right Angle, Female Right Angle-to-Male Right Angle



Features and Benefits

- M12 Single Keyway (A-Coding) IEC compliant cordset assemblies
- 3-, 4-, and 5-pole versions are intermatable for added flexibility
- IP67/68 rated for harsh environments
- Patented anti-vibration feature to prevent loosening under high-vibration applications
- Wide selection of cables to fit applications
 - PVC cables for light, cost-sensitive industrial applications
 - PUR cables for moderate flexing and for environments encountering cutting fluids and oils
 - TPE cables for continuous-flex applications. Also ideal for welding cells; cable is weld slag resistant

Physical

Connector Body: PUR (TPE for K05)
 Contact Carries: Polyamide
 O-ring: Viton® (EPDM for A09 cables)
 Coupling Nut: Nickel-plated Brass (Teflon® coated for K05)
 Contacts: Copper alloy with Gold over Nickel plating
 Cables: A09—Yellow PVC jacket, 22 AWG PVC conductors, 300V, UL AWM2661
 K05—Yellow TPE jacket, 22 AWG PVC conductors, 300V, UL PLTC-ER, +10M flex life (torsion and bending)

Environmental

Protection: IP67
 NEMA Rating: NEMA 6

Reference Information

UL File No.: E152210
 CSA File No.: LR6837

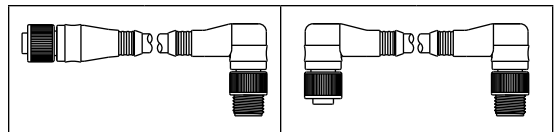

Poles (Female View)	Max. Current per Contact	Max. Voltage	Cable Type	Cable Jacket (Cable Code)	Wire Size AWG	Length	Female Straight-to-Male Right Angle		Female Right Angle-to-Male Right Angle	
							Engineering No.	Standard Order No.	Engineering No.	Standard Order No.
3 Pole 1 - Brown 4 - Black 3 - Blue	4.0A	250V AC/DC	UL 2661	PVC (A09)	22	1.0m	883032A09M010	120066-1177	883033A09M010	120066-1199
			PLTC-ER	TPE (K05)			883032K05M010	120066-0231	883033K05M010	120066-1223
4 Pole 1 - Brown 3 - Blue 2 - White 4 - Black	4.0A	250V AC/DC	UL 2661	PVC (A09)	22	1.0m	884032A09M010	120066-1307	884033A09M010	120066-1336
			PLTC-ER	TPE (K05)			884032K05M010	120066-0400	884033K05M010	120066-1382
5 Pole 1 - Brown 4 - Black 2 - White 5 - Gray 3 - Blue	4.0A	250V AC/DC	UL 2661	PVC (A09)	22	1.0m	885032A09M010	120066-1399	885033A09M010	120066-1634

Note: Sales drawings for all standard order numbers are available on molex.com.
 Teflon® and Viton® are registered trademarks of E.I. DuPont De Nemours and Company.

Configuration Code*
 Build-a-Part Number

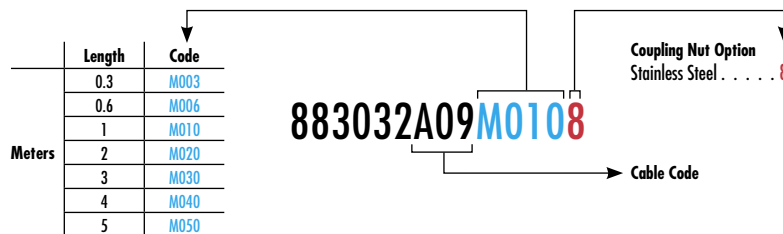

*Once an engineering number is created using the configuration code, consult Molex tech support for information regarding any part numbers.

Brad® Micro-Change® (M12) A-Code Double-Ended Cordsets (US)

120066

Female Straight-to-Male Right Angle, Female Right Angle-to-Male Right Angle



Features and Benefits

- M12 Single Keyway (A-Coding) IEC compliant cordset assemblies
- 3-, 4-, and 5-pole versions are intermatable for added flexibility
- IP67/68 rated for harsh environments
- Patented anti-vibration feature to prevent loosening under high-vibration applications
- Wide selection of cables to fit applications
 - PVC cables for light, cost-sensitive industrial applications
 - PUR cables for moderate flexing and for environments encountering cutting fluids and oils
 - TPE cables for continuous-flex applications. Also ideal for welding cells; cable is weld slag resistant

Physical

Connector Body: PUR
 Contact Carries: Polyamide
 O-ring: Viton®
 Coupling Nut: Nickel-plated Brass
 Contacts: Copper alloy with Gold over Nickel plating
 Cables: P02—Black PUR/PVC jacket, 24 AWG PVC conductors, 300V
 H45—Black PUR jacket, 26 AWG PVC conductors, 300V, UL AWM20549

Environmental

Protection: IP67
 NEMA Rating: NEMA 6

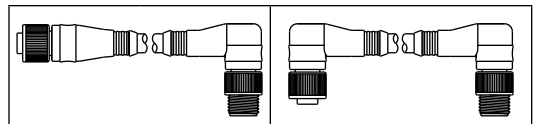

Poles (Female View)	Max. Current per Contact	Max. Voltage	Cable Type	Cable Jacket (Cable Code)	Wire Size AWG	Length	Female Straight-to-Male Right Angle		Female Right Angle-to-Male Right Angle	
							Engineering No.	Standard Order No.	Engineering No.	Standard Order No.
8 Pole 1 - White 5 - Gray 2 - Brown 6 - Pink 3 - Green 7 - Blue 4 - Yellow 8 - Red	2.0A	30V AC / 36V DC		PUR/PVC (P02)	24	1.0m	888032P02M010	120066-5403	888033P02M010	120066-0479
12 Pole 1-White 5-Gray 9-Black 2-Brown 6-Pink 10-Violet 3-Green 7-Blue 11-Gray-Pink 4-Yellow 8-Red 12-Red-Blue	1.5A	30V AC/DC	UL 20549	PUR (H45)	26	1.0m	88C032H45M010	120066-5406	88C033H45M010	120066-5407

Note: Sales drawings for all standard order numbers are available on molex.com.
 Viton® is a registered trademark of E.I. DuPont De Nemours and Company.

Configuration Code*
 Build-a-Part Number

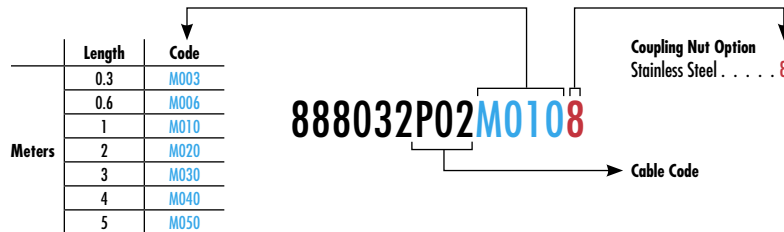

*Once an engineering number is created using the configuration code, consult Molex tech support for information regarding any part numbers.

Brad® Micro-Change® (M12) A-Code Single-Ended Cordsets (US)

120067

Female, Pigtail
Straight, Right Angle
With LEDs



Features and Benefits

- M12 single keyway (A-Coding) IEC compliant cordset assemblies
- LEDs for power and signal trigger indicator for PNP sensors (for NPN sensors also available)
- IP67/68 rated for harsh environments
- Patented anti-vibration feature to prevent loosening under high-vibration applications
- Wide selection of cables to fit applications
 - PVC cables for light, cost-sensitive industrial applications
 - PUR cables for moderate flexing and for environments encountering cutting fluids and oils
 - TPE cables for continuous-flex applications. Also ideal for welding cells; cable is weld slag resistant

Reference Information

UL File No.: E152210
CSA File No.: LR6837

Physical

Connector Body: PUR (TPE for K05)
Contact Carries: Polyamide
O-ring: Viton® (EPDM for A09 cables)
Coupling Nut: Nickel-plated Brass (Teflon® coated for K05)
Contacts: Copper alloy with Gold over Nickel plating
LEDs: Green—Power
Yellow—Sensor/output trigger
Cables: A09—Yellow PVC jacket, 22 AWG PVC conductors, 300V, UL AWM2661
B03—Black PUR jacket, 22 AWG PVC conductors, 300V, UL AWM 21198
K05—Yellow TPE jacket, 22 AWG PVC conductors, 300V, UL PLTC-ER, +10M flex life (torsion and bending)

Environmental

Protection: IP67
NEMA Rating: NEMA 6

Poles	Max. Current per Contact	Max. Voltage	Cable Type	Cable Jacket (Cable Code)	Wire Size AWG	Length	Female Straight		Female Right Angle	
							Engineering No.	Standard Order No.	Engineering No.	Standard Order No.
3 Poles/1 LED 1 - Brown 4 - Black 3 - Blue	4.0A	250V AC/DC	UL 2661	PVC (A09)	22	2.0m	8030P0A09M020	120067-0185	8030P1A09M020	120067-0227
			UL 21198	PUR (B03)			8030P0B03M020	120067-0192	8030P1B03M020	120067-0241
			PLTC-ER	TPE (K05)			8030P0K05M020	120067-5228	8030P1K05M020	120067-0198
4 Poles/1 LED 1 - Brown 3 - Blue 2 - White 4 - Black	4.0A	250V AC/DC	UL 2661	PVC (A09)	22	2.0m	8040P0A09M020	120067-0027	8040P1A09M020	120067-0257
			UL 21198	PUR (B03)			8040P0B03M020	120067-5229	8040P1B03M020	120067-5231
			PLTC-ER	TPE (K05)			8040P0K05M020	120067-5230	8040P1K05M020	120067-5232

Note: Sales drawings for all standard order numbers are available on molex.com.
Teflon® and Viton® are registered trademarks of E.I. DuPont De Nemours and Company.

Configuration Code*
Build-a-Part Number



*Once an engineering number is created using the configuration code, consult Molex tech support for information regarding any part numbers.

Brad® Micro-Change® (M12) A-Code Double-Ended Cordsets (US)

120067

Female Straight-to-Male Straight with LEDs, Female Right Angle-to-Male Straight with LEDs



Features and Benefits

- M12 single keyway (A-Coding) IEC compliant cordset assemblies
- LEDs for power and signal trigger indicator for PNP sensors (for NPN sensors also available)
- IP67/68 rated for harsh environments
- Patented anti-vibration feature to prevent loosening under high-vibration applications
- Wide selection of cables to fit applications
 - PVC cables for light, cost-sensitive industrial applications
 - PUR cables for moderate flexing and for environments encountering cutting fluids and oils
 - TPE cables for continuous-flex applications. Also ideal for welding cells; cable is weld slag resistant

Reference Information

UL File No.: E152210
CSA File No.: LR6837

Physical

Connector Body: PUR (TPE for K05)
Contact Carries: Polyamide
O-ring: Viton® (EPDM for A09 cables)
Coupling Nut: Nickel-plated Brass (Teflon® coated for K05)
Contacts: Copper alloy with Gold over Nickel plating
LEDs: Green—Power
Yellow—Sensor/output trigger
Cables: A09—Yellow PVC jacket, 22 AWG PVC conductors, 300V, UL AWM2661
B03—Black PUR jacket, 22 AWG PVC conductors, 300V, UL AWM 21198
K05—Yellow TPE jacket, 22 AWG PVC conductors, 300V, UL PLTC-ER, +10M flex life (torsion and bending)

Environmental

Protection: IP67
NEMA Rating: NEMA 6

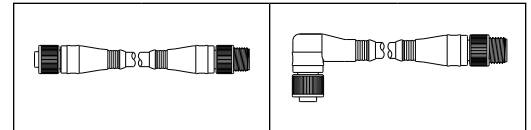

Poles (Female View)	Max. Current per Contact	Max. Voltage	Cable Type	Cable Jacket (Cable Code)	Wire Size AWG	Length	Female Straight-to-Male Straight		Female Right Angle-to-Male Straight	
							Engineering No.	Standard Order No.	Engineering No.	Standard Order No.
3 poles/1 LED 1 - Brown 4 - Black 3 - Blue	4.0A	250V AC/DC	UL 2661	PVC (A09)	22	1.0m	8830P6A09M010	120067-0037	8830P7A09M010	120067-0046
			UL 21198	PUR (B03)			8830P6B03M010	120067-5233	8830P7B03M010	120067-0058
			PLTC-ER	TPE (K05)			8830P6K05M010	120067-0040	8830P7K05M010	120067-0065
3 poles/1 LED 1 - Brown 3 - Blue 2 - White 4 - Black	4.0A	250V AC/DC	UL 2661	PVC (A09)	22	1.0m	8840P6A09M010	120067-0095	8840P7A09M010	120067-0107
			UL 21198	PUR (B03)			8840P6B03M010	120067-5240	8840P7B03M010	120067-0112
			PLTC-ER	TPE (K05)			8840P6K05M010	120067-0101	8840P7K05M010	120067-0117

Note: Sales drawings for all standard order numbers are available on molex.com.
Teflon® and Viton® are registered trademarks of E.I. DuPont De Nemours and Company.

Configuration Code*
Build-a-Part Number

Length	Code
1	M010
5	M050
10	M100

8830P6A09M0108

Coupling Nut Option
Stainless Steel 8

Cable Code

*Once an engineering number is created using the configuration code, consult Molex tech support for information regarding any part numbers.

Brad® Micro-Change® (M12) A-Code Double-Ended Cordsets (US)

120067

Female Straight-to-Male Right Angle with LEDs, Female Right Angle-to-Male Right Angle with LEDs



Features and Benefits

- M12 single keyway (A-Coding) IEC compliant cordset assemblies
- LEDs for power and signal trigger indicator for PNP sensors (for NPN sensors also available)
- IP67/68 rated for harsh environments
- Patented anti-vibration feature to prevent loosening under high-vibration applications
- Wide selection of cables to fit applications
 - PVC cables for light, cost-sensitive industrial applications
 - PUR cables for moderate flexing and for environments encountering cutting fluids and oils
 - TPE cables for continuous-flex applications. Also ideal for welding cells; cable is weld slag resistant

Reference Information

UL File No.: E152210
CSA File No.: LR6837

Physical

Connector Body: PUR (TPE for K05)
Contact Carries: Polyamide
O-ring: Viton® (EPDM for A09 cables)
Coupling Nut: Nickel-plated Brass (Teflon® coated for K05)
Contacts: Copper alloy with Gold over Nickel plating
LEDs: Green—Power
Yellow—Sensor/output trigger
Cables: A09—Yellow PVC jacket, 22 AWG PVC conductors, 300V, UL AWM2661
B03—Black PUR jacket, 22 AWG PVC conductors, 300V, UL AWM 21198
K05—Yellow TPE jacket, 22 AWG PVC conductors, 300V, UL PLTC-ER, +10M flex life (torsion and bending)

Environmental

Protection: IP67
NEMA Rating: NEMA 6

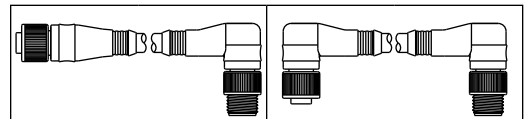

Poles (Female View)	Max. Current per Contact	Max. Voltage	Cable Type	Cable Jacket (Cable Code)	Wire Size AWG	Length	Female Straight-to-Male Right Angle		Female Right Angle-to-Male Right Angle	
							Engineering No.	Standard Order No.	Engineering No.	Standard Order No.
3 poles/1 LED 1 - Brown 4 - Black 3 - Blue	4.0A	250V AC/DC	UL 2661	PVC (A09)	22	1.0m	8830P8A09M010	120067-5235	8830P9A09M010	120067-0074
			UL 21198	PUR (B03)			8830P8B03M010	120067-5236	8830P9B03M010	120067-5239
			PLTC-ER	TPE (K05)			8830P8K05M010	120067-0072	8830P9K05M010	120067-0079
4 poles/1 LED 1 - Brown 3 - Blue 2 - White 4 - Black	4.0A	250V AC/DC	UL 2661	PVC (A09)	22	1.0m	8840P8A09M010	120067-5242	8840P9A09M010	120067-5246
			UL 21198	PUR (B03)			8840P8B03M010	120067-5243	8840P9B03M010	120067-5247
			PLTC-ER	TPE (K05)			8840P8K05M010	120067-0122	8840P9K05M010	120067-5249

Note: Sales drawings for all standard order numbers are available on molex.com.
Teflon® and Viton® are registered trademarks of E.I. DuPont De Nemours and Company.

Configuration Code*
Build-a-Part Number

Length	Code
0.3	M003
0.6	M006
1	M010
2	M020
3	M030
4	M040
5	M050

Coupling Nut Option	Code
Stainless Steel	8

8830P8A09M0108

→ Cable Code

*Once an engineering number is created using the configuration code, consult Molex tech support for information regarding any part numbers.

Brad® Micro-Change® (M12) A-Code Receptacles (US)

120070/120011

Female
Front Panel Mount, Back Panel Mount



Features and Benefits

- M12 Single Keyway (A-Coding) IEC compliant panel mount receptacles
- Available in 3-, 4-, 5- and 8-pole configurations
- Fully potted assemblies provide IP67/68 protection for harsh environments
- Available in an array of configurations to fit your needs:
 - Various mounting thread sizes, including pipe threads for direct mounting on pipe fittings
 - Front panel mounts for installing from the outside of the enclosure
 - Back panel mount from inside the enclosure
 - Wire leads for terminating to terminal strips or PCB tails to incorporate with electronics

Physical

Shell Material: Nickel-plated Brass (PG9 style)
Zinc/Nickel-plated (1/2" style)
Anodized Alum (1/4" style)
Contact Carries: Polyamide
O-Ring: M12—Red Viton®
Panel—Black Viton
Contacts: Copper alloy with Gold over Nickel plating
Wire PVC Insulation: 300V, 80C, UL1061, 22 AWG (3-5 pole) and 24 AWG (8 pole)

Environmental

Protection: IP67
NEMA Rating: NEMA 6

Reference Information

UL File No.: E152210
CSA File No.: LR6837

Configuration		1/2-14NPT, Front Panel Mount		1/4-18NPT, Front Panel Mount		PG9, Front Panel Mount		PG9, Back Panel Mount		
Wire Type	Wire Size	Length	Engineering No.	Standard Order No.	Engineering No.	Standard Order No.	Engineering No.	Standard Order No.	Engineering No.	Standard Order No.
PVC leads, UL1061	22 AWG	12"	8R3000A18A120	120070-5200	8R3A00A18A120	120070-0056			8R3J400013	120070-5203
PVC leads, UL1061	22 AWG	12"	8R4000A18A120	120070-0173	8R4A00A18A120	120070-0114			8R4J400013	120011-0237
PVC leads, UL1061	24 AWG	0.3m	8R5000A18A120	120070-5206	8R5A00A18A120	120070-0201			8R5J400013	120011-0238
							8R8J20E02C3003	120070-5208	8R8J400013	120070-5210

Note: Sales drawings for all standard order numbers are available on molex.com.
Viton® is a registered trademark of E.I. DuPont De Nemours and Company.

Configuration Code*
Build-a-Part Number

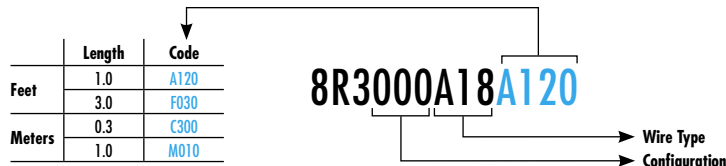

*Once an engineering number is created using the configuration code, consult Molex tech support for information regarding any part numbers.

Brad® Micro-Change® (M12) A-Code Receptacles (US)

120070/120011

Male
Front Panel Mount,
Back Panel Mount



Features and Benefits

- M12 Single Keyway (A-Coding) IEC compliant panel mount receptacles
- Available in 3-, 4-, 5- and 8-pole configurations
- Fully potted assemblies provide IP67/68 protection for harsh environments
- Available in an array of configurations to fit your needs:
 - Various mounting thread sizes, including pipe threads for direct mounting on pipe fittings
 - Front panel mounts for installing from the outside of the enclosure
 - Back panel mount from inside the enclosure
 - Wire leads for terminating to terminal strips or PCB tails to incorporate with electronics

Physical

Shell Material: Nickel-plated Brass (PG9 style)
Anodized Alum (1/2" style)

Contact Carries: Polyamide

O-Ring: Panel—Black Viton®

Contacts: Copper alloy with Gold over Nickel plating

Wire PVC Insulation: 300V, 80° C, UL1061, 22 AWG (3-5 pole) and 24 AWG (8 pole)

Environmental

Protection: IP67

NEMA Rating: NEMA 6

Reference Information

UL File No.: E152210

CSA File No.: LR6837

Configuration	1/2-14NPT, Front Panel Mount		PG9, Front Panel Mount		PG9, Back Panel Mount			
	Wire Type	Wire Size	Wire Type	Wire Size	PCB Pins			
	PVC leads, UL1061	22 AWG	PVC leads, UL1061	24 AWG				
	Length 12"		Length 0.3m					
Pole (Male View)	Max. Current per Contact	Max. Voltage	Engineering No.	Standard Order No.	Engineering No.	Standard Order No.	Engineering No.	Standard Order No.
3 Pole 	4.0A	250V AC/DC	8R3006A18A120	120070-0093			8R3J460003	120070-5204
4 Pole 	4.0A	250V AC/DC	8R4006A18A120	120070-0184			8R4J460003	120011-0281
5 Pole 	4.0A	250V AC/DC	8R5006A18A120	120070-0252			8R5J460003	120070-0235
8 Pole 	2.0A	30V AC / 36V DC			8R8J26E02C3003	120070-5209	8R8J460003	120070-5180

Note: Sales drawings for all standard order numbers are available on molex.com.
Viton® is a registered trademark of E.I. DuPont De Nemours and Company.

Configuration Code*
Build-a-Part Number

	Length	Code
Feet	1.0	A120
	3.0	F030
Meters	0.3	C300
	1.0	M010

8R3006A18A120

Wire Type Configuration

*Once an engineering number is created using the configuration code, consult Molex tech support for information regarding any part numbers.

Brad® Micro-Change® (M12) A-Code Field Attachable Connectors (US)

120071

Female, Male
Straight, Right Angle



Features and Benefits

- Allows field termination of cables to IEC compliant M12 A-Coding connector
- Preassembled contact carries with screw terminals provides easy field termination of conductors
- Available in 4 and 5-pole versions
- Back end housing and cable gland provides IP67 protection and strain relief

Physical

Connector Body: PA
Contact Carries: PA
O-ring: Viton®
Coupling Nut: Nickel-plated Brass
Contacts: Copper alloy with Gold over Nickel plating
Termination: Screw down terminals, accepts conductors up to 18 AWG (0.75mm²)

Environmental

Protection: IP67
NEMA Rating: NEMA 6

Female Connectors

Poles	Current per Contact	Max. Voltage	Cable Diameter Range	Female Straight		Female Right Angle	
				Engineering No.	Standard Order No.	Engineering No.	Standard Order No.
	4.0A	250V AC 300V DC	3.30-6.60mm (.130-.260")	8A4000-31	120071-0035	8A4001-31	120071-0037
			4.10-8.10mm (.161-.319")	8A4000-32	120071-0036		
	4.0A	30V AC 36V DC	3.30-6.60mm (.130-.260")	8A5000-31	120071-0041	8A5001-31	120071-0044
			4.10-8.10mm (.161-.319")	8A5000-32	120071-0043		

Male Connectors

Poles	Current per Contact	Max. Voltage	Cable Diameter Range	Male Straight		Male Right Angle	
				Engineering No.	Standard Order No.	Engineering No.	Standard Order No.
	4.0A	250V AC 300V DC	3.30-6.60mm (.130-.260")	8A4006-31	120071-0038	8A4007-31	120071-0040
			4.10-8.10mm (.161-.319")	8A4006-32	120071-0039		
	4.0A	30V AC 36V DC	3.30-6.60mm (.130-.260")	8A5006-31	120071-0045	8A5007-31	120071-0049
			4.10-8.10mm (.161-.319")	8A5006-32	120071-0047		

Note: Sales drawings for all standard order numbers are available on molex.com.
Viton® is a registered trademark of E.I. DuPont De Nemours and Company.

Brad® Micro-Change® (M12) A-Code Solid Body Splitter and Tees (US)

120068



Features and Benefits

- Solid body splitters allow you to create a customized wiring scheme, either by combining two 3-conductor cables into a 5-conductor cable or implementing a trunk-and-drop wiring topology
- Splitters permit the connection of two I/O devices to a port on dual-wired distribution boxes
- Parallel wired tees allows for tapping into a cable run or implementing a trunk and drop wiring scheme

Electrical

Voltage: 30V
Amperage: 4.0A

Physical

Connector Body: PUR (PVC for grey or yellow splitters)
Contact Carries: PUR
O-ring: Viton®
Coupling Nut: Nickel-plated Brass
Contacts: Copper alloy with Gold over Nickel plating

Environmental

Protection: IP67
NEMA Rating: NEMA 6

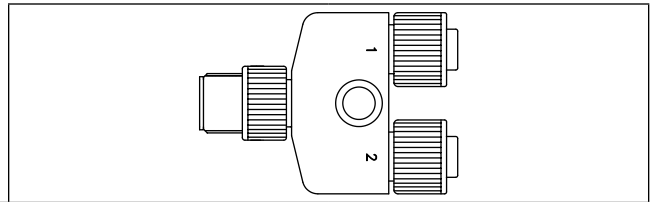

M12 Splitters

Wiring Schematic	Color	Engineering No.	Standard Order No.
<p>Without LEDs</p>	Yellow	81594R	120068-0170
	Grey	81590R	120068-0169
	Black	0812-05EMF-00000	120068-0139
<p>With LEDs</p>	Clear	884AP0	120068-5035

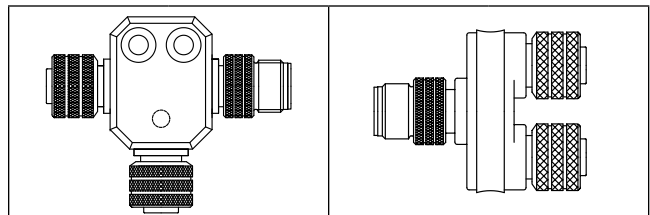

Paralled Wired Tees/Splitters

Wiring Schematic	Color	Engineering No.	Standard Order No.	Engineering No.	Standard Order No.
	Black	0812-051FJ-00000	120068-8009	0812-05EMF-00001	120068-0137

Note: Viton® is a registered trademark of E.I. DuPont De Nemours and Company.

Brad® Micro-Change® (M12) A-Code Splitter Cordsets (US)

120068

Female Straight-to-Male Straight,
Female Right Angle-to-Male
Straight



Features and Benefits

- Features and Benefits
- Splitters permit the connection of two I/O devices to an Ultra-Lock® port on dual-wired distribution boxes
- Push-to-lock technology assures fast, reliable connections every time
- IP67/68 rated for harsh environments
- Reliable performance in high-vibration environments due to positive locking mechanism
- Wide selection of cables to fit applications
 - PVC cables for light, cost-sensitive industrial applications
 - TPE cables for continuous-flex applications. Also ideal for welding cells; cable is weld slag resistant

Reference Information

UL File No.: E152210
CSA File No.: LR6837

Physical

Connector Body: PUR (TPE for K05)
Contact Carries: Polyamide
O-ring: Viton® (EPDM for A09 cables)
Coupling Nut: Nickel-plated Brass (Teflon® coated for K05)
Contacts: Copper alloy with Gold over Nickel plating
Cables: A09—Yellow PVC jacket, 22 AWG PVC conductors, 300V, UL AWM2661
K05—Yellow TPE jacket, 22 AWG PVC conductors, 300V, UL PLTC-ER, +10M flex life (torsion and bending)

Environmental

Protection: IP67
NEMA Rating: NEMA 6

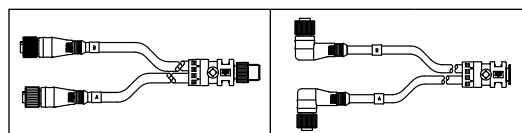

Wiring Schematic	Current per Contact	Max. Voltage	Cable Type	Cable Jacket (Cable Code)	Wire Size AWG	Length	Female Straight-to-Male Straight		Female Right Angle-to-Male Straight	
							Engineering No.	Order No.	Engineering No.	Order No.
	4.0A	250V AC/DC	UL 2661	PVC (A09)	22	0.3m	884A30A09M003	120068-0175	884A31A09M003	120068-0199
			PLTC-ER	TPE (K05)			884A30K05M003	120068-0195	884A31K05M003	120068-0211

Note: Sales drawings for all standard order numbers are available on molex.com.
Teflon® and Viton® are registered trademarks of E.I. DuPont De Nemours and Company.

Configuration Code†
Build-a-Part Number

Meters	Length	Code
	0.3	M003
0.6	M006	
1.0	M010	
3.0	M030	
5.0	M050	

Coupling Nut Option
Stainless Steel 8

884A30A09M0038

†Once an engineering number is created using the configuration code, consult Molex tech support for information regarding any part numbers.

Brad® Micro-Change® (M12) Distribution Boxes (US)

120114

Top Mount, Single Wired Ports With Brad® Mini-Change® HR Connector



Features and Benefits

- Fully potted, factory assembled boxes simplify on machine wiring installations
- One input/output per port
- Indicating LEDs for power and sensor trigger indication
- Versions available for use with PNP and NPN sensors
- Mini-change home run connector for easy replacement

Reference Information

UL File No.: E152210
CSA File No.: LR6837

Electrical

Voltage: 10-30V DC max.
Amperage: Module—12.0A max.
Port—4.0A max.

Physical

Housing: PBT
Port Shell Material: Nickel-plated Brass
Contacts: Copper alloy with Gold over Nickel plating
Home Run Connector: Mini-Change 12-pole male connector
Wiring Configuration: Single I/O, M12 4-pole female port

Environmental

Protection: IP67
NEMA Rating: NEMA 6

Port Configuration	Box Configuration	Ports	LED Indicator	For Sensor	Engineering No.	Standard Order No.
		4	No		BTY4010-FBB	120114-0027
		8			BTY8010-FBB	120114-0079
		4	Yes	NPN	BTY401N-FBB	120114-0014
		8			BTY801N-FBB	120114-0059
		4	Yes	PNP	BTY401P-FBB	120114-0019
		6			BTY601P-FBB	120114-0055
		8			BTY801P-FBB	120114-0065

Note: Sales drawings for all standard order numbers are available on molex.com

Suggested Home Run Cable Assemblies

Brad® Mini-Change® 12-pole Female Cordsets

Use With	Cable Jacket	No. of Conductors	Cable Construction	Length	Engineering No.	Standard Order No.
4-port block	PUR	7	4 x 0.34mm ² + 3 x 0.75mm ²	10.0m	302301P80M100	130008-8009
6-port block		9	6 x 0.34mm ² + 3 x 0.75mm ²		302201P80M100	130008-8006
8-port block		11	8 x 0.34mm ² + 3 x 0.75mm ²		302101P80M100	130008-0476

Note: Sales drawings for all standard order numbers are available on molex.com

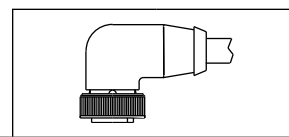

Configuration Code*
Build-a-Part Number

	Length	Code
Meters	5	050
	10	100
	15	150

302101P80M100

*Once an engineering number is created using the configuration code, consult Molex tech support for information regarding any part numbers.

Brad® Micro-Change® (M12) Distribution Boxes (US)

120055/120114

Top Mount, Single Wired Ports With M23 HR Connector



Features and Benefits

- Fully potted, factory assembled boxes simplify on machine wiring installations
- One input/output per port
- Indicating LEDs for power and sensor trigger indication
- Versions available for use with PNP and NPN sensors
- M23 home run connector for easy replacement

Reference Information

UL File No.: E152210
CSA File No.: LR6837

Electrical

Voltage: 10-30V DC max.
Amperage: Module—12.0A max.
Port—4.0A max.

Physical

Housing: PBT
Port Shell Material: Nickel-plated Brass
Contacts: Copper alloy with Gold over Nickel plating
Home Run Connector: M23 12-pole male connector
Wiring Configuration: Single I/O, M12 4-pole female port

Environmental

Protection: IP67
NEMA Rating: NEMA 6

Port Configuration	Box Configuration	Ports	LED Indicator	For Sensor	Engineering No.	Standard Order No.
		4	No		BTY4010-FBC	120055-0308
		8			BTY8010-FBC	120055-0321
		4	Yes	NPN	BTY401N-FBC	120114-0211
		8			BTY801N-FBC	120114-0060
		4	Yes	PNP	BTY401P-FBC	120114-0020
		8			BTY801P-FBC	120114-0066

Note: Sales drawings for all standard order numbers are available on molex.com

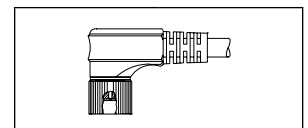

Suggested Home Run Cable Assemblies

M23 12-pole Female Cordsets and Field Attachable Connector

Use With	Cable Jacket	No. of Conductors	Cable Construction	Length	Engineering No.	Standard Order No.
4-part block	PUR	7	4 x 0.34mm ² + 3 x 0.75mm ²	10.0m	K02301P80M100	120094-5023
6-part block		9	6 x 0.34mm ² + 3 x 0.75mm ²		K02201P80M100	120094-8013
8-part block		11	8 x 0.34mm ² + 3 x 0.75mm ²		K02101P80M100	120094-0125
All		M23 12-pole Female Field Attachable Kit			KASCS00-025	120230-0032

Note: Sales drawings for all standard order numbers are available on molex.com

Configuration Code*
Build-a-Part Number

	Length	Code
Meters	5	050
	10	100
	15	150

K02101P80M100

*Once an engineering number is created using the configuration code, consult Molex tech support for information regarding any part numbers.

Brad® Micro-Change® (M12) Distribution Boxes (US)

120114

Top Mount, Dual Wired Ports With Brad® Mini-Change® HR Connector



Features and Benefits

- Fully potted, factory assembled boxes simplify on machine wiring installations
- Two input/outputs per port
- Indicating LEDs for power and sensor trigger indication
- Versions available for use with PNP and NPN sensors
- Mini-change home run connector for easy replacement

Reference Information

UL File No.: E152210
CSA File No.: LR6837

Electrical

Voltage: 10-30V DC max.
Amperage: Module—12.0A max.
Port—4.0A max.

Physical

Housing: PBT
Port Shell Material: Nickel-plated Brass
Contacts: Copper alloy with Gold over Nickel plating
Home Run Connector: Mini-Change 19-pole male connector
Wiring Configuration: Dual I/O, M12 5-pole female port

Environmental

Protection: IP67
NEMA Rating: NEMA 6

Port Configuration	Box Configuration	Ports	LED Indicator	For Sensor	Engineering No.	Standard Order No.
		4	No		BTY4030-FBB	120114-0035
		8			BTY8030-FBB	120114-0087
		4	Yes	PNP	BTY403P-FBB	120114-0030
		8			BTY803P-FBB	120114-0083

Note: Sales drawings for all standard order numbers are available on molex.com

Suggested Home Run Cable Assemblies

Brad® Mini-Change® 19-pole Female Cordsets

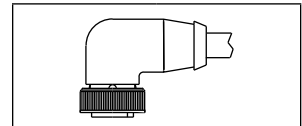

Use With	Cable Jacket	No. of Conductors	Cable Construction	Length	Engineering No.	Standard Order No.
4-port block	PUR	15	12 x 0.34mm ² + 3 x 0.75mm ²	10.0m	303201P80M100	130008-5006
8-port block		19	16 x 0.34mm ² + 3 x 0.75mm ²		303001P80M100	130008-0316

Note: Sales drawings for all standard order numbers are available on molex.com

Configuration Code*

Build-a-Part Number

	Length	Code
Meters	5	050
	10	100
	15	150

303001P80M100

*Once an engineering number is created using the configuration code, consult Molex tech support for information regarding any part numbers.

Brad® Micro-Change® (M12) Distribution Boxes (US)

120055/120114

Top Mount, Dual Wired Ports With M23 HR Connector



Features and Benefits

- Fully potted, factory assembled boxes simplify on machine wiring installations
- Two input/outputs per port
- Indicating LEDs for power and sensor trigger indication
- Versions available for use with PNP and NPN sensors
- M23 home run connector for easy replacement

Reference Information

UL File No.: E152210
CSA File No.: LR6837

Electrical

Voltage: 10-30V DC max.
Amperage: Module—12.0A max.
Port—4.0A max.

Physical

Housing: PBT
Port Shell Material: Nickel-plated Brass
Contacts: Copper alloy with Gold over Nickel plating
Home Run Connector: M23 19-pole male connector
Wiring Configuration: Dual I/O, M12 5-pole female port

Environmental

Protection: IP67
NEMA Rating: NEMA 6

Port Configuration	Box Configuration	Ports	LED Indicator	For Sensor	Engineering No.	Standard Order No.
		4	No		BTY4030-FBC	120055-0313
		8			BTY8030-FBC	120055-0328
		4	Yes	PNP	BTY403P-FBC	120114-0031
		8			BTY803P-FBC	120114-0084

Note: Sales drawings for all standard order numbers are available on molex.com

Suggested Home Run Cable Assemblies

M23 19-pole Female Cordsets

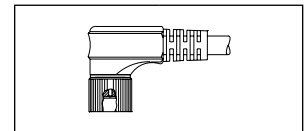

Use With	Cable Jacket	No. of Conductors	Cable Construction	Length	Engineering No.	Standard Order No.
4-part block	PUR	11	8 x 0.34mm ² + 3 x 0.75mm ²	10.0m	K03301P80M100	120094-8045
6-part block		15	12 x 0.34mm ² + 3 x 0.75mm ²		K03201P80M100	120094-8027
8-part block		19	16 x 0.34mm ² + 3 x 0.75mm ²		K03001P80M100	120094-0044

Note: Sales drawings for all standard order numbers are available on molex.com

Configuration Code*

Build-a-Part Number

	Length	Code
Meters	5	050
	10	100
	15	150

K03001P80M100

*Once an engineering number is created using the configuration code, consult Molex tech support for information regarding any part numbers.

Brad® Micro-Change® (M12) Distribution Boxes (US)

120055/120114

Top Mount, Dual Wired Ports With Field Attachable HR Terminal Strip



Features and Benefits

- Fully potted, factory assembled boxes simplify on machine wiring installations
- Two input/outputs per port
- Indicating LEDs for power and sensor trigger indication
- Versions available for use with PNP and NPN sensors
- Home run terminal strip provides greatest flexibility for cable choices and trimming to length on machine

Reference Information

UL File No.: E152210
CSA File No.: LR6837

Electrical

Voltage: 10-30V DC max.
Amperage: Module—12.0A max.
Port—4.0A max.

Physical

Housing: PBT
Port Shell Material: Nickel-plated Brass
Contacts: Copper alloy with Gold over Nickel plating
Home Run Connector: Terminal strip
Wiring Configuration: Dual I/O, M12 5-pole female port

Environmental

Protection: IP67
NEMA Rating: NEMA 6

Port Configuration	Box Configuration	Ports	LED Indicator	For Sensor	Engineering No.	Standard Order No.
		4	No		BTY4030-FBA	120114-0034
		6			BTY6030-FBA	120114-0057
		8			BTY8030-FBA	120114-0086
		4	Yes	NPN	BTY403N-FBA	120055-0669
		6			BTY603N-FBA	120055-0670
		8			BTY803N-FBA	120055-0672
		4	Yes	PNP	BTY403P-FBA	120114-0029
		6			BTY603P-FBA	120114-0056
		8			BTY803P-FBA	120114-0082

Note: Sales drawings for all standard order numbers are available on molex.com

Brad® Micro-Change® (M12) Distribution Boxes (US)

120055/120114

Top Mount, Single Wired Ports With PUR HR Cable



Features and Benefits

- Fully potted, factory assembled boxes simplify on machine wiring installations
- One input/output per port
- Indicating LEDs for power and sensor trigger indication
- Versions available for use with PNP and NPN sensors
- Integral home run cable eliminates need for purchase of additional component for installation

Electrical

Voltage: 10-30V DC max.
 Amperage: Module—12.0A max.
 Port—4.0A max.

Physical

Housing: PBT
 Port Shell Material: Nickel-plated Brass
 Contacts: Copper alloy with Gold over Nickel plating
 Wiring Configuration: Single I/O, M12 4-pole female port
 Home Run Cable: Black PUR cable, conductors:
 4-port—4 x 0.34mm² + 3 x 0.75mm²
 6-port—6 x 0.34mm² + 3 x 0.75mm²
 8-port—8 x 0.34mm² + 3 x 0.75mm²

Environmental

Protection: IP67
 NEMA Rating: NEMA 6

Port Configuration	Box Configuration	Ports	LED Indicator	For Sensor	Length	Engineering No.	Standard Order No.
		4	No		5.0m	BTY4000-FBP-05	120055-0586
		8					
		4	Yes	NPN	5.0m	BTY400N-FBP-05	120114-8008
		8					
		4	Yes	PNP	5.0m	BTY400P-FBP-05	120114-8011
		8					

Note: Sales drawings for all standard order numbers are available on molex.com

Configuration Code*

Build-a-Part Number

	Length	Code
Meters	5	050
	10	100
	15	150

BTY800P-FBP-05

*Once an engineering number is created using the configuration code, consult Molex tech support for information regarding any part numbers.

Brad® Micro-Change® (M12) Distribution Boxes (US)

120114

Top Mount, Dual Wired Ports With PUR HR Cable



Features and Benefits

- Fully potted, factory assembled boxes simplify on machine wiring installations
- Two input/outputs per port
- Indicating LEDs for power and sensor trigger indication
- Versions available for use with PNP and NPN sensors
- Integral home run cable eliminates need for purchase of additional component for installing

Reference Information

UL File No.: E152210
CSA File No.: LR6837

Electrical

Voltage: 10-30V DC max.
Amperage: Module—12.0A max.
Port—4.0A max.

Physical

Housing: PBT
Port Shell Material: Nickel-plated Brass
Contacts: Copper alloy with Gold over Nickel plating
Wiring Configuration: Dual I/O, M12 5-pole female port
Home Run Cable: Black PUR cable, conductors:
4-port—8 x 0.34mm² + 3 x 0.75mm²
6-port—12 x 0.34mm² + 3 x 0.75mm²
8-port—16 x 0.34mm² + 3 x 0.75mm²

Environmental

Protection: IP67
NEMA Rating: NEMA 6

Port Configuration	Box Configuration	Ports	LED Indicator	For Sensor	Length	Engineering No.	Standard Order No.
		4	No		5.0m	BTY4050-FBP-05	120114-0042
		8				BTY8050-FBP-05	120114-0092
		4	Yes	NPN	5.0m	BTY405N-FBP-05	120114-0037
		8				BTY805N-FBP-05	120114-0202
		4	Yes	PNP	5.0m	BTY405P-FBP-05	120114-0039
		8				BTY805P-FBP-05	120114-0089

Note: Sales drawings for all standard order numbers are available on molex.com

Configuration Code*

Build-a-Part Number

	Length	Code
Meters	5	050
	10	100
	15	150

BTY805P-FBP-05

*Once an engineering number is created using the configuration code, consult Molex tech support for information regarding any part numbers.

Brad® Micro-Change® (M12) Distribution Boxes (US)

120114

Top Mount, Dual Wired Ports with Molded Brad® Mini-Change® HR Cordset



Features and Benefits

- Fully potted, factory assembled boxes simplify on machine wiring installations
- Single input/output per port
- Indicating LEDs for power and sensor trigger indication
- Versions available for use with PNP and NPN sensors
- Integral home run cordset with Mini-change 19-pole male connector provides easy replacement

Reference Information

UL File No.: E152210
CSA File No.: LR6837

Electrical

Voltage: 10-30V DC max.
Amperage: Module—12.0A max.
Port—4.0A max.

Physical

Housing: PBT
Port Shell Material: Nickel-plated Brass
Contacts: Copper alloy with Gold over Nickel plating
Wiring Configuration: Dual I/O, M12 5-pole female port
Home Run Cable: Black PUR cable, conductors:
4-port—8 x 0.34mm² + 3 x 0.75mm²
6-port—12 x 0.34mm² + 3 x 0.75mm²
8-port—16 x 0.34mm² + 3 x 0.75mm²

Environmental

Protection: IP67
NEMA Rating: NEMA 6

Port Configuration	Box Configuration	Ports	LED Indicator	For Sensor	Length	Engineering No.	Standard Order No.
		4	No		5.0m	BTY4120-FBP-05	120114-0048
		8				BTY8120-FBP-050	120114-0099
		4	Yes	NPN	5.0m	BTY412N-FBP-05	120114-0192
		8				BTY812N-FBP-05	120114-0095
		4	Yes	PNP	5.0m	BTY412P-FBP-05	120114-0045
		8				BTY812P-FBP-05	120114-0097

Note: Sales drawings for all standard order numbers are available on molex.com

Configuration Code*

Build-a-Part Number

	Length	Code
Meters	5	050
	10	100
	15	150

BTY812P-FBP-05

*Once an engineering number is created using the configuration code, consult Molex tech support for information regarding any part numbers.

Brad® Micro-Change® Dual Key (1/2"-20 UNF) Single-Ended Cordsets (US)

120072

**Female, Pigtail
Straight, Right Angle**



Features and Benefits

- Dual-Key connectors with 1/2-20 UNF threaded couplers
- Traditionally used with AC powered sensors
- IP67/68 rated for harsh environments
- Patented anti-vibration feature to prevent loosening under high-vibration applications
- Wide selection of cables to fit applications:
 - Oil resistant PVC with metallic braid for added mechanical robustness
 - Oil resistant PVC with 18 AWG conductors

Reference Information

UL File No.: E152210
CSA File No.: LR6837

Physical

Connector Body: PVC
Contact Carries: Nylon
O-ring: Viton®
Coupling Nut : Zinc diecast, black epoxy coated,
1/2-20 UNF thread
Contacts: Copper alloy with Gold over Nickel plating
Cables: D02—Yellow PVC jacket with 70% metallic braid
and 22 AWG PVC conductors, 300V,
UL AWM2661
A03—Yellow PVC jacket and 18 AWG PVC
conductors, 300V, UL AWM2661
Operating Temperature: -20 to +105° C

Environmental

Protection: IP67
NEMA Rating: NEMA 6

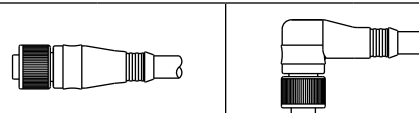

Poles (Female View)	Max. Current per Contact	Max. Voltage	Cable Type	Cable Jacket (Cable Code)	Wire Size AWG	Length	Female Straight		Female Right Angle	
							Engineering No.	Standard Order No.	Engineering No.	Standard Order No.
2 Pole 1 - Brown 2 - Blue	4.0A	250V AC/DC	UL 2661	PVC (D02)	22	6'	702000D02F060	120072-0061	702001D02F060	120072-0085
3 Pole 1 - Green gnd 3 - Red-white 2 - Red-black	4.0A	250V AC/DC	UL 2464	PVC (A03)	18	6'	703000A03F060	120072-0130	703001A03F060	120072-0219
			UL 2661	PVC (D02)	22		703000D02F060	120072-0171	703001D02F060	120072-0250
4 Pole 1 - Red-black 3 - Red 2 - Red-white 4 - Green gnd	4.0A	250V AC/DC	UL 2464	PVC (A03)	18	6'	704000A03F060	120072-0334	704001A03F060	120072-0387
			UL 2661	PVC (D02)	22		704000D02F060	120072-0356	704001D02F060	120072-0402
5 Pole 1 - Red-white 4 - Red-yellow 2 - Red 5 - Red-black 3 - Green gnd	4.0A	250V AC/DC	UL 2464	PVC (A03)	18	6'	705000A03F060	120072-0459	705001A03F060	120072-0508
			UL 2661	PVC (D02)	22		705000D02F060	120072-0471	705001D02F060	120072-0515
6 Pole 1 - Red-white 4 - Red-yellow 2 - Red 5 - Red-black 3 - Green gnd 6 - Red-blue	4.0A	250V AC/DC	UL 2661	PVC (D02)	22	6'	706000D02F060	120072-0568	706001D02F060	120072-0595

Note: Sales drawings for all standard order numbers are available on molex.com

Configuration Code*
Build-a-Part Number

Length	Code
3	F030
6	F060
12	F120
20	F200

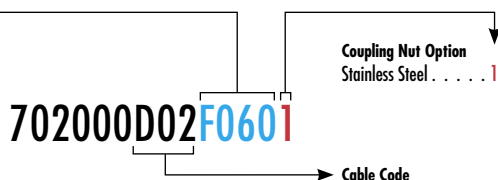

*Once an engineering number is created using the configuration code, consult Molex tech support for information regarding any part numbers.

Brad® Micro-Change® Dual Key (1/2"-20 UNF) Single-Ended Cordsets (US)

120072
Male, Pigtail
Straight, Right Angle



Features and Benefits

- Dual-Key connectors with 1/2-20 UNF threaded couplers
- Traditionally used with AC powered sensors
- IP67/68 rated for harsh environments
- Patented anti-vibration feature to prevent loosening under high-vibration applications
- Wide selection of cables to fit applications:
 - Oil resistant PVC with metallic braid for added mechanical robustness
 - Oil resistant PVC with 18 AWG conductors

Reference Information

UL File No.: E152210
CSA File No.: LR6837

Physical

Connector Body: PVC
Contact Carries: Nylon
O-ring: Viton®
Coupling Nut : Zinc diecast, black epoxy coated,
1/2-20 UNF thread
Contacts: Copper alloy with Gold over Nickel plating
Cables: D02—Yellow PVC jacket with 70% metallic braid
and 22 AWG PVC conductors, 300V,
UL AWM2661
A03—Yellow PVC jacket and 18 AWG PVC
conductors, 300V, UL AWM2661
Operating Temperature: -20 to +105° C

Environmental

Protection: IP67
NEMA Rating: NEMA 6

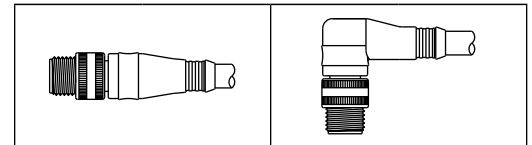

Poles (Male View)	Max. Current per Contact	Max. Voltage	Cable Type	Cable Jacket (Cable Code)	Wire Size AWG	Length	Male Straight		Male Right Angle	
							Engineering No.	Standard Order No.	Engineering No.	Standard Order No.
2 Pole 1 - Brown 2 - Blue	4.0A	250V AC/DC	UL 2661	PVC (D02)	22	6'	702006D02F060	120072-0108	702007D02F060	120072-0118
3 Pole 1 - Green gnd 3 - Red-white 2 - Red-black	4.0A	250V AC/DC	UL 2464	PVC (A03)	18	6'	703006A03F060	120072-0292	703007A03F060	120072-0315
			UL 2661	PVC (D02)	22		703006D02F060	120072-0302	703007D02F060	120072-0318
4 Pole 1 - Red-black 3 - Red 2 - Red-white 4 - Green gnd	4.0A	250V AC/DC	UL 2464	PVC (A03)	18	6'	704006A03F060	120072-0435	704007A03F060	120072-5019
			UL 2661	PVC (D02)	22		704006D02F060	120072-0445	704007D02F060	120072-1022
5 Pole 1 - Red-white 4 - Red-yellow 2 - Red 5 - Red-black 3 - Green gnd	4.0A	250V AC/DC	UL 2464	PVC (A03)	18	6'	705006A03F060	120072-0546	705007A03F060	120072-1010
			UL 2661	PVC (D02)	22		705006D02F060	120072-0551	705007D02F060	120072-0558
6 Pole 1 - Red-white 4 - Red-yellow 2 - Red 5 - Red-black 3 - Green gnd 6 - Red-blue	4.0A	250V AC/DC	UL 2661	PVC (D02)	22	6'	706006D02F060	120072-0616	706007D02F060	120072-0626

Note: Sales drawings for all standard order numbers are available on molex.com

Configuration Code*
Build-a-Part Number

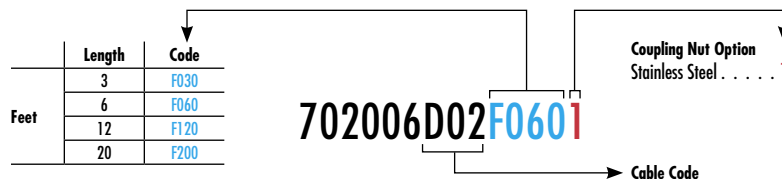

*Once an engineering number is created using the configuration code, consult Molex tech support for information regarding any part numbers.

Brad® Micro-Change® Dual Key (1/2"-20 UNF) Double-Ended Cordsets (US)

120073

**Female Straight-to-Male Straight,
Female Right Angle-to-Male
Straight**



Features and Benefits

- Dual-Key connectors with 1/2-20 UNF threaded couplers
- Traditionally used with AC powered sensors
- IP67/68 rated for harsh environments
- Patented anti-vibration feature to prevent loosening under high-vibration applications
- Wide selection of cables to fit applications:
 - Oil resistant PVC with metallic braid for added mechanical robustness
 - Oil resistant PVC with 18 AWG conductors

Reference Information

UL File No.: E152210
CSA File No.: LR6837

Physical

Connector Body: PVC
Contact Carries: Nylon
O-ring: Viton®
Coupling Nut : Zinc diecast, black epoxy coated,
1/2-20 UNF thread
Contacts: Copper alloy with Gold over Nickel plating
Cables: D02—Yellow PVC jacket with 70% metallic braid
and 22 AWG PVC conductors, 300V,
UL AWM2661
A03—Yellow PVC jacket and 18 AWG PVC
conductors, 300V, UL AWM2661
Operating Temperature: -20 to +105° C

Environmental

Protection: IP67
NEMA Rating: NEMA 6

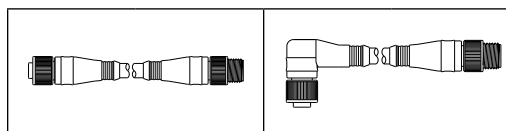

Poles (Female View)	Max. Current per Contact	Max. Voltage	Cable Type	Cable Jacket (Cable Code)	Wire Size AWG	Length	Female Straight-to-Male Straight		Female Right Angle-to-Male Straight	
							Engineering No.	Standard Order No.	Engineering No.	Standard Order No.
2 Pole 1 - Brown 2 - Blue	4.0A	250V AC/DC	UL 2661	PVC (D02)	22	3'	772030D02F030	120073-0057	772031D02F030	120073-5009
3 Pole 1 - Green gnd 3 - Red-white 2 - Red-black	4.0A	250V AC/DC	UL 2464	PVC (A03)	18	3'	773030A03F030	120073-0085	773031A03F030	120073-0140
			UL 2661	PVC (D02)	22		773030D02F030	120073-0100	773031D02F030	120073-0151
4 Pole 1 - Red-black 3 - Red 2 - Red-white 4 - Green gnd	4.0A	250V AC/DC	UL 2464	PVC (A03)	18	3'	774030A03F030	120073-0391	774031A03F030	120073-0237
			UL 2661	PVC (D02)	22		774030D02F030	120073-0215	774031D02F030	120073-0241
5 Pole 1 - Red-white 4 - Red-yellow 2 - Red 5 - Red-black 3 - Green gnd	4.0A	250V AC/DC	UL 2464	PVC (A03)	18	3'	775030A03F030	120073-0272	775031A03F030	120073-5012
			UL 2661	PVC (D02)	22		775030D02F030	120073-0293	775031D02F030	120073-0335
6 Pole 1 - Red-white 4 - Red-yellow 2 - Red 5 - Red-black 3 - Green gnd 6 - Red-blue	4.0A	250V AC/DC	UL 2661	PVC (D02)	22	3'	776030D02F030	120073-0357	776031D02F030	120073-0376

Note: Sales drawings for all standard order numbers are available on molex.com

Configuration Code*
Build-a-Part Number

Length	Code
3	F030
6	F060
12	F120
20	F200

772030D02F0301

Coupling Nut Option
Stainless Steel 1

Cable Code

*Once an engineering number is created using the configuration code, consult Molex tech support for information regarding any part numbers.

Brad® Micro-Change® Dual Key (1/2"-20 UNF) Double-Ended Cordsets (US)

120073

Female Straight-to-Male Right Angle, Female Right Angle-to-Male Right Angle



Features and Benefits

- Dual-Key connectors with 1/2-20 UNF threaded couplers
- Traditionally used with AC powered sensors
- IP67/68 rated for harsh environments
- Patented anti-vibration feature to prevent loosening under high-vibration applications
- Wide selection of cables to fit applications:
 - Oil resistant PVC with metallic braid for added mechanical robustness
 - Oil resistant PVC with 18 AWG conductors

Reference Information

UL File No.: E152210

CSA File No.: LR6837

Physical

Connector Body: PVC

Contact Carries: Nylon

O-ring: Viton®

Coupling Nut : Zinc diecast, black epoxy coated, 1/2-20 UNF thread

Contacts: Copper alloy with Gold over Nickel plating

Cables: D02—Yellow PVC jacket with 70% metallic braid and 22 AWG PVC conductors, 300V, UL AWM2661

A03—Yellow PVC jacket and 18 AWG PVC conductors, 300V, UL AWM2661

Operating Temperature: -20 to +105° C

Environmental

Protection: IP67

NEMA Rating: NEMA 6

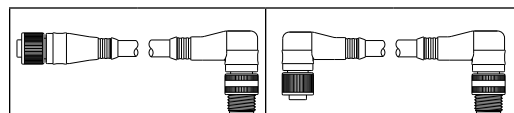

Poles (Female View)	Max. Current per Contact	Max. Voltage	Cable Type	Cable Jacket (Cable Code)	Wire Size AWG	Length	Female Straight-to-Male Right Angle		Female Right Angle-to-Male Right Angle	
							Engineering No.	Standard Order No.	Engineering No.	Standard Order No.
 2 Pole 1 - Brown 2 - Blue	4.0A	250V AC/DC	UL 2661	PVC (D02)	22	3'	772032D02F030	120073-5010	772033D02F030	120073-0068
 3 Pole 1 - Green gnd 2 - Red-black 3 - Red-white	4.0A	250V AC/DC	UL 2464	PVC (A03)	18	3'	773032A03F030	120073-0172	773033A03F030	120073-0185
			UL 2661	PVC (D02)	22		773032D02F030	120073-0178	773033D02F030	120073-0190
 4 Pole 1 - Red-black 2 - Red-white 3 - Red 4 - Green gnd	4.0A	250V AC/DC	UL 2464	PVC (A03)	18	3'	774032A03F030	120073-0246	774033A03F030	120073-0390
			UL 2661	PVC (D02)	22		774032D02F030	120073-0250	774033D02F030	120073-5011
 5 Pole 1 - Red-white 2 - Red 3 - Green gnd 4 - Red-yellow 5 - Red-black	4.0A	250V AC/DC	UL 2464	PVC (A03)	18	3'	775032A03F030	120073-0346	775033A03F030	120073-0351
			UL 2661	PVC (D02)	22		775032D02F030	120073-5013	775033D02F030	120073-0354
 6 Pole 1 - Red-white 2 - Red 3 - Green gnd 4 - Red-yellow 5 - Red-black 6 - Red-blue	4.0A	250V AC/DC	UL 2661	PVC (D02)	22	3'	776032D02F030	120073-0577	776033D02F030	120073-5014

Note: Sales drawings for all standard order numbers are available on molex.com

Configuration Code*
Build-a-Part Number

Length	Code
3	F030
6	F060
12	F120
20	F200

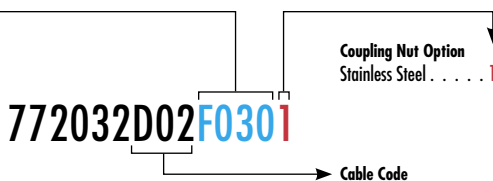

*Once an engineering number is created using the configuration code, consult Molex tech support for information regarding any part numbers.

Brad® Micro-Change® Dual Key (1/2"-20 UNF) Receptacles (US)

120074

**Female
Front Panel Mount**



Features and Benefits

- Dual-Key receptacles with 1/2"-20 UNF threaded couplers
- Available in 2 to 5-pole configurations
- Fully potted assemblies provide IP67/68 protection for harsh environments
- Receptacles with wired leads to be used in control panels, junction boxes and sensors. Other configurations also available.

Reference Information

UL File No.: E152210
CSA File No.: LR6837

Physical

Shell Material: Anodized Alum
Contact Carriers: Nylon 6/6
O-Ring: M12—Red Viton®
Panel—Black Viton
Contacts: Copper alloy with Gold over Nickel plating
Wire PVC insulation: 300V, 80C, UL1061, 22 AWG

Environmental

Protection: IP67
NEMA Rating: NEMA 6

Configuration	1/4-18NPT, Front Panel Mount
Wire Type	PVC leads, UL1061
Wire Size	22 AWG
Length	12"

Poles	Max. Current per Contact	Max. Voltage	Engineering No.	Standard Order No.
<p>2 Pole</p> <p>1 - Brown 2 - Blue</p>	4.0A	250V AC/DC	7R2A00A19A120	120074-0014
<p>3 Pole</p> <p>1 - Green gnd 3 - Red-white 2 - Red-black</p>	4.0A	250V AC/DC	7R3A00A19A120	120074-0058
<p>4 Pole</p> <p>1 - Red-black 3 - Red 2 - Red-white 4 - Green gnd</p>	4.0A	250V AC/DC	7R4A00A19A120	120074-0122
<p>5 Pole</p> <p>1 - Red-white 4 - Red-yellow 2 - Red 5 - Red-black 3 - Green gnd</p>	4.0A	250V AC/DC	7R5A00A19A120	120074-0178

Note: Sales drawings for all standard order numbers are available on molex.com.
Viton® is a registered trademark of E.I. DuPont De Nemours and Company.

Configuration Code*
Build-a-Part Number

	Length	Code
Feet	1.0	A120
	3.0	F030

7R2A00A19A120

→ Wire Type
→ Configuration

*Once an engineering number is created using the configuration code, consult Molex tech support for information regarding any part numbers.

Brad® Micro-Change® Dual Key (1/2"-20 UNF) Receptacles (US)

120074

**Male
Front Panel Mount**



Features and Benefits

- Dual-Key receptacles with 1/2"-20 UNF threaded couplers
- Available in 2- to 5-pole configurations
- Fully potted assemblies provide IP67/68 protection for harsh environments
- Receptacles with wired leads to be used in control panels, junction boxes and sensors. Other configurations also available.

Reference Information

UL File No.: E152210
CSA File No.: LR6837

Physical

Shell Material: Anodized Aluminum
Contact Carries: Nylon 6/6
O-Ring: Panel—Black Viton®
Contacts: Copper alloy with Gold over Nickel plating
Wire PVC insulation: 300V, 80C, UL1061, 22 AWG

Environmental

Protection: IP67
NEMA Rating: NEMA 6

Configuration Wire Type Wire Size Length		
	1/2-14NPT, Front Panel Mount	1/4-18NPT, Front Panel Mount
	PVC leads, UL1061	PVC leads, UL1061
	22 AWG	22 AWG
	12"	12"

Poles	Max. Current per Contact	Max. Voltage	Engineering No.	Standard Order No.	Engineering No.	Standard Order No.
2 Pole 1 - Brown 2 - Blue	4.0A	250V AC/DC	7R2006A19A120	120074-0042	7R2A06A19A120	120074-0030
3 Pole 1 - Green gnd 3 - Red-white 2 - Red-black	4.0A	250V AC/DC	7R3006A19A120	120074-0106	7R3A06A19A120	120074-0079
4 Pole 1 - Red-black 3 - Red 2 - Red-white 4 - Green gnd	4.0A	250V AC/DC	7R4006A19A120	120074-0160	7R4A06A19A120	120074-0140
5 Pole 1 - Red-white 4 - Red-yellow 2 - Red 5 - Red-black 3 - Green gnd	4.0A	250V AC/DC	7R5006A19A120	120074-0222	7R5A06A19A120	120074-0190

Note: Sales drawings for all standard order numbers are available on molex.com.
Viton® is a registered trademark of E.I. DuPont De Nemours and Company.

Configuration Code*
Build-a-Part Number

	Length	Code
Feet	1.0	A120
	3.0	F030

7R2006A19A120

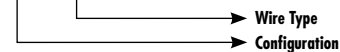

*Once an engineering number is created using the configuration code, consult Molex tech support for information regarding any part numbers.

Brad® Micro-Change® Dual Key (1/2"-20 UNF) Field Attachable Connectors (US)

120075

**Female, Male
Straight, Right Angle**



Features and Benefits

- Allows field termination of cables to 1/2-20 UNF—Dual Key Connector
- Preassembled contact carries with screw terminals provides easy field termination of conductors
- Back end housing and cable gland provides IP67 protection and strain relief

Physical

Connector Body: PA
 Contact Carries: PA
 O-ring: Viton®
 Coupling Nut: Nickel-plated Brass
 Contacts: Copper alloy with Gold over Nickel plating
 Termination: Screw down terminals, accepts conductors up to 18 AWG (0.75mm²)

Environmental

Protection: IP67
 NEMA Rating: NEMA 6

Female Connectors

Poles	Current per Contact	Max. Voltage	Cable Diameter Range	Female Straight		Female Right Angle	
				Engineering No.	Standard Order No.	Engineering No.	Standard Order No.
	4.0A	250V AC 300V DC	3.30-6.60mm (.130-.260")	7A3000-31	120075-0014	7A3001-31	120075-0016
	4.0A	250V AC 300V DC	4.10-8.10mm (.161-.319")	7A3000-32	120075-0015		

Male Connectors

Poles	Current per Contact	Max. Voltage	Cable Diameter Range	Male Straight		Male Right Angle	
				Engineering No.	Standard Order No.	Engineering No.	Standard Order No.
	4.0A	250V AC 300V DC	3.30-6.60mm (.130-.260")	7A3006-31	120075-0017	7A3007-31	120075-0019
	4.0A	250V AC 300V DC	4.10-8.10mm (.161-.319")	7A3006-32	120075-0018		

Note: Sales drawings for all standard order numbers are available on molex.com.
 Viton® is a registered trademark of E.I. DuPont De Nemours and Company.

Brad® Nano-Change® (M8) Connectors

Nano

UNITED STATES (also includes Canada, Mexico and South America)

Brad® Nano-Change® (M8) compact connectors and cordsets from Molex are part of a broad selection of rugged, space-saving cordsets, receptacles, inserts, splitters and molded junction boxes.

Nano-Change connectors meet IEC 61076-2-104 standards and are built "industrial tough" to ensure flexibility, interoperability and rugged performance in tight spaces while minimizing downtime, maintenance and wiring time.

Molex Nano-Change offerings include 3-, 4- and 5-pin designs. The cordsets are available with threaded and snap coupling options. A wide array of cable types provides flexibility to accommodate multiple applications.

The molded junction boxes feature a compact, space-saving design that allows simplification of control wiring systems, providing the opportunity for machine builders to design more modular devices. The Nano-Change cable system provides a way to reduce cable bundling expenses by reducing field install cabinets and field wire terminations.

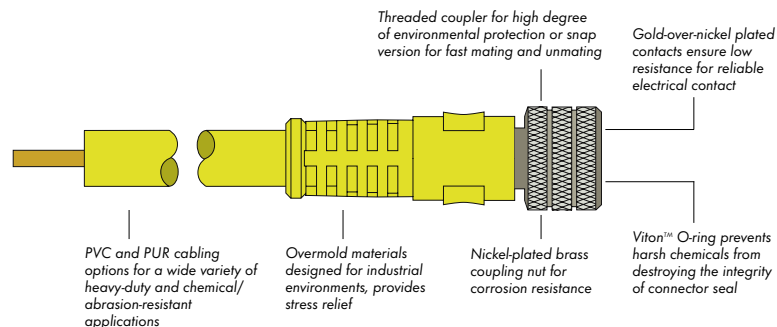

Features and Benefits

Cordsets

- Available with snap or threaded coupler; single- and double-ended cordsets; 3-, 4- and 5-pole configurations; straight and 90°; with and without LED to give users a wide variety of options to meet their requirements
- Compliant with IEC 61076-2-104, allowing intermating with industry-standard M8 devices
- IP67 (threaded) and IP65 (snap)-rated connector interfaces provide rugged, watertight connectors that are suited for harsh, wet environments
- Patented anti-vibration feature prevents backout in high-vibration and mechanical shock applications
- Gold-over-nickel-plated contacts feature a durable, corrosion-resistant plating that maintains low electrical resistance through the mate/unmate cycles

Receptacles, Field Attachables and Accessories

- Wide array of configurations, including front and back panel mount; with leads or PCB pins, give users a wide variety of options to meet their requirements
- Epoxy-potted, IP67-rated receptacles are ideal for rugged industrial environments

- Field attachable connectors with solder cup terminals allow users to customize their application

Distribution Boxes

- Available in 4-, 6-, 8- and 10-port distribution boxes. Single and dual I/O versions with vertical or horizontal mounting available, giving users a wide variety of options to meet application requirements.
- Fully potted housing ensures performance in vibration and fluid environments by providing rugged IP67 (IP68 cabled) rating
- Rugged, compact design allows placement in tight places anywhere on the machine

Applications

- 8.00mm proximity switches
- Miniature photo eyes
- Reed and Hall effect switches
- Other miniature I/O devices and sensors
- Robotic end-of-arm tooling
- Specialty sensors semiconductor assembly equipment

Viton® is a registered trademark of E.I. DuPont De Nemours and Company.

Brad® Nano-Change® (M8) Single-Ended Cordsets (US)

120086

Female, Pigtails
Straight, Right Angle
Threaded



Features and Benefits

- IEC compliant M8 cordset assemblies with threaded couplers
- Small, compact design for miniature sensors and space sensitive applications
- Available in 3-, 4-, and 5-pole versions
- Patented anti-vibration feature to prevent loosening under high-vibration applications
- IP67 rated for harsh environments
- LED version provide power and signal trigger indication for PNP sensors (NPN versions available upon request)
- Wide selection of cables to fit applications:
 - PVC cables for light, cost-sensitive industrial applications
 - PUR cables for moderate flexing and for environments encountering cutting fluids and oils
 - Other types available upon request

Physical

Connector Body: TPE (PVC for LED version)
 Contact Carries: PBT
 O-ring: Viton®
 Coupling Nut: Nickel-plated Brass
 Contacts: Copper alloy with Gold over Nickel plating
 Cables: A10—Yellow PVC jacket, 24 AWG PVC conductors, 300V, UL AWM2661
 B09—Black PUR jacket, 24 AWG PVC conductors, 300V, 80° C, UL AWM 20549 (3 conductor) / AWM 21198 (5 conductor)

Environmental

Protection: IP67
 NEMA Rating: NEMA 6

Reference Information

UL File No.: E152210

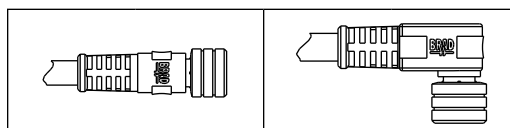

Cordset without Indicating LEDs

Poles	Current per Contact	Max. Voltage	Cable Type	Cable Jacket (Cable Code)	Wire Size	Length	Female Straight		Female Right Angle	
							Engineering No.	Standard Order No.	Engineering No.	Standard Order No.
3 Pole 1 - Brown 4 - Black 3 - Blue	4.0A	60V AC / 75V DC	UL 2661	PVC (A10)	24 AWG	2.0m	403000A10M020	120086-0102	403001A10M020	120086-0119
			UL 20549	PUR (B09)			403000B09M020	120086-0336	403001B09M020	120086-0022
4 Pole 1 - Brown 3 - Blue 2 - White 4 - Black	4.0A	60V AC / 75V DC	UL 2661	PVC (A10)	24 AWG	2.0m	404000A10M020	120086-0144	404001A10M020	120086-0175
				PUR (B09)			404000B09M020	120086-0171	404001B09M020	120086-0042
5 Pole 1 - Brown 4 - Black 2 - White 5 - Gray 3 - Blue	3.0A	60V AC / 75V DC	UL 2661	PVC (A10)	24 AWG	2.0m	405000A10M020	120086-0191	405001A10M020	120086-0200
			UL 21198	PUR (B09)			405000B09M020	120086-0196	405001B09M020	120086-0386

Cordset with Indicating LEDs

Poles	Current per Contact	Max. Voltage	Cable Type	Cable Jacket (Cable Code)	Wire Size	Length	Female Right Angle	
							Engineering No.	Standard Order No.
3 Pole with 1 LED 1 - Brown 4 - Black 3 - Blue	4.0A	30V AC/DC	UL 2661	PVC (A10)	24 AWG	2.0m	4030P1A10M020	120086-0421
			UL 20549	PUR (B09)			4030P1B09M020	120086-0009

Note: Sales drawings for all standard order numbers are available on molex.com.
 Viton® is a registered trademark of E.I. DuPont De Nemours and Company.

Configuration Code*
 Build-a-Part Number

	Length	Code
Meters	2	M020
	5	M050
	10	M100

403000A10M020

Cable Code

*Once an engineering number is created using the configuration code, consult Molex tech support for information regarding any part numbers.

Brad® Nano-Change® (M8) Single-Ended Cordsets (US)

120086

**Male, Pigtails
Straight, Right Angle
Threaded**



Features and Benefits

- IEC compliant M8 cordset assemblies with threaded couplers
- Small, compact design for miniature sensors and space sensitive applications
- Available in 3-, 4-, and 5-pole versions
- Patented anti-vibration feature to prevent loosening under high-vibration applications
- IP67 rated for harsh environments
- Wide selection of cables to fit applications:
 - PVC cables for light, cost-sensitive industrial applications
 - PUR cables for moderate flexing and for environments encountering cutting fluids and oils
 - Other types available upon request

Physical

Connector Body: TPE
 Contact Carries: PBT
 O-ring: Viton®
 Coupling Nut: Nickel-plated Brass
 Contacts: Copper alloy with Gold over Nickel plating
 Cables: A10—Yellow PVC jacket, 24 AWG PVC conductors, 300V, UL AWM2661
 B09—Black PUR jacket, 24AWG PVC conductors, 300V, 80° C, UL AWM 20549 (3 conductor)/AWM 21198 (5 conductor)

Environmental

Protection: IP67
 NEMA Rating: NEMA 6

Reference Information

UL File No.: E152210

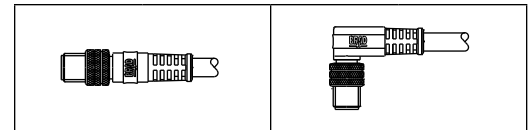

Poles	Current per Contact	Max. Voltage	Cable Type	Cable Jacket (Cable Code)	Wire Size	Length	Male Straight		Male Right Angle	
							Engineering No.	Standard Order No.	Engineering No.	Standard Order No.
3 Pole 1 - Brown 4 - Black 3 - Blue	4.0A	60V AC / 75V DC	UL 2661	PVC (A10)	24 AWG	2.0m	403006A10M020	120086-0132	403007A10M020	120086-0139
			UL 20549	PUR (B09)			403006B09M020	120086-0027	403007B09M020	120086-0033
4 Pole 1 - Brown 3 - Blue 2 - White 4 - Black	4.0A	60V AC / 75V DC	UL 2661	PVC (A10)	24 AWG	2.0m	404006A10M020	120086-0183	404007A10M020	120086-0186
				PUR (B09)			404006B09M020	120086-0048	404007B09M020	120086-0052
5 Pole 1 - Brown 4 - Black 2 - White 5 - Gray 3 - Blue	3.0A	60V AC / 75V DC	UL 2661	PVC (A10)	24 AWG	2.0m	405006A10M020	120086-0206	405007A10M020	120086-0210
			UL 21198	PUR (B09)			405006B09M020	120086-0387	405007B09M020	120086-0390

Note: Sales drawings for all standard order numbers are available on molex.com.
 Viton® is a registered trademark of E.I. DuPont De Nemours and Company.

Configuration Code*
 Build-a-Part Number



*Once an engineering number is created using the configuration code, consult Molex tech support for information regarding any part numbers.

Brad® Nano-Change® (M8) Double-Ended Cordsets (US)

120087

Female Straight-to-Male Straight,
Female Right Angle-to-
Male Straight,
Female Straight-to-Male
Right Angle,
Female Right Angle-to-Male
Right Angle
Threaded



Features and Benefits

- IEC compliant M8 cordset assemblies with threaded couplers
- Small, compact design for miniature sensors and space sensitive applications
- Available in 3-, 4-, and 5-pole versions
- Patented anti-vibration feature to prevent loosening under high-vibration applications
- IP67 rated for harsh environments
- Wide selection of cables to fit applications:
 - PVC cables for light, cost-sensitive industrial applications
 - PUR cables for moderate flexing and for environments encountering cutting fluids and oils
 - Other types available upon request

Reference Information

UL File No.: E152210

Physical

Connector Body: TPE
Contact Carries: PBT
O-ring: Viton®
Coupling Nut: Nickel-plated Brass
Contacts: Copper alloy with Gold over Nickel plating
Cables: A10—Yellow PVC jacket, 24 AWG PVC conductors, 300V, UL AWM2661
B09—Black PUR jacket, 24 AWG PVC conductors, 300V, 80° C, UL AWM 20549 (3-conductor)/AWM 21198 (5-conductor)

Environmental

Protection: IP67
NEMA Rating: NEMA 6

Poles (Female View)	Current per Contact	Max. Voltage	Cable Type	Cable Jacket (Cable Code)	Wire Size AWG	Length	Female Straight-to- Male Straight		Female Right Angle-to- Male Straight		Female Straight-to- Male Right Angle		Female Right Angle-to- Male Right Angle	
							Engineering No.	Standard Order No.	Engineering No.	Standard Order No.	Engineering No.	Standard Order No.	Engineering No.	Standard Order No.
 3 Pole 1 - Brown 4 - Black 3 - Blue	4.0A	60V AC/ 75V DC	UL 2661	PVC (A10)	24	1.0m	443030A10M010	120087-0074	443031A10M010	120087-0243	443032A10M010	120087-0253	443033A10M010	120087-0088
 4 Pole 1 - Brown 3 - Blue 2 - White 4 - Black	4.0A	60V AC/ 75V DC	UL 2661	PVC (A10)	24	1.0m	444030A10M010	120087-0093	444031A10M010	120087-0103	444032A10M010	120087-0281	444033A10M010	120087-0108
 5 Pole 1 - Brown 4 - Black 2 - White 5 - Gray 3 - Blue	3.0A	60V AC/ 75V DC	UL 2661	PVC (A10)	24	1.0m	445030A10M010	120087-0112	445031A10M010	120087-0287	445032A10M010	120087-0290	445033A10M010	120087-0117

Note: Sales drawings for all standard order numbers are available on molex.com.
Viton® is a registered trademark of E.I. DuPont De Nemours and Company.

Configuration Code*
Build-a-Part Number

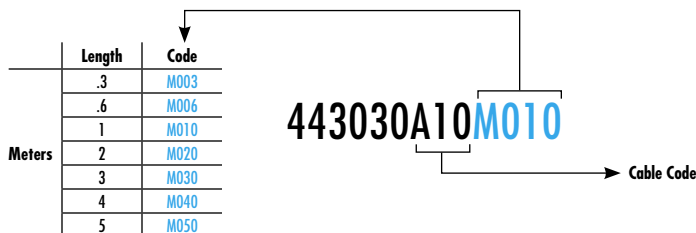

*Once an engineering number is created using the configuration code, consult Molex tech support for information regarding any part numbers.

Brad® Nano-Change® (M8) Receptacles (US)

120031/120090

Female
Front Panel Mount,
Back Panel Mount



Features and Benefits

- IEC compliant M8 panel mount receptacles
- Available in 3-, 4-, and 5-pole versions
- Fully potted assemblies provide IP67/68 protection for harsh environments
- Available in an array of configurations to fit your needs:
 - Various mounting thread sizes, including pipe threads for direct mounting on pipe fittings
 - Front panel mounts for installing from the outside of the enclosure
 - Back panel mount from inside the enclosure
 - Wire leads for terminating to terminal strips or PCB tails to incorporate with electronics

Physical

Shell Material: Nickel-plated Brass
 Contact Carries: PBT
 O-Ring: M8—Red Viton®
 Panel—Black Viton
 Contacts: Copper alloy with Gold over Nickel plating
 Wire PVC Insulation: 300V, 80° C, UL1007/1569, 24 AWG

Environmental

Protection: IP67
 NEMA Rating: NEMA 6

Reference Information

UL File No.: E152210

Poles	Max. Current per Contact	Max. Voltage	Configuration		Wire Type		Wire Size		Length	
			Engineering No.	Standard Order No.	Engineering No.	Standard Order No.	Engineering No.	Standard Order No.		
<p>3 Pole 4 3 1</p> <p>1 - Brown 4 - Black 3 - Blue</p>	4.0A	60V AC / 75V DC	4R3P00A27C300	120090-0016	4R3H40E02C3003	120031-0046	4R3H400013	120090-5001		
<p>4 Pole 4 2 3 1</p> <p>1 - Brown 3 - Blue 2 - White 4 - Black</p>	4.0A	60V AC / 75V DC	4R4P00A27C300	120090-0029	4R4H40E02C3003	120031-0022	4R4H400013	120031-0118		
<p>5 Pole 4 2 3 1 5</p> <p>1 - Brown 4 - Black 2 - White 5 - Gray 3 - Blue</p>	3.0A	60V AC / 75V DC	4R5P00A27C300	120090-0037	4R5H40E02C3003	120031-0050				

Note: Sales drawings for all standard order numbers are available on molex.com.
 Viton® is a registered trademark of E.I. DuPont De Nemours and Company.

Configuration Code*
 Build-a-Part Number

	Length	Code
Meters	0.3	C300
	1.0	M010

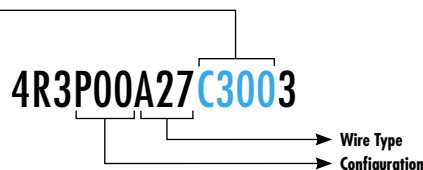

*Once an engineering number is created using the configuration code, consult Molex tech support for information regarding any part numbers.

Brad® Nano-Change® (M8) Receptacles (US)

120090

Male
Front Panel Mount



Features and Benefits

- IEC compliant M8 panel mount receptacles
- Mates with threaded and snap M8 cordsets
- Available in 3-, 4-, and 5-pole versions
- Fully potted assemblies provide IP67/68 protection for harsh environments
- Receptacles with wired leads to be used in control panels, junction boxes and sensors. Other configurations also available.

Reference Information

UL File No.: E152210

Physical

Shell Material: Nickel-plated Brass
Contact Carries: PBT
O-Ring: Panel—Black Viton®
Contacts: Copper alloy with Gold over Nickel plating
Wire PVC Insulation: 300V, 80° C, UL1007/1569, 24 AWG

Environmental

Protection: IP67
NEMA Rating: NEMA 6

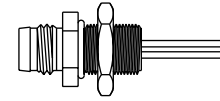

Configuration
Wire Type
Wire Size
Length

M8x0.5, Front Panel Mount
PVC Lead, UL1007/1569
24 AWG
0.3m

Poles	Max. Current per Contact	Max. Voltage	Engineering No.	Standard Order No.
<p>3 Pole</p> <p>1 - Brown 2 - Black 3 - Blue</p>	4.0A	60V AC / 75V DC	4R3P06A27C300	120090-0020
<p>4 Pole</p> <p>1 - Brown 2 - Blue 3 - White 4 - Black</p>	4.0A	60V AC / 75V DC	4R4P06A27C300	120090-0032
<p>5 Pole</p> <p>1 - Brown 2 - Black 3 - White 4 - Gray 5 - Blue</p>	3.0A	60V AC / 75V DC	4R5P06A27C300	120090-0038

Note: Sales drawings for all standard order numbers are available on molex.com.
Viton® is a registered trademark of E.I. DuPont De Nemours and Company.

Configuration Code*
Build-a-Part Number

	Length	Code
Meters	0.3	C300
	1.0	M010

4R3P06A27C3003

Wire Type
Configuration

*Once an engineering number is created using the configuration code, consult Molex tech support for information regarding any part numbers.

Brad® Nano-Change® (M8) Threaded Field Attachable Connectors (US)

120091

**Female, Male
Straight, Right Angle**



Features and Benefits

- Allows field termination of cables to IEC compliant, M8 circular connector
- Preassembled contact carrier with solder cup contacts for easy conductor termination
- Small, compact design for miniature sensors and space sensitive applications
- Available in 3- and 4-pole versions
- Back end housing and cable gland provides IP67 protection and strain relief

Physical

Connector Body: PA
Contact Carriers: PA
O-ring/Gaskets: NBR
Coupling Nut: Nickel-plated Brass
Contacts: Copper alloy with Gold over Nickel plating
Termination: Contacts with solder cups, accepts conductors up to 24 AWG (0.25mm²)

Environmental

Protection: IP67
NEMA Rating: NEMA 6

Female Connectors

Poles	Current per Contact	Max. Voltage	Cable Diameter Range	Female Straight		Female Right Angle	
				Engineering No.	Standard Order No.	Engineering No.	Standard Order No.
3 Pole 	4.0A	60V AC 75V DC	3.5-5.0mm (.137-.197")	N03FA03124	120091-0001	N03FA04124	120091-0003
4 Pole 	4.0A	60V AC 75V DC	3.5-5.0mm (.137-.197")	N04FA03124	120091-0007	N04FA04124	120091-0009

Male Connectors

Poles	Current per Contact	Max. Voltage	Cable Diameter Range	Male Straight		Male Right Angle	
				Engineering No.	Standard Order No.	Engineering No.	Standard Order No.
3 Pole 	4.0A	60V AC 75V DC	3.5-5.0mm (.137-.197")	N03MA03124	120091-0004	N03MA04124	120091-0006
4 Pole 	4.0A	60V AC 75V DC	3.5-5.0mm (.137-.197")	N04MA03124	120091-0010	N04MA04124	120091-0012

Note: Sales drawings for all standard order numbers are available on molex.com

Brad® Nano-Change® (M8) Distribution Boxes (US)

120113 Single Wired Ports with M16 HR Connector



Features and Benefits

- Fully potted, factory assembled boxes simplify on machine wiring installations
- Compact—small footprint for tight spaces
- Can be mounted in two orientations for added flexibility
- One input/output per port
- Indicating LEDs for power and sensor trigger indication
- M16 Home Run connector for easy replacement

Electrical

Voltage: 10-30V DC max.
Amperage: Module—6.0A max.
Port—2.0A max.

Physical

Housing: PBT
Port Shell Material: Nickel-plated Brass
Contacts: Copper alloy with Gold over Nickel plating
Home Run Connector: M16 14-pole male connector
Wiring Configuration: Single I/O, M8 3-pole female port
Operating Temperature: -25 to +90° C

Environmental

Protection: IP67
NEMA Rating: NEMA 6

Port Configuration	Box Configuration	Ports	LED Indicator	for Sensor	Engineering No	Standard Order No.
		4	Yes	PNP	BNY401P-FBC	120113-0023
		6	Yes	PNP	BNY601P-FBC	120113-0026
		8	Yes	PNP	BNY801P-FBC	120113-0029
		10	Yes	PNP	BNYA01P-FBC	120113-0020

Suggested Home Run Cable Assemblies

M16 14-pole Female Cordsets

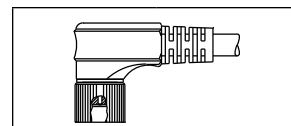

Use With	Cable Jacket	No. conductors	Cable Construction	Length	Engineering No.	Standard Order No.
4-port Block	PUR	6	Black PUR, 6x0.34mm ²	10.0m	L04301M78M100	130023-0063
6-port Block		8	Black PUR, 8x0.34mm ²		L04201M78M100	130023-0059
8-port Block		10	Black PUR, 10x0.34mm ²		L04101M78M100	130023-0055
10-port Block		12	Black PUR, 12x0.34mm ²		L04A01M78M100	130023-0068

Note: Sales drawings for all standard order numbers are available on molex.com

Brad® Nano-Change® (M8) Distribution Boxes (US)

120113 Single Wired Ports with PUR HR Cable



Features and Benefits

- Fully potted, factory assembled boxes simplify on machine wiring installations
- Compact—small footprint for tight spaces
- Can be mounted in two orientations for added flexibility
- One input/output per port
- Indicating LEDs for power and sensor trigger indication
- Integral Home Run cable eliminates need for purchase of additional component for installing

Electrical

Voltage: 10-30V DC max.
 Amperage: Module—6.0A max.
 Port—2.0A max.

Physical

Housing: PBT
 Port Shell Material: Nickel-plated Brass
 Contacts: Copper alloy with Gold over Nickel plating
 Wiring Configuration: Single I/O, M8 3-pole female port
 Home Run Cable: Black PUR cable, conductors:
 4-port—4x0.34mm² + 2x0.75mm²
 6-port—6x0.34mm² + 2x0.75mm²
 8-port—8x0.34mm² + 2x0.75mm²
 10-port—10x0.34mm² + 2x0.75mm²

Environmental

Protection: IP67
 NEMA Rating: NEMA 6

Port Configuration	Box Configuration	HR Cable Exit	Ports	LED Indicator	for Sensor	Length	Engineering No	Standard Order No
		End Exit	4	Yes	PNP	5.0m	BEY401P-FBP-05	120113-0006
			6	Yes	PNP	5.0m	BEY601P-FBP-05	120113-0011
			8	Yes	PNP	5.0m	BEY801P-FBP-05	120113-0014
			10	Yes	PNP	5.0m	BEYA01P-FBP-05	120113-0002
		Top Exit	4	Yes	PNP	5.0m	BNY401P-FBP-05	120113-0025
			8	Yes	PNP	5.0m	BNY801P-FBP-05	120113-0032
			10	Yes	PNP	5.0m	BNYA01P-FBP-05	120113-0022

Note: Sales drawings for all standard order numbers are available on molex.com

Configuration Code*
 Build-a-Part Number

	Length	Code
Meters	5	05
	10	10
	15	15

BNYA01P-FBP-05

Cable Code

*Once an engineering number is created using the configuration code, consult Molex tech support for information regarding any part numbers.

Brad® Nano-Change® (M8) Distribution Boxes (US)

120054/120113
Dual Wired Ports with PUR HR Cable



Features and Benefits

- Fully potted, factory assembled boxes simplify on machine wiring installations
- Compact—small footprint for tight spaces
- Can be mounted in two orientations for added flexibility
- One input/output per port
- Indicating LEDs for power and sensor trigger indication
- Integral Home Run cable eliminates need for purchase of additional component for installing

Electrical

Voltage: 10-30V DC max.
 Amperage: Module—6.0A max.
 Port—2.0A max.

Physical

Housing: PBT
 Port Shell Material: Nickel-plated Brass
 Contacts: Copper alloy with Gold over Nickel plating
 Wiring Configuration: Dual I/O, M8 4-pole female port
 Home Run Cable: Black PUR cable, conductors:
 4-port—8x0.34mm² + 2x0.75mm²
 6-port—12x0.34mm² + 2x0.75mm²
 8-port—16x0.34mm² + 2x0.75mm²
 10-port—20x0.25mm² + 2x0.50mm²

Environmental

Protection: IP67
 NEMA Rating: NEMA 6

Port Configuration	Box Configuration	HR Cable Exit	Ports	LED Indicator	for Sensor	Length	Engineering No	Standard Order No
		End Exit	4	Yes	PNP	5.0m	BEY403P-FBP-05	120054-0034
			6	Yes	PNP	5.0m	BEY603P-FBP-05	120054-0043
			8	Yes	PNP	5.0m	BEY803P-FBP-05	120113-0017
			10	Yes	PNP	5.0m	BEYA03P-FBP-05	120054-0045
		Top exit	4	Yes	PNP	5.0m	BNY403P-FBP-05	120113-5100
			6	Yes	PNP	5.0m	BNY603P-FBP-05	120054-0044
			8	Yes	PNP	5.0m	BNY803P-FBP-05	120054-0004
			10	Yes	PNP	5.0m	BNYA03P-FBP-05	120054-0046

Note: Sales drawings for all standard order numbers are available on molex.com

Configuration Code*
 Build-a-Part Number

	Length	Code
Meters	5	05
	10	10
	15	15

BEY803P-FBP-05

Cable Code

*Once an engineering number is created using the configuration code, consult Molex tech support for information regarding any part numbers.

Suggested Tee Splitter to Connect Two I/O per Port in Above Boxes

Wiring Schematic	Description	Engineering No	Standard Order No.
	Brad Nano-Change 'Y' Splitter	444A30	120089-5002

Brad® Nano-Change® (M8) Single-Ended Cordsets (US)

120088

**Female, Male Pigtails
Straight, Right Angle
Snap**



Features and Benefits

- IEC compliant M8 cordset assemblies with friction fit coupler design (snap design)
- Small, compact design for miniature sensors and space sensitive applications
- Available in 3 and 4 pole versions
- Push on to make connection, friction fit of snap feature keeps connection
- IP67 rated for harsh environments
- LED version provide power and signal trigger indication for PNP sensors (NPN versions available upon request)
- Wide selection of cables to fit applications:
 - PVC cables for light, cost-sensitive industrial applications
 - PUR cables for moderate flexing and for environments encountering cutting fluids and oils
 - Other types available upon request

Physical

Connector Body: TPE (PVC for LED version)
 Contact Carries: PBT
 O-ring: Viton®
 Coupling Nut: Nickel-plated Brass (male only)
 Contacts: Copper alloy with Gold over Nickel plating
 Cables: A10—Yellow PVC jacket, 24 AWG PVC conductors, 300V, UL AWM2661
 B09—Black PUR jacket, 24 AWG PVC conductors, 300V, 80° C, UL AWM 20549 (3 conductor)/AWM 21198 (5 conductor)

Environmental

Protection: IP67
 NEMA Rating: NEMA 6

Female Pigtails

Poles	Current per Contact	Max. Voltage	Cable Type	Cable Jacket (Cable Code)	Wire Size	Length	Female Straight		Female Right Angle		Female Right Angle with LEDs	
							Engineering No.	Standard Order No.	Engineering No.	Standard Order No.	Engineering No.	Standard Order No.
3 Pole 1 - Brown 4 - Black 3 - Blue	4.0A	60V AC / 75V DC	UL 2661	PVC (A10)	24 AWG	2.0m	503000A10M020	120088-0022	503001A10M020	120088-0032	5030P1A10M020	120088-0099
			UL 20549	PUR (B09)			503000B09M020	120088-0002	503001B09M020	120088-0040	5030P1B09M020	120088-0001
4 Pole 1 - Brown 3 - Blue 2 - White 4 - Black	4.0A	60V AC / 75V DC	UL 2661	PVC (E03)	24 AWG	2.0m			504001A10M020	120088-0054		
				PUR (B09)			504000B09M020	120088-0116	504001B09M020	120088-0130		

Male Pigtails

Poles	Current per Contact	Max. Voltage	Cable Type	Cable Jacket (Cable Code)	Wire Size	Length	Male Straight	
							Engineering No.	Standard Order No.
3 Pole 1 - Brown 4 - Black 3 - Blue	4.0A	60V AC / 75V DC	UL 2661	PVC (A10)	24 AWG	2.0m	503006A10M020	120088-0042
			UL 20549	PUR (B09)			503006B09M020	120088-0112
4 Pole 1 - Brown 3 - Blue 2 - White 4 - Black	4.0A	60V AC / 75V DC	UL 2661	PVC (E03)	24 AWG	2.0m	504006A10M020	120088-0059
				PUR (B09)			504006B09M020	120088-0014

Note: Sales drawings for all standard order numbers are available on molex.com.
 Viton® is a registered trademark of E.I. DuPont De Nemours and Company.

Configuration Code*
 Build-a-Part Number

	Length	Code
Meters	2	M020
	5	M050
	10	M100

503000A10M020

→ Cable Code

*Once an engineering number is created using the configuration code, consult Molex tech support for information regarding any part numbers.

Brad® Ultra-Lock® Connection System

EUROPE

Ultra

The performance and reliability of the revolutionary new Ultra-Lock® connection system surpass those of traditional threaded connectors, delivering increased productivity and cost savings.

Ultra-Lock connectors incorporate a unique radial seal and mechanical-locking design that deliver unsurpassed performance. The patented push-to-lock technology provides a fast, simple and secure operator-independent connection.

Ultra-Lock connectors are designed to eliminate connector-related intermittent signals in the harshest environments. Fewer intermittent signals mean less downtime and better productivity.

Ultra-Lock technology can be used on Ultra-Lock connectors as well as threaded connectors, including Brad M12 connectors from Molex and Micro-Push® (IP64) connections.

Molex offers Ultra-Lock in 3-, 4-, 5-, 8- and 12-pin configurations for an extensive assortment of cordsets, receptacles, and molded junction boxes. The Ultra-Lock receptacles and multiports can be used with conventional threaded M12 and Micro-Push products to provide backward compatibility to legacy screw-down connectors.

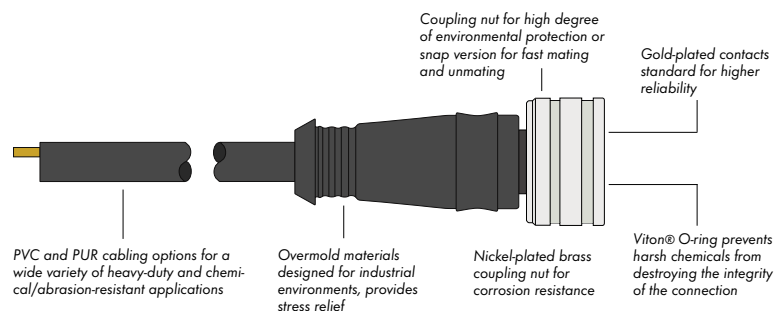

Features and Benefits

- Push-to-lock technology provides a simple, secure, operator-independent connection for fast mating and reduced installation time
- Radial O-ring provides an IP69K seal to protect against moisture
- Receptacles accept either the Ultra-Lock connector or standard M12 threaded cordsets, giving users a variety of connection options

Applications

- Proximity switches, photo eyes, safety switches and other I/O connectivity
- Connector interface for IP69-rated devices
- Connectivity for devices in high-vibration environments
- Connections requiring blind-mating

Viton® is a registered trademark of E.I. DuPont De Nemours and Company.

Brad® Ultra-Lock® (M12) Single-Ended Cordsets (Europe)

120079

Female, Pigtail
Straight, Right Angle



Features and Benefits

- Push-to-lock technology assures fast, reliable connections every time
- Reliable performance in high-vibration environment due to positive locking mechanism
- Ideal for wash-down and temporary submersion applications due to improved sealing design
- Ergonomic push to lock mechanisms reduces fatigue and user errors when a high number of connections need to be made
- 3-, 4-, and 5-pole versions are interchangeable for added flexibility
- IP67/68/69K rated for harsh environments
- Wide selection of cables to fit applications
 - PVC cables for light, cost-sensitive industrial applications
 - PUR cables for moderate flexing and for environments encountering cutting fluids and oils
 - TPE cables for moderate flex applications. Also ideal for welding cells, cable is weld slag resistant

Reference Information

CSA File No.: LR6837 (3-, 4-, and 5-pole assemblies)

Physical

Connector Body: PUR (TPE for K05)
 Contact Carries: Polyamide
 O-Ring: Viton® (EPDM for E03 cables)
 Coupling Nut: Nickel-plated Brass (Teflon® coated for K05)
 Contacts: Copper alloy with Gold over Nickel plating
 Cables: E03—Black PVC jacket, 0.34mm² PVC conductors, 300V, 80° C, UL AWM 2464
 P03/P02—Black PUR/PVC jacket, 0.34mm² (P03) or 0.25mm² (P02) PVC conductors, 300V, 80° C
 H09/H08—Black PUR jacket, 0.34mm² (H09) or 0.25mm² (H08) PVC conductors, 300V, 80° C, Low Smoke/Zero Halogen (LSOH), UL AWM 21198
 K05—Yellow TPE jacket, 22 AWG PVC conductors, 300V, UL PLTC-ER, +10M flex life (torsion and bending)
 H45—Black PUR jacket, 26 AWG PVC conductors, 300V, 80° C UL AWM 20549

Environmental

Protection: IP67/IP68/IP69K
 NEMA Rating: NEMA 6

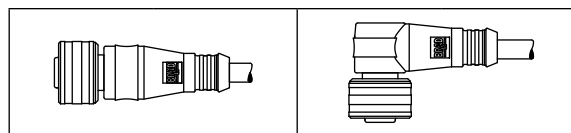

Poles	Max. Current per Contact	Max. Voltage	Cable Type	Cable Jacket	Wire Size	Length	Female Straight		Female Right Angle	
							Engineering No.	Standard Order No.	Engineering No.	Standard Order No.
3 Pole 	4.0A	250V AC/DC	UL 2464	PVC (E03)	0.34mm ²	2.0m	W03000E03M020	120079-5102	W03001E03M020	120079-5048
				PUR/PVC (P03)			W03000P03M020	120079-5103	W03001P03M020	120079-5104
			LSOH, UL 21198	PUR (H09)			W03000H09M020	120079-8042	W03001H09M020	120079-8047
			PLTC-ER	TPE (K05)			W03000K05M020	120079-0130	W03001K05M020	120079-0211
4 Pole 	4.0A	250V AC/DC	UL 2464	PVC (E03)	0.34mm ²	2.0m	W04000E03M020	120079-0266	W04001E03M020	120079-0269
				PUR/PVC (P03)			W04000P03M020	120079-8012	W04001P03M020	120079-8013
			LSOH, UL 21198	PUR (H09)			W04000H09M020	120079-8054	W04001H09M020	120079-8051
			PLTC-ER	TPE (K05)			W04000K05M020	120079-0149	W04001K05M020	120079-0221
5 Pole 	4.0A	250V AC/DC	UL 2464	PVC (E03)	0.34mm ²	2.0m	W05000E03M020	120079-0277	W05001E03M020	120079-0281
				PUR/PVC (P03)			W05000P03M020	120079-5110	W05001P03M020	120079-5088
			LSOH, UL 21198	PUR (H09)			W05000H09M020	120079-8045	W05001H09M020	120079-8048
8 Pole 	2.0A	30V AC/ 36V DC		PUR/PVC (P02)	0.25mm ²	2.0m	W08000P02M020	120079-5113	W08001P02M020	120079-5114
			LSOH, UL 21198	PUR (H08)			W08000H08M020	120079-5023	W08001H08M020	120079-8043
12 Pole 	1.5A	30V AC/DC	UL 20549	PUR (H45)	26 AWG	2.0m	W0C000H45M020	120079-5001	W0C001H45M020	120079-5117

Note: Sales drawings for all standard order numbers are available on molex.com.
 Teflon® and Viton® are registered trademarks of E.I. DuPont De Nemours and Company.

Configuration Code*
 Build-a-Part Number

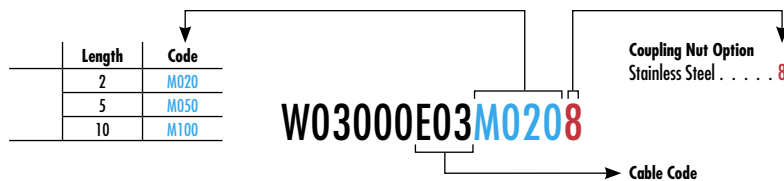

*Once an engineering number is created using the configuration code, consult Molex tech support for information regarding any part numbers.

Brad® Ultra-Lock® (M12) Single-Ended Cordsets (Europe)

120079

Male, Pigtail
Straight, Right Angle



Features and Benefits

- Push-to-lock technology assures fast, reliable connections every time
- Reliable performance in high-vibration environment due to positive locking mechanism
- Ideal for wash-down and temporary submersion applications due to improved sealing design
- Ergonomic push-to-lock mechanisms reduces fatigue and user errors when a high number of connections need to be made
- 3-, 4-, and 5-pole versions are intermatable for added flexibility
- IP67/68/69K rated for harsh environments
- Wide selection of cables to fit applications
 - PVC cables for light, cost-sensitive industrial applications
 - PUR cables for moderate flexing and for environments encountering cutting fluids and oils
 - TPE cables for moderate flex applications. Also ideal for welding cells, cable is weld slag resistant

Reference Information

CSA File No.: LR6837 (3-, 4-, and 5-pole assemblies)

Physical

Connector Body: PUR (TPE for K05)
 Contact Carries: Polyamide
 O-Ring: Viton® (EPDM for E03 cables)
 Coupling Nut: Nickel-plated Brass (Teflon® coated for K05)
 Contacts: Copper alloy with Gold over Nickel plating
 Cables: E03—Black PVC jacket, 0.34mm² PVC conductors, 300V, 80° C, UL AWM 2464
 P03/P02—Black PUR/PVC jacket, 0.34mm² (P03) or 0.25mm² (P02) PVC conductors, 300V, 80° C
 H09/H08—Black PUR jacket, 0.34mm² (H09) or 0.25mm² (H08) PVC conductors, 300V, 80° C, Low Smoke/Zero Halogen (LSOH), UL AWM 21198
 K05—Yellow TPE jacket, 22 AWG PVC conductors, 300V, UL PLTC-ER, +10M flex life (torsion and bending)
 H45—Black PUR jacket, 26 AWG PVC conductors, 300V, 80° C UL AWM 20549

Environmental

Protection: IP67/IP68/IP69K
 NEMA Rating: NEMA 6

Poles	Max. Current per Contact	Max. Voltage	Cable Type	Cable Jacket	Wire Size	Length	Male Straight		Male Right Angle	
							Engineering No.	Standard Order No.	Engineering No.	Standard Order No.
	4.0A	250V AC/DC	UL 2464	PVC (E03)	0.34mm ²	2.0m	W03006E03M020	120079-5105	W03007E03M020	120079-5107
				PUR/PVC (P03)			W03006P03M020	120079-5106	W03007P03M020	120020-0002
			LSOH, UL 21198	PUR (H09)			W03006H09M020	120079-8049	W03007H09M020	120079-8041
			PLTC-ER	TPE (K05)			W03006K05M020	120079-0155	W03007K05M020	120079-0226
	4.0A	250V AC/DC	UL 2464	PVC (E03)	0.34mm ²	2.0m	W04006E03M020	120079-0263	W04007E03M020	120079-5108
				PUR/PVC (P03)			W04006P03M020	120079-8006	W04007P03M020	120079-5109
			LSOH, UL 21198	PUR (H09)			W04006H09M020	120079-8053	W04007H09M020	120079-8052
			PLTC-ER	TPE (K05)			W04006K05M020	120079-0156	W04007K05M020	120079-0192
	4.0A	250V AC/DC	UL 2464	PVC (E03)	0.34mm ²	2.0m	W05006E03M020	120079-0273	W05007E03M020	120079-5111
				PUR/PVC (P03)			W05006P03M020	120079-5055	W05007P03M020	120079-5112
			LSOH, UL 21198	PUR (H09)			W05006H09M020	120079-8046	W05007H09M020	120079-8050
	2.0A	30V AC/ 36V DC		PUR/PVC (P02)	0.25mm ²	2.0m	W08006P02M020	120079-5115	W08007P02M020	120079-5116
			LSOH, UL 21198	PUR (H08)			W08006H08M020	120079-5026	W08007H08M020	120079-8044
	1.5A	30V AC/DC	UL 20549	PUR (H45)	26 AWG	2.0m	W0C006H45M020	120079-5006	W0C007H45M020	120079-5118

Note: Sales drawings for all standard order numbers are available on molex.com.
 Teflon® and Viton® are registered trademarks of E.I. DuPont De Nemours and Company.

Configuration Code*
Build-a-Part Number

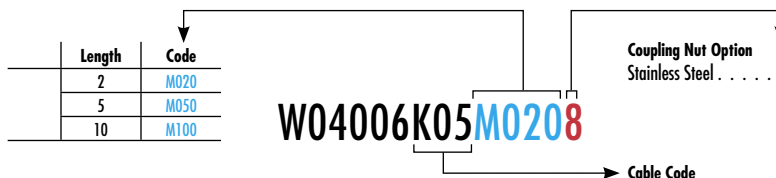

*Once an engineering number is created using the configuration code, consult Molex tech support for information regarding any part numbers.

Brad® Ultra-Lock® (M12) Double-Ended Cordsets (Europe)

120080

Female Straight-to-Male Straight,
Female Right Angle-to-Male
Straight



Features and Benefits

- Push-to-lock technology assures fast, reliable connections every time
- Reliable performance in high-vibration environment due to positive locking mechanism
- Ideal for wash-down and temporary submersion applications due to improved sealing design
- Ergonomic push-to-lock mechanisms reduces fatigue and user errors when a high number of connections need to be made
- 3-, 4-, and 5-pole versions are intermatable for added flexibility
- IP67/68/69K rated for harsh environments
- Wide selection of cables to fit applications
 - PVC cables for light, cost-sensitive industrial applications
 - PUR cables for moderate flexing and for environments encountering cutting fluids and oils
 - TPE cables for moderate flex applications. Also ideal for welding cells, cable is weld slag resistant

Reference Information

CSA File No.: LR6837 (3-, 4-, and 5-pole assemblies)

Physical

Connector Body: PUR (TPE for K05)
 Contact Carries: Polyamide
 O-Ring: Viton® (EPDM for E03 cables)
 Coupling Nut: Nickel-plated Brass (Teflon® coated for K05)
 Contacts: Copper alloy with Gold over Nickel plating
 Cables: E03—Black PVC jacket, 0.34mm² PVC conductors, 300V, 80° C, UL AWM 2464
 P03/P02—Black PUR/PVC jacket, 0.34mm² (P03) or 0.25mm² (P02) PVC conductors, 300V, 80° C
 H09/H08—Black PUR jacket, 0.34mm² (H09) or 0.25mm² (H08) PVC conductors, 300V, 80° C, Low Smoke/Zero Halogen (LSOH), UL AWM 21198
 K05—Yellow TPE jacket, 22 AWG PVC conductors, 300V, UL PLTC-ER, +10M flex life (torsion and bending)
 H45—Black PUR jacket, 26 AWG PVC conductors, 300V, 80° C UL AWM 20549

Environmental

Protection: IP67/IP68/IP69K
 NEMA Rating: NEMA 6

Poles (Female View)	Max. Current per Contact	Max. Voltage	Cable Type	Cable Jacket	Wire Size	Length	Female Straight-to-Male Straight		Female Right Angle-to-Male Straight	
							Engineering No.	Standard Order No.	Engineering No.	Standard Order No.
	4.0A	250V AC/DC	UL 2464	PVC (E03)	0.34mm ²	1.0m	WW3030E03M010	120080-5058	WW3031E03M010	120080-5060
				PUR/PVC (P03)			WW3030P03M010	120080-5059	WW3031P03M010	120080-5061
			LSOH, UL 21198	PUR (H09)			WW3030H09M010	120080-8026	WW3031H09M010	120080-8030
				PLTC-ER			TPE (K05)	WW3030K05M010	120080-0414	WW3031K05M010
	4.0A	250V AC/DC	UL 2464	PVC (E03)	0.34mm ²	1.0m	WW4030E03M010	120080-0469	WW4031E03M010	120080-5066
				PUR/PVC (P03)			WW4030P03M010	120080-5045	WW4031P03M010	120080-5067
			LSOH, UL 21198	PUR (H09)			WW4030H09M010	120080-8031	WW4031H09M010	120080-8027
				PLTC-ER			TPE (K05)	WW4030K05M010	120080-0417	WW4031K05M010
	4.0A	250V AC/DC	UL 2464	PVC (E03)	0.34mm ²	1.0m	WW5030E03M010	120080-5076	WW5031E03M010	120080-5077
				PUR/PVC (P03)			WW5030P03M010	120080-5050	WW5031P03M010	120080-5078
			LSOH, UL 21198	PUR (H09)			WW5030H09M010	120080-8039	WW5031H09M010	120080-8028
	2.0A	30V AC/ 36V DC		PUR/PVC (P02)	0.25mm ²	1.0m	WW8030P02M010	120080-5083	WW8031P02M010	120080-5084
			LSOH, UL 21198	PUR (H08)			WW8030H08M010	120080-8033	WW8031H08M010	120080-8034
	1.5A	30V AC/DC	UL 20549	PUR (H45)	26 AWG	1.0m	WWC030H45M010	120080-5088	WWC031H45M010	120080-5089

Note: Sales drawings for all standard order numbers are available on molex.com.

Teflon® and Viton® are registered trademarks of E.I. DuPont De Nemours and Company.

Configuration Code*
Build-a-Part Number

Length	Code
0.3	M003
0.6	M006
1	M010
2	M020
3	M030
4	M040
5	M050

WW8030P02M0108

Coupling Nut Option
Stainless Steel 8

Cable Code

*Once an engineering number is created using the configuration code, consult Molex tech support for information regarding any part numbers.

Brad® Ultra-Lock® (M12) Double-Ended Cordsets (Europe)

120080

**Female Straight-to-Male Right Angle,
Female Right Angle-to-Male Right Angle**



Features and Benefits

- Push-to-lock technology assures fast, reliable connections every time
- Reliable performance in high-vibration environment due to positive locking mechanism
- Ideal for wash-down and temporary submersion applications due to improved sealing design
- Ergonomic push-to-lock mechanisms reduces fatigue and user errors when a high number of connections need to be made
- 3-, 4-, and 5-pole versions are intermatable for added flexibility
- IP67/68/69K rated for harsh environments
- Wide selection of cables to fit applications
 - PVC cables for light, cost-sensitive industrial applications
 - PUR cables for moderate flexing and for environments encountering cutting fluids and oils
 - TPE cables for moderate flex applications. Also ideal for welding cells, cable is weld slag resistant

Reference Information

CSA File No.: LR6837 (3-, 4-, and 5-pole assemblies)

Physical

Connector Body: PUR (TPE for K05)
 Contact Carries: Polyamide
 O-Ring: Viton® (EPDM for E03 cables)
 Coupling Nut: Nickel-plated Brass (Teflon® coated for K05)
 Contacts: Copper alloy with Gold over Nickel plating
 Cables: E03—Black PVC jacket, 0.34mm² PVC conductors, 300V, 80° C, UL AWM 2464
 P03/P02—Black PUR/PVC jacket, 0.34mm² (P03) or 0.25mm² (P02) PVC conductors, 300V, 80° C
 H09/H08—Black PUR jacket, 0.34mm² (H09) or 0.25mm² (H08) PVC conductors, 300V, 80° C, Low Smoke/Zero Halogen (LSOH), UL AWM 21198
 K05—Yellow TPE jacket, 22 AWG PVC conductors, 300V, UL PLTC-ER, +10M flex life (torsion and bending)
 H45—Black PUR jacket, 26 AWG PVC conductors, 300V, 80° C UL AWM 20549

Environmental

Protection: IP67/IP68/IP69K
 NEMA Rating: NEMA 6

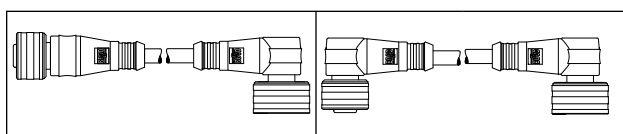

Poles (Female View)	Max. Current per Contact	Max. Voltage	Cable Type	Cable Jacket	Wire Size	Length	Female Straight-to-Male Right Angle		Female Right Angle-to-Male Right Angle	
							Engineering No.	Standard Order No.	Engineering No.	Standard Order No.
	4.0A	250V AC/DC	UL 2464	PVC (E03)	0.34mm ²	1.0m	WW3032E03M010	120080-5062	WW3033E03M010	120080-5064
				PUR/PVC (P03)			WW3032P03M010	120080-5063	WW3033P03M010	120080-5065
			LSOH, UL 21198	PUR (H09)			WW3032H09M010	120080-8029	WW3033H09M010	120080-8025
			PLTC-ER	TPE (K05)			WW3032K05M010	120080-0281	WW3033K05M010	120080-0364
	4.0A	250V AC/DC	UL 2464	PVC (E03)	0.34mm ²	1.0m	WW4032E03M010	120080-5068	WW4033E03M010	120080-5070
				PUR/PVC (P03)			WW4032P03M010	120080-5069	WW4033P03M010	120080-5071
			LSOH, UL 21198	PUR (H09)			WW4032H09M010	120080-8036	WW4033H09M010	120080-8037
			PLTC-ER	TPE (K05)			WW4032K05M010	120080-0306	WW4033K05M010	120080-0396
	4.0A	250V AC/DC	UL 2464	PVC (E03)	0.34mm ²	1.0m	WW5032E03M010	120080-5079	WW5033E03M010	120080-5081
				PUR/PVC (P03)			WW5032P03M010	120080-5080	WW5033P03M010	120080-5082
			LSOH, UL 21198	PUR (H09)			WW5032H09M010	120080-8038	WW5033H09M010	120080-8040
	2.0A	30V AC/ 36V DC		PUR/PVC (P02)	0.25mm ²	1.0m	WW8032P02M010	120080-5085	WW8033P02M010	120080-5086
			LSOH, UL 21198	PUR (H08)			WW8032H08M010	120080-8035	WW8033H08M010	120080-8032
	1.5A	30V AC/DC	UL 20549	PUR (H45)	26 AWG	1.0m	WWC032H45M010	120080-5090	WWC033H45M010	120080-5023

Note: Sales drawings for all standard order numbers are available on molex.com.
 Teflon® and Viton® are registered trademarks of E.I. DuPont De Nemours and Company.

Configuration Code*
 Build-a-Part Number



*Once an engineering number is created using the configuration code, consult Molex tech support for information regarding any part numbers.

Brad® Ultra-Lock® (M12) Single and Double-Ended Shielded Cordsets (Europe)

120079/120083

**Female Straight, Male Straight,
Female Straight-to-Male Straight**



Features and Benefits

- Push-to-lock technology assures fast, reliable connections every time
- Reliable performance in high-vibration environment due to positive locking mechanism
- Ideal for wash-down and temporary submersion applications due to improved sealing design
- Ergonomic push-to-lock mechanisms reduces fatigue and user errors when a high number of connections need to be made
- Shielding thru coupling offer complete EMI protection to electrical noise
- IP67/68/69K rated for harsh environments

Physical

Connector Body: PUR
 Contact Carries: Polyamide
 O-Ring: Viton®
 Coupling Nut: Nickel-plated Brass
 Contacts: Copper alloy with Gold over Nickel plating
 Shielding: Braid Shield on cable connected to coupler, providing complete shielding thru connector interface
 Cables: P19—Black PUR jacket with Braid Shield, 85% coverage, 0.34mm² PVC conductors, 300V, 90C
 P45—Black PUR jacket with Braid Shielded, 80% coverage, 26 AWG PVC conductors, 300V, 80C, UL AWM 20549

Environmental

Protection: IP67/IP68/IP69K
 NEMA Rating: NEMA 6

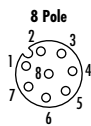
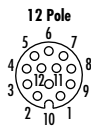
Poles (Female View)	Max. Current per Contact	Max. Voltage	Cable Type	Cable Jacket (Cable Code)	Wire Size	Length	Female Straight		Male Straight		Female Straight-to-Male Straight	
							Engineering No.	Standard Order No.	Engineering No.	Standard Order No.	Engineering No.	Standard Order No.
 8 Pole	2.0A	30V AC/36V DC	UL 20327	PUR/PVC (P19)	0.25mm ²	1.0m					WW8S30P19M010	120083-5183
						2.0m	W08S00P19M020	120079-5029	W08S06P19M020	120079-5033		
 12 Pole	1.5A	30V AC/DC	UL 1581	PUR (P45)	26 AWG	1.0m					WWCS30P45M010	120083-5044
						2.0m	W0CS00P45M020	120083-5010	W0CS06P45M020	120083-5015		

Note: Sales drawings for all standard order numbers are available on molex.com.
 Viton® is a registered trademark of E.I. DuPont De Nemours and Company.

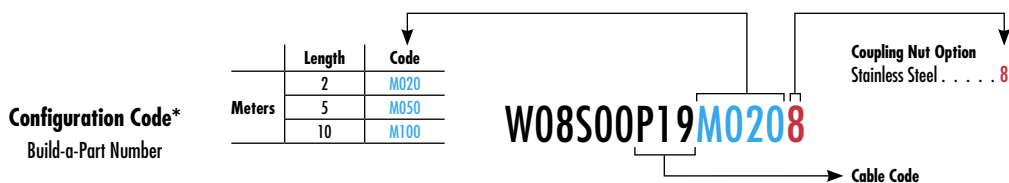

*Once an engineering number is created using the configuration code, consult Molex tech support for information regarding any part numbers.

Brad® Ultra-Lock® (M12) Receptacles (Europe)

120084

**Female
Front Panel Mount,
Back Panel Mount**



Features and Benefits

- M12 single keyway (A-Coding) IEC compliant panel mount receptacles with Ultra-Lock feature
- Mates with standard threaded M12 and Ultra-Lock cordsets
- Available in 4-, 5-, 8- and 12-pole configurations
- Fully potted assemblies provide IP67/68 protection for harsh environments
- Available in an array of configurations to fit your needs:
 - Various mounting thread sizes, including pipe threads for direct mounting on pipe fittings
 - Front panel mounts for installing from the outside of the enclosure
 - Back panel mount from inside the enclosure
 - Wire leads for terminating to terminal strips or PCB tails to incorporate with electronics

Reference Information

cSAus Certified LR6837 (4- to 5-pole version)

Physical

Shell Material: Nickel-plated Brass

Contact Carries: Polyamide

O-Ring: M12—Red Viton®
Panel—Black Viton

Contacts: Copper alloy with Gold over Nickel plating

Wire PVC Insulation: 300V, 80° C, UL1061
4-, 5-poles—0.34mm²
8-poles—0.25mm²
12-poles—0.14mm²

Environmental

Protection: IP67

NEMA Rating: NEMA 6

Poles	Max. Current per Contact	Max. Voltage	Configuration		Wire Type		Wire Size		Length	
			Engineering No.	Standard Order No.	Engineering No.	Standard Order No.	Engineering No.	Standard Order No.	Engineering No.	Standard Order No.
4 Pole 	4.0A	250V AC/DC	WR4J20E03C3003	120084-5154	WR4U20E03C3003	120084-5107	WR4W40E03C3003	120084-5189	WR4W400003	120084-5175
5 Pole 	4.0A	250V AC/DC	WR5J20E03C3003	120084-5159	WR5U20E03C3003	120084-5113	WR5W40E03C3003	120084-5190	WR5W400003	120084-5179
8 Pole 	2.0A	30V AC / 36V DC			WR8U20E02C3003	120084-5095	WR8W40E02C300	120084-5191	WR8W400003	120084-0048
12 Pole 	1.5A	30V AC/DC			WRCU20E01C3003	120084-5013	WRCW40E01C300	120084-5192	WRCW400003	120084-5176

Note: Sales drawings for all standard order numbers are available on molex.com.
Viton® is a registered trademark of E.I. DuPont De Nemours and Company.

Configuration Code*
Build-a-Part Number

	Length	Code
Meters	0.3	C300
	1.0	M010

WR8U20E02C3003

→ Wire Type
→ Configuration

*Once an engineering number is created using the configuration code, consult Molex tech support for information regarding any part numbers.

Brad® Ultra-Lock® (M12) Receptacles (Europe)

120084

Male

Front Panel Mount,
Back Panel Mount



Features and Benefits

- M12 single keyway (A-Coding) IEC compliant panel mount receptacles with Ultra-Lock feature
- Mates with standard threaded M12 and Ultra-Lock cordsets
- Available in 4-, 5-, 8- and 12-pole configurations
- Fully potted assemblies provide IP67/68 protection for harsh environments
- Available in an array of configurations to fit your needs:
 - Various mounting thread sizes, including pipe threads for direct mounting on pipe fittings
 - Front panel mounts for installing from the outside of the enclosure
 - Back panel mount from inside the enclosure
 - Wire leads for terminating to terminal strips or PCB tails to incorporate with electronics

Reference Information

cCSAus Certified LR6837 (4- to 5-pole version)





Physical

Shell Material: Nickel-plated Brass
 Contact Carries: Polyamide
 O-Ring: Panel—Black Viton®
 Contacts: Copper alloy with Gold over Nickel plating
 Wire PVC Insulation: 300V, 80° C, UL1061
 4, 5-poles—0.34mm²
 8-poles—0.25mm²
 12-poles—0.14mm²

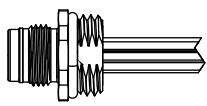
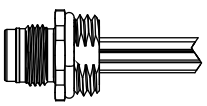
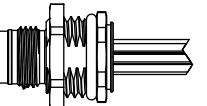
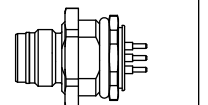
Environmental

Protection: IP67
 NEMA Rating: NEMA 6

Configuration	Wire Type	Wire Size	Length
	PG9, Front Panel Mount	PVC leads, UL1061	0.34mm ²
	M16x1.5, Front Panel Mount	PVC leads, UL1061	0.34mm ² (4- to 5-pole), 0.25mm ² (8-pole), 0.14mm ² (12-pole)
	M16x1.5, Back Panel Mount	PVC leads, UL1061	0.34mm ² (4- to 5-pole), 0.25mm ² (8-pole), 0.14mm ² (12-pole)
	M16x1.5, Back Panel Mount	PCB Pins	

Poles	Max. Current per Contact	Max. Voltage	Engineering No.	Standard Order No.	Engineering No.	Standard Order No.	Engineering No.	Standard Order No.	Engineering No.	Standard Order No.
	4.0A	250V AC/DC	WR4J26E03C3003	120084-5103	WR4U26E03C3003	120084-5108	WR4W46E03C3003	120084-5183	WR4W460003	120084-5180
	4.0A	250V AC/DC	WR5J26E03C3003	120084-5109	WR5U26E03C3003	120025-0007	WR5W46E03C3003	120084-5185	WR5W460003	120084-5181
	2.0A	30V AC / 36V DC			WR8U26E02C3003	120084-5096	WR8W46E02C300	120084-5187	WR8W460003	120084-0047
	1.5A	30V AC/DC			WRCU26E01C3003	120084-5015	WRCW46E01C300	120084-5188	WRCW460003	120084-5182

Note: Sales drawings for all standard order numbers are available on molex.com.
 Viton® is a registered trademark of E.I. DuPont De Nemours and Company.

Configuration Code*
 Build-a-Part Number

	Length	Code
Meters	0.3	C300
	1.0	M010

WR4J26E03C3003

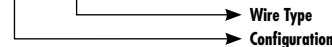

*Once an engineering number is created using the configuration code, consult Molex tech support for information regarding any part numbers.

Brad® Ultra-Lock® (M12) Field Attachable Connectors (Europe)

120085

**Female, Male
Straight, Right Angle**



Features and Benefits

- Allows field termination of cables to Ultra-Lock, push-to-lock connector
- Preassembled contact carries with screw terminals provides easy field termination of conductors
- Available in 4- and 5-pole versions
- Back end housing and cable gland provides IP67 protection and strain relief

Physical

Connector Body: PA
Contact Carries: PA
O-ring: Viton®
Coupling Nut: Nickel-plated Brass
Contacts: Copper alloy with Gold over Nickel plating
Termination: Screw down terminals, accepts conductors up to 18 AWG (0.75mm²)

Environmental

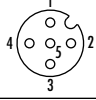

Protection: IP67/IP68/IP69K
NEMA Rating: NEMA 6

Female Connectors

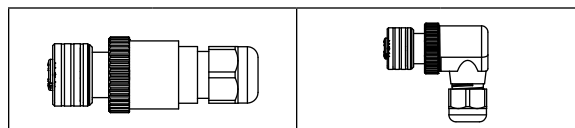
Poles	Current per Contact	Max. Voltage	Cable Diameter Range	Female Straight		Female Right Angle	
				Engineering No.	Standard Order No.	Engineering No.	Standard Order No.
	4.0A	250V AC 300V DC	3.30-6.60mm (.130-.260")	WA4000-31	120085-0011	WA4001-31	120085-0015
			4.10-8.10mm (.161-.319")	WA4000-32	120085-0013		
	4.0A	30V AC 36V DC	3.30-6.60mm (.130-.260")	WA5000-31	120085-0012	WA5001-31	120085-0016
			4.10-8.10mm (.161-.319")	WA5000-32	120085-0014		



Male Connectors

Poles	Current per Contact	Max. Voltage	Cable Diameter Range	Male Straight		Male Right Angle	
				Engineering No.	Standard Order No.	Engineering No.	Standard Order No.
	4.0A	250V AC 300V DC	3.30-6.60mm (.130-.260")	WA4006-31	120085-0003	WA4007-31	120085-0007
			4.10-8.10mm (.161-.319")	WA4006-32	120085-0005		
	4.0A	30V AC 36V DC	3.30-6.60mm (.130-.260")	WA5006-31	120085-0004	WA5007-31	120085-0008
			4.10-8.10mm (.161-.319")	WA5006-32	120085-0006		

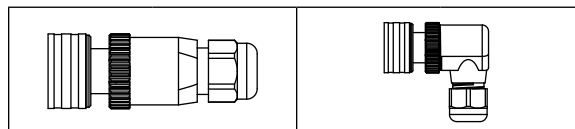

Note: Sales drawings for all standard order numbers are available on molex.com.
Viton® is a registered trademark of E.I. DuPont De Nemours and Company.

Brad® Ultra-Lock® (M12) Splitter Cordsets (Europe)

120080

Female Straight-to-Male Straight, Female Right Angle-to-Male Straight



Features and Benefits

- Splitters permit the connection of two I/O devices to a Brad Ultra-Lock port on dual-wired distribution boxes
- Push-to-lock technology assures fast, reliable connections every time
- IP67/68 rated for harsh environments
- Reliable performance in high-vibration environments due to positive locking mechanism
- Wide selection of cables to fit applications
 - PVC cables for light, cost-sensitive industrial applications
 - PUR cables for moderate flexing and for environments encountering cutting fluids and oils
 - TPE cables for continuous flex applications. Also ideal for welding cells; cable is weld slag resistant

Reference Information (K05 cable assemblies)

UL File No.: E152210

CSA File No.: LR6837

Physical

Connector Body: PUR (TPE for K05)

Contact Carries: Polyamide

O-ring: Viton® (EPDM for E03 cables)

Coupling Nut: Nickel-plated Brass (Teflon® coated for K05)

Contacts: Copper alloy with Gold over Nickel plating

Cables: E03—Black PVC jacket, 0.34mm² PVC conductors, 300V, 80° C, UL AWM 2464

P03—Black PUR/PVC jacket, 0.34mm² PVC conductors, 300V, 80° C

H09—Black PUR jacket, 0.34mm² PVC conductors, 300V, 80° C, Low Smoke/Zero Halogen (LSOH), UL AWM 21198

K05—Yellow TPE jacket, 22 AWG PVC conductors, 300V, UL PLTC-ER, +10M flex life (torsion and bending)

Environmental

Protection: IP67

NEMA Rating: NEMA 6

Ultra-Lock-to-Ultra-Lock Splitters

Wiring Schematic	Max. Current per Contact	Max. Voltage	Cable Type	Cable Jacket (Cable Code)	Wire Size	Length	Female Straight-to-Male Straight		Female Right Angle-to-Male Straight	
							Engineering No.	Standard Order No.	Engineering No.	Standard Order No.
	4.0A	250V AC/DC	UL 2464	PVC (E03)	0.34mm ²	0.3m	WW4A30E03M003	120080-5072	WW4A31E03M003	120080-5074
				PUR/PVC (P03)	0.34mm ²	0.3m	WW4A30P03M003	120080-5073	WW4A31P03M003	120080-5075
			LSOH, UL 21198	PUR (H09)	0.34mm ²	0.3m	WW4A30H09M003	120080-8048	WW4A31H09M003	120080-8049
				PLTC-ER	TPE (K05)	0.34mm ²	0.3m	WW4A30K05M003	120080-0081	WW4A31K05M003

Ultra-Lock-to-Micro-Change® Splitters

Wiring Schematic	Max. Current per Contact	Max. Voltage	Cable Type	Cable Jacket (Cable Code)	Wire Size	Length	Female Straight-to-Male Straight		Female Right Angle-to-Male Straight	
							Engineering No.	Standard Order No.	Engineering No.	Standard Order No.
	4.0A	250V AC/DC	UL 2464	PVC (E03)	0.34mm ²	0.3m	8W4A30E03M003	120080-5092	8W4A31E03M003	120080-5094
				PUR/PVC (P03)	0.34mm ²	0.3m	8W4A30P03M003	120080-5093	8W4A31P03M003	120080-5095
			LSOH, UL 21198	PUR (H09)	0.34mm ²	0.3m	8W4A30H09M003	120082-8004	8W4A31H09M003	120080-8024
				PLTC-ER	TPE (K05)	0.34mm ²	0.3m	8W4A30K05M003	120080-0108	8W4A31K05M003

Note: Sales drawings for all standard order numbers are available on molex.com.

Teflon® and Viton® are registered trademarks of E.I. DuPont De Nemours and Company.

Configuration Code†
Build-a-Part Number

Length	Code
0.3	M003
0.6	M006
1.0	M010
3.0	M030
5.0	M050

Meters

Coupling Nut Option
Stainless Steel 8

WW4A30E03M0038

†Once an engineering number is created using the configuration code, consult Molex tech support for information regarding any part numbers.

Brad® Ultra-Lock® (M12) Distribution Boxes (Europe)

120119/130008

Top Mount, Single-Wired Ports With Brad® Mini-Change® HR Connector



Features and Benefits

- Fully potted, factory assembled boxes simplify on machine wiring installations
- Accepts Ultra-Lock and threaded M12 cordsets
- One input/output per port
- Indicating LEDs for power and sensor trigger indication
- Versions available for use with PNP and NPN sensors
- Mini-Change home run connector for easy replacement

Electrical

Voltage: 10 to 30V DC max.
Amperage: Module—12.0A max.
Port—4.0A max.

Physical

Housing: PBT
Port Shell Material: Nickel-plated Brass
Contacts: Copper alloy with Gold over Nickel plating
Home Run Connector: Mini-Change 12-pole male connector
Wiring Configuration: Single I/O, M12 4-pole female port

Environmental

Protection: IP67
NEMA Rating: NEMA 6

Port Configuration	Box Configuration	Ports	LED Indicator	For Sensor	Top Mount	
					Engineering No.	Standard Order No.
		4	Yes	PNP	BKY401P-FBB	120119-0002
		6	Yes	PNP	BKY601P-FBB	120119-0010
		8	Yes	PNP	BKY801P-FBB	120119-0017

Suggested Home Run Cordset Brad Mini-Change 12-pole Female Cordset

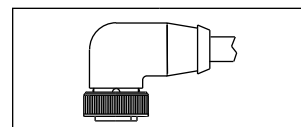

Use With	Cable Jacket	No. of Conductors	Construction	Length	Engineering No.	Standard Order No.
4-port block	PUR	7	4 × 0.34mm ² + 3 × 0.75mm ²	10.0m	302301P80M100	130008-8009
6-port block		8	6 × 0.34mm ² + 3 × 0.75mm ²		302201P80M100	130008-8006
8-port block		9	8 × 0.34mm ² + 3 × 0.75mm ²		302101P80M100	130008-0476

Note: Sales drawings for all standard order numbers are available on molex.com

Configuration Code*
Build-a-Part Number

	Length	Code
Meters	5	050
	10	100
	15	150

302301P80M100

*Once an engineering number is created using the configuration code, consult Molex tech support for information regarding any part numbers.

Brad® Ultra-Lock® (M12) Distribution Boxes (Europe)

120119/130008

Top Mount, Dual-Wired Ports With Brad® Mini-Change® HR Connector



Features and Benefits

- Fully potted, factory assembled boxes simplify on machine wiring installations
- Accepts Ultra-Lock and threaded M12 cordsets
- Two input/outputs per port
- Indicating LEDs for power and sensor trigger indication
- Versions available for use with PNP and NPN sensors
- Mini-Change Home Run connector for easy replacement

Electrical

Voltage: 10 to 30V DC max.
Amperage: Module—12.0A max.
Port—4.0A max.

Physical

Housing: PBT
Port Shell Material: Nickel-plated Brass
Contacts: Copper alloy with Gold over Nickel plating
Home Run Connector: Mini-Change® 19-pole male connector
Wiring Configuration: Dual I/O, M12 5-pole female port

Environmental

Protection: IP67
NEMA Rating: NEMA 6

Port Configuration	Box Configuration	Ports	LED Indicator	For Sensor	Top Mount	
					Engineering No.	Standard Order No.
		4	Yes	PNP	BKY403P-FBB	120119-0005
		6	Yes	PNP	BKY603P-FBB	120119-0013
		8	Yes	PNP	BKY803P-FBB	120119-0020

Suggested Home Run Cordset Brad Mini-Change 19-pole Female Cordset

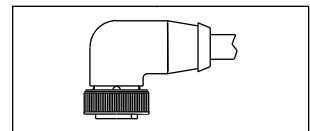

Use With	Cable Jacket	No. of Conductors	Construction	Length	Engineering No.	Standard Order No.
4 and 6-port blocks	PUR	15	12 × 0.34mm ² + 3 × 0.75mm ²	10.0m	303201P80M100	130008-5006
8-port block	PUR	19	16 × 0.34mm ² + 3 × 0.75mm ²	10.0m	303001P80M100	130008-0316

Note: Sales drawings for all standard order numbers are available on molex.com

Configuration Code*
Build-a-Part Number

Meters	Length	Code
	5	050
10	100	
15	150	

303001P80M100

*Once an engineering number is created using the configuration code, consult Molex tech support for information regarding any part numbers.

Brad® Ultra-Lock® (M12) Distribution Boxes (Europe)

120119/120094/120230
Top Mount, Single-Wired Ports With M23 HR Connector



Features and Benefits

- Fully potted, factory assembled boxes simplify on machine wiring installations
- Accepts Ultra-Lock and threaded M12 cordsets
- One input/output per port
- Indicating LEDs for power and sensor trigger indication
- Versions available for use with PNP and NPN sensors
- M23 Home Run connector for easy replacement

Electrical

Voltage: 10 to 30V DC max.
 Amperage: Module—12.0A max.
 Port—4.0A max.

Physical

Housing: PBT
 Port Shell Material: Nickel-plated Brass
 Contacts: Copper alloy with Gold over Nickel plating
 Home Run Connector: M23 12-pole male connector
 Wiring Configuration: Single I/O, M12 4-pole female port

Environmental

Protection: IP67
 NEMA Rating: NEMA 6

Port Configuration	Box Configuration	Ports	LED Indicator	For Sensor	Top Mount	
					Engineering No.	Standard Order No.
		4	Yes	PNP	BKY401P-FBC	120119-0003
		6	Yes	PNP	BKY601P-FBC	120119-0011
		8	Yes	PNP	BKY801P-FBC	120119-0018

Suggested Home Run Cable Assemblies M23 12-pole Female Cordset and Field Attachable Connector

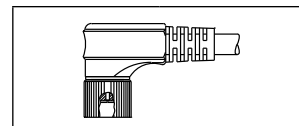

Use With	Cable Jacket	No. of Conductors	Construction	Length	Engineering No.	Standard Order No.
4-port	PUR	7	4 × 0.34mm ² + 3 × 0.75mm ²	10.0m	K02301P80M100	120094-5023
6-port		9	6 × 0.34mm ² + 3 × 0.75mm ²		K02201P80M100	120094-8013
8-port		11	8 × 0.34mm ² + 3 × 0.75mm ²		K02101P80M100	120094-0125
All	M23 12p Female Field Attachable Kit				KASC500-025	120230-0032

Note: Sales drawings for all standard order numbers are available on molex.com

Configuration Code*
 Build-a-Part Number

	Length	Code
Meters	5	050
	10	100
	15	150

K02101P80M100

*Once an engineering number is created using the configuration code, consult Molex tech support for information regarding any part numbers.

Brad® Ultra-Lock® (M12) Distribution Boxes (Europe)

120119/120055

Top Mount, Dual-Wired Ports With M23 HR Connector



Features and Benefits

- Fully potted, factory assembled boxes simplify on machine wiring installations
- Accepts Ultra-Lock and threaded M12 cordsets
- Two input/outputs per port
- Indicating LEDs for power and sensor trigger indication
- Versions available for use with PNP and NPN sensors
- M23 Home Run connector for easy replacement

Electrical

Voltage: 10 to 30V DC max.
Amperage: Module—12.0A max.
Port—4.0A max.

Physical

Housing: PBT
Port Shell Material: Nickel-plated Brass
Contacts: Copper alloy with Gold over Nickel plating
Home Run Connector: M23 19-pole male connector
Wiring Configuration: Dual I/O, M12 5-pole female port

Environmental

Protection: IP67
NEMA Rating: NEMA 6

Port Configuration	Box Configuration	Ports	LED Indicator	For Sensor	Top Mount	
					Engineering No.	Standard Order No.
		4	No		BKY4030-FBC	120119-0038
		8			BKY8030-FBC	120055-0925
		4	Yes	PNP	BKY403P-FBC	120119-0006
		8			BKY803P-FBC	120119-0021

Suggested Home Run Cable Assemblies M23 19-pole Female Cordset and Field Attachable Connector

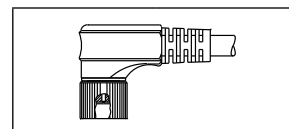

Use With	Cable Jacket	No. of Conductors	Construction	Length	Engineering No.	Standard Order No.
4-port	PUR	11	$8 \times 0.34\text{mm}^2 + 3 \times 0.75\text{mm}^2$	10.0m	K03301P80M100	120094-8045
6-port		15	$12 \times 0.34\text{mm}^2 + 3 \times 0.75\text{mm}^2$		K03201P80M100	120094-8027
8-port		19	$16 \times 0.34\text{mm}^2 + 3 \times 0.75\text{mm}^2$		K03001P80M100	120094-0044

Note: Sales drawings for all standard order numbers are available on molex.com

Configuration Code*
Build-a-Part Number

	Length	Code
Meters	5	M050
	10	M100
	15	M150

K03301P80M100

*Once an engineering number is created using the configuration code, consult Molex tech support for information regarding any part numbers.

Brad® Ultra-Lock® (M12) Distribution Boxes (Europe)

120119

Top Mount, Dual-Wired Ports with
Field Attachable HR Terminal Strip



Features and Benefits

- Fully potted, factory assembled boxes simplify on machine wiring installations
- Accepts Ultra-Lock and threaded M12 cordsets
- Two input/outputs per port
- Indicating LEDs for power and sensor trigger indication
- Versions available for use with PNP and NPN sensors
- Home Run terminal strip provides greatest flexibility for cable choices and trimming to length on machine

Electrical

Voltage: 10 to 30V DC max.
Amperage: Module—12.0A max.
Port—4.0A max.

Physical

Housing: PBT
Port Shell Material: Nickel-plated Brass
Contacts: Copper alloy with Gold over Nickel plating
Home Run Connector: Terminal strip
Wiring Configuration: Dual I/O, M12 5-pole female

Environmental

Protection: IP67
NEMA Rating: NEMA 6

Port Configuration	Box Configuration	Ports	LED Indicator	For Sensor	Top Mount	
					Engineering No.	Standard Order No.
		4	Yes	PNP	BKY403P-FBA	120119-0004
		6	Yes	PNP	BKY603P-FBA	120119-0012
		8	Yes	PNP	BKY803P-FBA	120119-0019

Brad® Ultra-Lock® (M12) Distribution Boxes (Europe)

120119

Top Mount, Single-Wired Ports With PUR HR Cable



Features and Benefits

- Fully potted, factory assembled boxes simplify on machine wiring installations
- Accepts Ultra-Lock and threaded M12 cordsets
- One input/output per port
- Indicating LEDs for power and sensor trigger indication
- Versions available for use with PNP and NPN sensors
- Integral Home Run cable eliminates need for purchase of additional component for installation

Electrical

Voltage: 10 to 30V DC max.
Amperage: Module—12.0A max.
Port—4.0A max.

Physical

Housing: PBT
Port Shell Material: Nickel-plated Brass
Contacts: Copper alloy with Gold over Nickel plating
Wiring Configuration: Single I/O, M12 4-pole female port
Home Run Cable: Black PUR cable, conductors:
4-port—4 × 0.34mm² + 3 × 0.75 mm²
6-port—6 × 0.34mm² + 3 × 0.75 mm²
8-port—8 × 0.34mm² + 3 × 0.75 mm²

Environmental

Protection: IP67
NEMA Rating: NEMA 6

Port Configuration	Box Configuration	Ports	LED Indicator	For Sensor	Cable Length	Top Mount	
						Engineering No.	Standard Order No.
		4	Yes	PNP	5.0m	BKY400P-FBP-05	120119-0001
		6	Yes	PNP	5.0m	BKY600P-FBP-05	120119-0009
		8	Yes	PNP	5.0m	BKY800P-FBP-05	120119-0016

Note: Sales drawings for all standard order numbers are available on molex.com

Configuration Code*
Build-a-Part Number

	Length	Code
Meters	5	05
	10	10
	15	15

BKY800P-FBP-05

*Once an engineering number is created using the configuration code, consult Molex tech support for information regarding any part numbers.

Brad® Ultra-Lock® (M12) Distribution Boxes (Europe)

120119
Dual-Wired Ports with PUR HR Cable



Features and Benefits

- Fully potted, factory assembled boxes simplify on machine wiring installations
- Accepts Ultra-Lock and threaded M12 cordsets
- Two input/outputs per port
- Indicating LEDs for power and sensor trigger indication
- Versions available for use with PNP and NPN sensors
- Integral Home Run cable eliminates need for purchase of additional component for installation

Electrical

Voltage: 10 to 30V DC max.
Amperage: Module—12.0A max.
Port—4.0A max.

Physical

Housing: PBT
Port Shell Material: Nickel-plated Brass
Contacts: Copper alloy with Gold over Nickel plating
Wiring Configuration: Dual I/O, M12 5-pole female port
Home Run Cable: Black PUR cable, conductors:
4-port— $8 \times 0.34\text{mm}^2 + 3 \times 0.75\text{mm}^2$
6-port— $12 \times 0.34\text{mm}^2 + 3 \times 0.75\text{mm}^2$
8-port— $16 \times 0.34\text{mm}^2 + 3 \times 0.75\text{mm}^2$

Environmental

Protection: IP67
NEMA Rating: NEMA 6

Port Configuration	Box Configuration	Ports	LED Indicator	For Sensor	Cable Length	Top Mount	
						Engineering No.	Standard Order No.
		4	Yes	PNP	5.0m	BKY405P-FBP-05	120119-0007
		6	Yes	PNP	5.0m	BKY605P-FBP-05	120119-0015
		8	Yes	PNP	5.0m	BKY805P-FBP-05	120119-0023

Note: Sales drawings for all standard order numbers are available on molex.com

Configuration Code*
Build-a-Part Number

	Length	Code
Meters	5	05
	10	10
	15	15

BKY405P-FBP-05

*Once an engineering number is created using the configuration code, consult Molex tech support for information regarding any part numbers.

Brad® Ultra-Lock® (M12) Distribution Boxes (Europe)

120119

Top Mount, Dual-Wired Ports with Molded Brad® Mini-Change® HR Cordset



Features and Benefits

- Fully potted, factory assembled boxes simplify on machine wiring installations
- Accepts Ultra-Lock and threaded M12 cordsets
- Two input/outputs per port
- Indicating LEDs for power and sensor trigger indication
- Versions available for use with PNP and NPN sensors
- Integral Home Run cordset with Mini-Change® 19-pole male connector provides easy replacement

Electrical

Voltage: 10 to 30V DC max.
 Amperage: Module—12.0A max.
 Port—4.0A max.

Physical

Housing: PBT
 Port Shell Material: Nickel-plated Brass
 Contacts: Copper alloy with Gold over Nickel plating
 Wiring Configuration: Dual I/O, M12 5-pole female port
 Home Run Cable: Black PUR cable, conductors:
 4-port—8 × 0.34mm² + 3 × 0.75 mm²
 6-port—12 × 0.34mm² + 3 × 0.75 mm²
 8-port—16 × 0.34mm² + 3 × 0.75 mm²

Environmental

Protection: IP67
 NEMA Rating: NEMA 6

Port Configuration	Box Configuration	Ports	LED Indicator	Cable Length	Top Mount	
					Engineering No.	Standard Order No.
		4	No	5.0m	BKY4120-FBP-01	120119-0008
		8	No	5.0m	BKY8120-FBP-01	120119-0025

Note: Sales drawings for all standard order numbers are available on molex.com

Configuration Code*
 Build-a-Part Number

	Length	Code
Meters	5	01
	10	10
	15	15

BKY4010-FBP-01

*Once an engineering number is created using the configuration code, consult Molex tech support for information regarding any part numbers.

Brad® Micro-Change® (M12) Connectors

EUROPE

Rugged Micro-Change® connectors provide a high-pin-density, M12 solution that is ideal for use in industrial and harsh commercial environments.

Brad Micro-Change products are Molex's offering of rugged, high-circuit density, industry-standard M12 circular connectors for industrial automation applications.

Micro-Change connectors are designed to withstand harsh industrial environments and their superior quality assures a very reliable connection for control elements in automated equipment. These IEC 61076-2-101-compliant connectors allow fast and simple connections to 12.00 and 18.00mm sensors, encoders, switches and other input and output devices in industrial machinery.

Brad's complete line of M12 connectivity provides a quick-connect wiring system that eliminates field-install cabinets and minimizes field wiring termination errors.

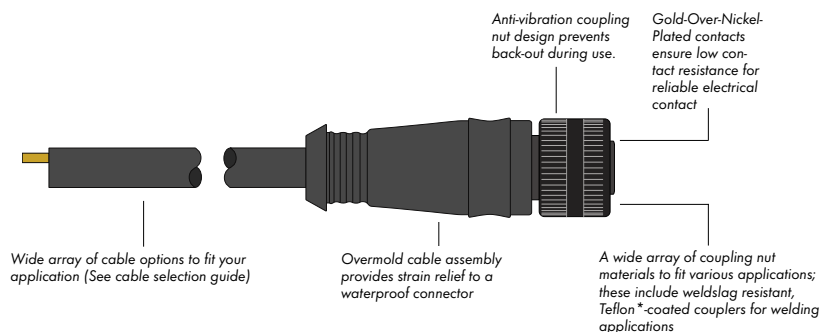

Features and Benefits

Cordsets

- Available in 3-, 4-, 5-, 8- and 12-poles; in single and dual-key configurations; with or without LEDs; in straight and 90°; and with different coupling nut materials to provide a wide variety of options to meet application requirements
- Intermates with industry standard M12 devices that comply with IEC 61076-2-101
- Rugged, IP68 rated watertight connector is well suited for harsh, wet environments
- Patented, anti-vibration feature prevents back-out in applications that experience high vibration and mechanical shock
- Gold-over-nickel-plated contacts provide a durable, corrosion-resistant plating that maintains low electrical resistance throughout the life of the connector

Receptacles, Field Attachables and Accessories

- Large selection of configurations to fit your panel or device design, including front- and back-panel-mount receptacles in a variety of materials, with PCB or wire leads
- Epoxy potted receptacles are IP67- and IP68-rated, and are ideal for rugged industrial environments

- 3- to 5-pole field-attachable connectors with screw-down terminals for easy field installation, allow users to make their own cable assemblies for a custom fit to a machine or application

Distribution Boxes

- Available in 4-, 6- and 8-port distribution boxes; single and dual I/O versions. These pre-wired junction boxes comprise the Molex quick-connect wiring system for I/O devices. They eliminate the need for field-installed junction boxes, providing improved wire management
- Fully potted housing ensures performance in high-vibration and wet environment applications
- Rugged and compact to allow placement in tight places

Applications

- Proximity switches, photo eyes, safety switches and other I/O connectivity
- Connector interface for IP69-rated devices
- Connectivity for devices in high-vibration environments
- Connections requiring blind-mating

Teflon® is a registered trademark of E.I. DuPont De Nemours and Company.

Brad® Micro-Change® (M12) A-Code Single-Ended Cordsets (Europe)

120006/120065

Female, Pigtail Straight, Right Angle



Features and Benefits

- M12 Single Keyway (A-Coding) IEC compliant cordset assemblies
- 3-, 4-, and 5-pole versions are interchangeable for added flexibility
- IP67/68 rated for harsh environments
- Patented anti-vibration feature to prevent loosening under high-vibration applications
- Wide selection of cables to fit applications
 - PVC cables for light, cost-sensitive industrial applications
 - PUR cables for moderate flexing and for environments encountering cutting fluids and oils
 - TPE cables for continuous-flex applications. Also ideal for welding cells; cable is weld slag resistant

Reference Information

UL File No.: E152210 (K05 cable assemblies)
 CSA File No.: LR6837 (K05 cable assemblies)

Physical

Connector Body: PUR (TPE for K05)
 Contact Carries: Polyamide
 O-ring: Viton® (EPDM for E03 cables)
 Coupling Nut: Nickel-plated Brass (Teflon® coated for K05)
 Contacts: Copper alloy with Gold over Nickel plating
 Cables: E03—Black PVC jacket, 0.34mm² PVC conductors, 300V, 80° C, UL AWM 2464
 P03—Black PUR/PVC jacket, 0.34mm² PVC conductors, 300V, 80° C
 H09—Black PUR jacket, 0.34mm² PVC conductors, 300V, 80° C, Low Smoke/Zero Halogen (LSOH), UL AWM 21198
 K05—Yellow TPE jacket, 22 AWG PVC conductors, 300V, UL PLTC-ER, +10M flex life (torsion and bending)

Environmental

Protection: IP67
 NEMA Rating: NEMA 6

Poles	Max. Current per Contact	Max. Voltage	Cable Type	Cable Jacket (Cable Code)	Wire Size	Length	Female Straight		Female Right Angle	
							Engineering No.	Standard Order No.	Engineering No.	Standard Order No.
3 Pole 1 - Brown 4 - Black 3 - Blue	4.0A	250V AC/DC	LSOH, UL 21198	PVC (E03)	0.34mm²	2.0m	803000E03M020	120006-0001	803001E03M020	120006-0007
				PUR/PVC (P03)			803000P03M020	120006-0004	803001P03M020	120006-0011
				PUR (H09)			803000H09M020	120065-8175	803001H09M020	120065-8715
				PLTC-ER TPE (K05)			803000K05M020	120065-1108	803001K05M020	120065-1489
4 Pole 1 - Brown 3 - Blue 2 - White 4 - Black	4.0A	250V AC/DC	LSOH, UL 21198	PVC (E03)	0.34mm²	2.0m	804000E03M020	120006-0014	804001E03M020	120006-0021
				PUR/PVC (P03)			804000P03M020	120006-0018	804001P03M020	120006-0024
				PUR (H09)			804000H09M020	120065-8178	804001H09M020	120065-8513
				PLTC-ER TPE (K05)			804000K05M020	120065-1121	804001K05M020	120065-1639
5 Pole 1 - Brown 4 - Black 2 - White 5 - Gray 3 - Blue	4.0A	250V AC/DC	LSOH, UL 21198	PVC (E03)	0.34mm²	2.0m	805000E03M020	120006-0634	805001E03M020	120006-0652
				PUR/PVC (P03)			805000P03M020	120006-0647	805001P03M020	120006-0663
				PUR (H09)			805000H09M020	120065-8172	805001H09M020	120065-8296

Note: Sales drawings for all standard order numbers are available on molex.com.
 Teflon® and Viton® are registered trademarks of E.I. DuPont De Nemours and Company.

Configuration Code*
 Build-a-Part Number

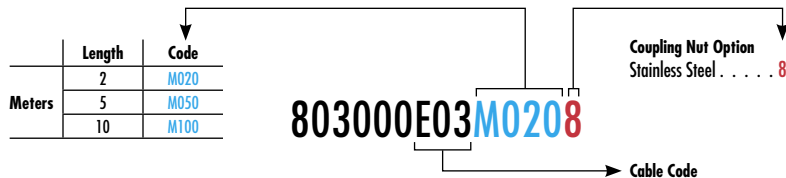

*Once an engineering number is created using the configuration code, consult Molex tech support for information regarding any part numbers.

Brad® Micro-Change® (M12) A-Code Single-Ended Cordsets (Europe)

120006/120065

Female, Pigtail
Straight, Right Angle



Features and Benefits

- M12 Single Keyway (A-Coding) IEC compliant cordset assemblies
- 3-, 4-, and 5-pole versions are intermatable for added flexibility
- IP67/68 rated for harsh environments
- Patented anti-vibration feature to prevent loosening under high-vibration applications
- Wide selection of cables to fit applications
 - PVC cables for light, cost-sensitive industrial applications
 - PUR cables for moderate flexing and for environments encountering cutting fluids and oils
 - TPE cables for continuous-flex applications. Also ideal for welding cells; cable is weld slag resistant

Reference Information

UL File No.: E152210
CSA File No.: LR6837

Physical

Connector Body: PUR
Contact Carries: Polyamide
O-ring: Viton®
Coupling Nut: Nickel-plated Brass
Contacts: Copper alloy with Gold over Nickel plating
Cables: P02—Black PUR/PVC jacket, 0.25mm² PVC conductors, 300V, 80° C
H08—Black PUR jacket, 0.25mm² PVC conductors, 300V, 80° C, Low Smoke/Zero Halogen (LSOH), UL AWM 21198
H45—Black PUR jacket, 26 AWG PVC conductors, 300V, 80° C, UL AWM 20549

Environmental

Protection: IP67
NEMA Rating: NEMA 6

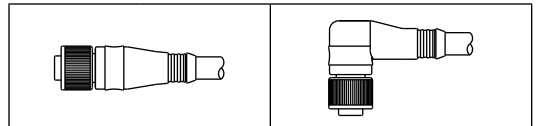

Poles (Female View)	Max. Current per Contact	Max. Voltage	Cable Type	Cable Jacket (Cable Code)	Wire Size	Length	Female Straight		Female Right Angle	
							Engineering No.	Standard Order No.	Engineering No.	Standard Order No.
8 Pole 1 - White 5 - Gray 2 - Brown 6 - Pink 3 - Green 7 - Blue 4 - Yellow 8 - Red	2.0A	30V AC/36V DC	LSOH, UL 21198	PUR/PVC (P02)	0.25mm²	2.0m	808000P02M020	120065-0951	808001P02M020	120065-0960
				PUR (H08)			808000H08M020	120065-8644	808001H08M020	120065-8649
12 Pole 1-White 5-Gray 9-Black 2-Brown 6-Pink 10-Violet 3-Green 7-Blue 11-Gray-Pink 4-Yellow 8-Red 12-Red-Blue	1.5A	30V AC/DC	UL 20549	PUR (H45)	26 AWG	2.0m	80C000H45M020	120065-5040	80C001H45M020	120065-5099

Note: Sales drawings for all standard order numbers are available on molex.com.
Viton® is a registered trademark of E.I. DuPont De Nemours and Company.

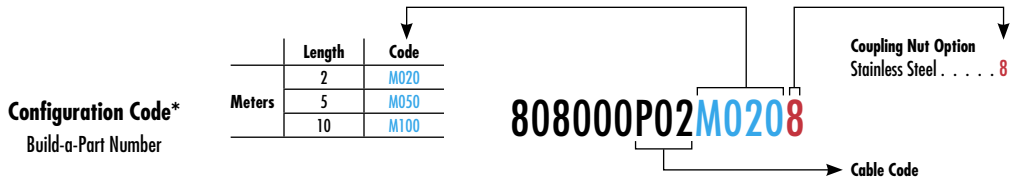

*Once an engineering number is created using the configuration code, consult Molex tech support for information regarding any part numbers.

Brad® Micro-Change® (M12) A-Code Single-Ended Cordsets (Europe)

120006/120065

Male, Pigtail
Straight, Right Angle



Features and Benefits

- M12 Single Keyway (A-Coding) IEC compliant cordset assemblies
- 3-, 4-, and 5-pole versions are intermatable for added flexibility
- IP67/68 rated for harsh environments
- Patented anti-vibration feature to prevent loosening under high-vibration applications
- Wide selection of cables to fit applications
 - PVC cables for light, cost-sensitive industrial applications
 - PUR cables for moderate flexing and for environments encountering cutting fluids and oils
 - TPE cables for continuous-flex applications. Also ideal for welding cells; cable is weld slag resistant

Reference Information

UL File No.: E152210 (K05 cable assemblies)
CSA File No.: LR6837 (K05 cable assemblies)

Physical

Connector Body: PUR (TPE for K05)
Contact Carries: Polyamide
Coupling Nut: Nickel-plated Brass (Teflon® coated for K05)
Contacts: Copper alloy with Gold over Nickel plating
Cables: E03—Black PVC jacket, 0.34mm² PVC conductors, 300V, 80° C, UL AWM 2464
P03—Black PUR/PVC jacket, 0.34mm² PVC conductors, 300V, 80° C
H09—Black PUR jacket, 0.34mm² PVC conductors, 300V, 80° C, Low Smoke/Zero Halogen (LSOH), UL AWM 21198
K05—Yellow TPE jacket, 22 AWG PVC conductors, 300V, UL PLTC-ER, +10M flex life (torsion and bending)

Environmental

Protection: IP67
NEMA Rating: NEMA 6

Poles (Male View)	Max. Current per Contact	Max. Voltage	Cable Type	Cable Jacket (Cable Code)	Wire Size	Length	Male Straight		Male Right Angle	
							Engineering No.	Standard Order No.	Engineering No.	Standard Order No.
3 Pole 1 - Brown 4 - Black 3 - Blue	4.0A	250V AC/DC	UL 2464	PVC (E03)	0.34mm ²	2.0m	803006E03M020	120006-0240	803007E03M020	120006-0273
				PUR/PVC (P03)			803006P03M020	120006-0257	803007P03M020	120006-0288
			LSOH, UL 21198	PUR (H09)			803006H09M020	120065-8655	803007H09M020	120065-8722
			PLTC-ER	TPE (K05)			803006K05M020	120065-1114	803007K05M020	120065-1501
4 Pole 1 - Brown 3 - Blue 2 - White 4 - Black	4.0A	250V AC/DC	UL 2464	PVC (E03)	0.34mm ²	2.0m	804006E03M020	120006-0560	804007E03M020	120006-1975
				PUR/PVC (P03)			804006P03M020	120006-0570	804007P03M020	120006-0592
			LSOH, UL 21198	PUR (H09)			804006H09M020	120065-8729	804007H09M020	120065-8736
			PLTC-ER	TPE (K05)			804006K05M020	120065-1129	804007K05M020	120065-1691
5 Pole 1 - Brown 4 - Black 2 - White 5 - Gray 3 - Blue	4.0A	250V AC/DC	UL 2464	PVC (E03)	0.34mm ²	2.0m	805006E03M020	120006-0667	805007E03M020	120065-8096
				PUR/PVC (P03)			805006P03M020	120006-0680	805007P03M020	120006-0697
			LSOH, UL 21198	PUR (H09)			805006H09M020	120065-8743	805007H09M020	120065-8750

Note: Sales drawings for all standard order numbers are available on molex.com.
Teflon® is a registered trademark of E.I. DuPont De Nemours and Company.

Configuration Code*
Build-a-Part Number

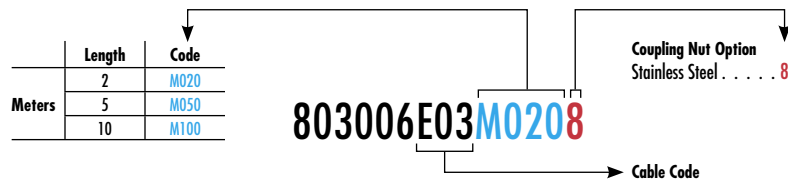

*Once an engineering number is created using the configuration code, consult Molex tech support for information regarding any part numbers.

Brad® Micro-Change® (M12) A-Code Single-Ended Cordsets (Europe)

120006/120065

Male, Pigtail
Straight, Right Angle



Features and Benefits

- M12 Single Keyway (A-Coding) IEC compliant cordset assemblies
- 3-, 4-, and 5-pole versions are intermatable for added flexibility
- IP67/68 rated for harsh environments
- Patented anti-vibration feature to prevent loosening under high-vibration applications
- Wide selection of cables to fit applications
 - PVC cables for light, cost-sensitive industrial applications
 - PUR cables for moderate flexing and for environments encountering cutting fluids and oils
 - TPE cables for continuous-flex applications. Also ideal for welding cells; cable is weld slag resistant

Physical

Connector Body: PUR
 Contact Carries: Polyamide
 Contacts: Copper alloy with Gold over Nickel plating
 Cables: P02—Black PUR/PVC jacket, 0.25mm² PVC conductors, 300V, 80° C
 H08—Black PUR jacket, 0.25mm² PVC conductors, 300V, 80° C, Low Smoke/Zero Halogen (LSOH), UL AWM 21198
 H45—Black PUR jacket, 26 AWG PVC conductors, 300V, 80° C, UL AWM 20549

Environmental

Protection: IP67
 NEMA Rating: NEMA 6

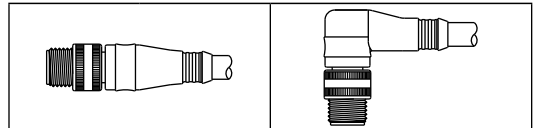

Poles (Male View)	Max. Current per Contact	Max. Voltage	Cable Type	Cable Jacket (Cable Code)	Wire Size	Length	Male Straight		Male Right Angle		
							Engineering No.	Standard Order No.	Engineering No.	Standard Order No.	
8 Pole 1 - White 5 - Gray 2 - Brown 6 - Pink 3 - Green 7 - Blue 4 - Yellow 8 - Red	2.0A	30V AC/36V DC	PUR/PVC (P02)	LSOH, UL 21198	PUR (H08)	0.25mm ²	2.0m	808006P02M020	120065-0964	808007P02M020	120065-1800
808006H08M020			120065-8660					808007H08M020	120065-8757		
12 Pole 1-White 5-Gray 9-Black 2-Brown 6-Pink 10-Violet 3-Green 7-Blue 11-Gray-Pink 4-Yellow 8-Red 12-Red-Blue	1.5A	30V AC/DC	UL 20549	PUR (H45)	26 AWG	2.0m	80C006H45M020	120065-5045	80C007H45M020	120065-5109	

Note: Sales drawings for all standard order numbers are available on molex.com

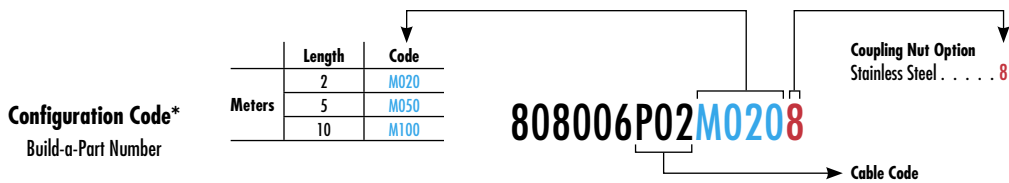

*Once an engineering number is created using the configuration code, consult Molex tech support for information regarding any part numbers.

Brad® Micro-Change® (M12) A-Code Double-Ended Cordsets (Europe)

120006/120007/120066

Female Straight-to-Male Straight,
Female Right Angle-to-Male Straight



Features and Benefits

- M12 Single Keyway (A-Coding) IEC compliant cordset assemblies
- 3-, 4-, and 5-pole versions are interchangeable for added flexibility
- IP67/68 rated for harsh environments
- Patented anti-vibration feature to prevent loosening under high-vibration applications
- Wide selection of cables to fit applications
 - PVC cables for light, cost-sensitive industrial applications
 - PUR cables for moderate flexing and for environments encountering cutting fluids and oils
 - TPE cables for continuous-flex applications. Also ideal for welding cells; cable is weld slag resistant

Reference Information

UL File No.: E152210 (K05 cable assemblies)
CSA File No.: LR6837 (K05 cable assemblies)

Physical

Connector Body: PUR (TPE for K05)
Contact Carries: Polyamide
O-ring: Viton® (EPDM for E03 cables)
Coupling Nut: Nickel-plated Brass (Teflon® coated for K05)
Contacts: Copper alloy with Gold over Nickel plating
Cables: E03—Black PVC jacket, 0.34mm² PVC conductors, 300V, 80° C, UL AWM 2464
P03—Black PUR/PVC jacket, 0.34mm² PVC conductors, 300V, 80° C
H09—Black PUR jacket, 0.34mm² PVC conductors, 300V, 80° C, Low Smoke/Zero Halogen (LSOH), UL AWM 21198
K05—Yellow TPE jacket, 22 AWG PVC conductors, 300V, UL PLTC-ER, +10M flex life (torsion and bending)

Environmental

Protection: IP67
NEMA Rating: NEMA 6

Poles (Female View)	Max. Current per Contact	Max. Voltage	Cable Type	Cable Jacket (Cable Code)	Wire Size	Length	Female Straight-to-Male Straight		Female Right Angle-to-Male Straight	
							Engineering No.	Standard Order No.	Engineering No.	Standard Order No.
3 Pole 1 - Brown 4 - Black 3 - Blue	4.0A	250V AC/DC	UL 2464	PVC (E03)	0.34mm ²	1.0m	883030E03M010	120007-0083	883031E03M010	120007-0119
				PUR/PVC (P03)			883030P03M010	120066-0498	883031P03M010	120007-0142
			LSOH, UL 21198	PUR (H09)			883030H09M010	120066-8374	883031H09M010	120065-8763
			PLTC-ER	TPE (K05)			883030K05M010	120066-0676	883031K05M010	120066-0222
4 Pole 1 - Brown 3 - Blue 2 - White 4 - Black	4.0A	250V AC/DC	UL 2464	PVC (E03)	0.34mm ²	1.0m	884030E03M010	120007-0473	884031E03M010	120007-0509
				PUR/PVC (P03)			884030P03M010	120007-0488	884031P03M010	120006-0056
			LSOH, UL 21198	PUR (H09)			884030H09M010	120066-8379	884031H09M010	120066-8484
			PLTC-ER	TPE (K05)			884030K05M010	120066-0687	884031K05M010	120066-0376
5 Pole 1 - Brown 4 - Black 2 - White 5 - Gray 3 - Blue	4.0A	250V AC/DC	UL 2464	PVC (E03)	0.34mm ²	1.0m	885030E03M010	120007-0906	885031E03M010	120066-8189
				PUR/PVC (P03)			885030P03M010	120066-8084	885031P03M010	120066-8188
			LSOH, UL 21198	PUR (H09)			885030H09M010	120066-8497	885031H09M010	120066-8496

Note: Sales drawings for all standard order numbers are available on molex.com.
Teflon® and Viton® are registered trademarks of E.I. DuPont De Nemours and Company.

Configuration Code*
Build-a-Part Number

Length	Code
0.3	M003
0.6	M006
1	M010
2	M020
3	M030
4	M040
5	M050

Meters

883030E03M0108

Cable Code

Coupling Nut Option
Stainless Steel 8

*Once an engineering number is created using the configuration code, consult Molex tech support for information regarding any part numbers.

Brad® Micro-Change® (M12) A-Code Double-Ended Cordsets (Europe)

120006/120007/120066

Female Straight-to-Male Straight, Female Right Angle-to-Male Straight



Features and Benefits

- M12 Single Keyway (A-Coding) IEC compliant cordset assemblies
- 3-, 4-, and 5-pole versions are intermable for added flexibility
- IP67/68 rated for harsh environments
- Patented anti-vibration feature to prevent loosening under high-vibration applications
- Wide selection of cables to fit applications
 - PVC cables for light, cost-sensitive industrial applications
 - PUR cables for moderate flexing and for environments encountering cutting fluids and oils
 - TPE cables for continuous-flex applications. Also ideal for welding cells; cable is weld slag resistant

Physical

Connector Body: PUR (TPE for K05)
 Contact Carries: Polyamide
 O-ring: Viton®
 Coupling Nut: Nickel-plated Brass
 Contacts: Copper alloy with Gold over Nickel plating
 Cables: P02—Black PUR/PVC jacket, 0.25mm² PVC conductors, 300V, 80° C
 H08—Black PUR jacket, 0.25mm² PVC conductors, 300V, 80° C, Low Smoke/Zero Halogen (LSOH), UL AWM 21198
 H45—Black PUR jacket, 26 AWG PVC conductors, 300V, 80° C, UL AWM 20549

Environmental

Protection: IP67
 NEMA Rating: NEMA 6

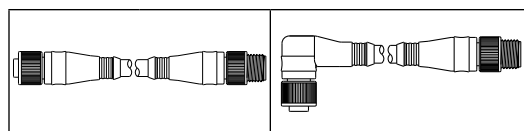

Poles (Female View)	Max. Current per Contact	Max. Voltage	Cable Type	Cable Jacket (Cable Code)	Wire Size	Length	Female Straight-to-Male Straight		Female Right Angle-to-Male Straight	
							Engineering No.	Standard Order No.	Engineering No.	Standard Order No.
8 Pole 1 - White 5 - Gray 2 - Brown 6 - Pink 3 - Green 7 - Blue 4 - Yellow 8 - Red	2.0A	30V AC/36V DC	PUR/PVC (P02)	0.25mm²	1.0m	888030P02M010	120066-0579	888031P02M010	120066-1626	
			LSOH, UL 21198			PUR (H08)	888030H08M010	120066-8491	888031H08M010	120065-8909
12 Pole 1-White 5-Gray 9-Black 2-Brown 6-Pink 10-Violet 3-Green 7-Blue 11-Gray-Pink 4-Yellow 8-Red 12-Red-Blue	1.5A	30V AC/DC	UL 20549	PUR (H45)	26 AWG	1.0m	88C030H45M010	120066-5404	88C031H45M010	120066-5405

Note: Sales drawings for all standard order numbers are available on molex.com.
 Viton® is a registered trademark of E.I. DuPont De Nemours and Company.

Configuration Code*
 Build-a-Part Number

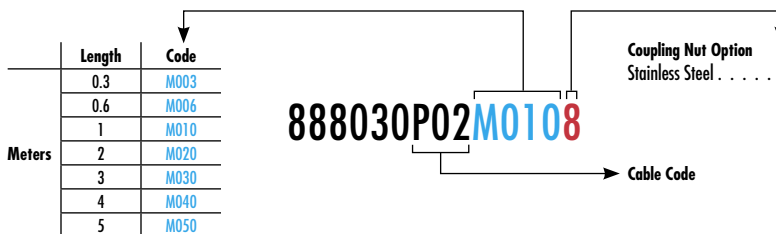

*Once an engineering number is created using the configuration code, consult Molex tech support for information regarding any part numbers.

Brad® Micro-Change® (M12) A-Code Double-Ended Cordsets (Europe)

120007/120066

Female Straight-to-Male Right Angle, Female Right Angle-to-Male Right Angle



Features and Benefits

- M12 Single Keyway (A-Coding) IEC compliant cordset assemblies
- 3-, 4-, and 5-pole versions are interchangeable for added flexibility
- IP67/68 rated for harsh environments
- Patented anti-vibration feature to prevent loosening under high-vibration applications
- Wide selection of cables to fit applications
 - PVC cables for light, cost-sensitive industrial applications
 - PUR cables for moderate flexing and for environments encountering cutting fluids and oils
 - TPE cables for continuous-flex applications. Also ideal for welding cells; cable is weld slag resistant

Reference Information

UL File No.: E152210 (K05 cable assemblies)
CSA File No.: LR6837 (K05 cable assemblies)

Physical

Connector Body: PUR (TPE for K05)
Contact Carries: Polyamide
O-ring: Viton® (EPDM for E03 cables)
Coupling Nut: Nickel-plated Brass (Teflon® coated for K05)
Contacts: Copper alloy with Gold over Nickel plating
Cables: E03—Black PVC jacket, 0.34mm² PVC conductors, 300V, 80° C, UL AWM 2464
P03—Black PUR/PVC jacket, 0.34mm² PVC conductors, 300V, 80° C
H09—Black PUR jacket, 0.34mm² PVC conductors, 300V, 80° C, Low Smoke/Zero Halogen (LSOH), UL AWM 21198
K05—Yellow TPE jacket, 22 AWG PVC conductors, 300V, UL PLTC-ER, +10M flex life (torsion and bending)

Environmental

Protection: IP67
NEMA Rating: NEMA 6

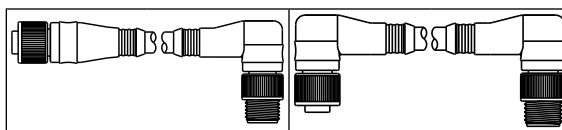

Poles (Female View)	Max. Current per Contact	Max. Voltage	Cable Type	Cable Jacket (Cable Code)	Wire Size	Length	Female Straight-to-Male Right Angle		Female Right Angle-to-Male Right Angle	
							Engineering No.	Standard Order No.	Engineering No.	Standard Order No.
3 Pole 1 - Brown 4 - Black 3 - Blue	4.0A	250V AC/DC	UL 2464	PVC (E03)	0.34mm ²	1.0m	883032E03M010	120007-0160	883033E03M010	120066-5399
				PUR/PVC (P03)			883032P03M010	120007-0172	883033P03M010	120007-0216
			LSOH, UL 21198	PUR (H09)			883032H09M010	120007-2879	883033H09M010	120066-8498
				PLTC-ER			TPE (K05)	883032K05M010	120066-0231	883033K05M010
4 Pole 1 - Brown 3 - Blue 2 - White 4 - Black	4.0A	250V AC/DC	UL 2464	PVC (E03)	0.34mm ²	1.0m	884032E03M010	120066-8073	884033E03M010	120007-0554
				PUR/PVC (P03)			884032P03M010	120007-1407	884033P03M010	120007-1523
			LSOH, UL 21198	PUR (H09)			884032H09M010	120066-8494	884033H09M010	120066-8492
				PLTC-ER			TPE (K05)	884032K05M010	120066-0400	884033K05M010
5 Pole 1 - Brown 4 - Black 2 - White 5 - Gray 3 - Blue	4.0A	250V AC/DC	UL 2464	PVC (E03)	0.34mm ²	1.0m	885032E03M010	120007-1271	885033E03M010	120066-5402
				PUR/PVC (P03)			885032P03M010	120066-5401	885033P03M010	120066-8094
			LSOH, UL 21198	PUR (H09)			885032H09M010	120066-8493	885033H09M010	120066-8499

Note: Sales drawings for all standard order numbers are available on molex.com.

Teflon® and Viton® are registered trademarks of E.I. DuPont De Nemours and Company.

Configuration Code*
Build-a-Part Number



*Once an engineering number is created using the configuration code, consult Molex tech support for information regarding any part numbers.

Brad® Micro-Change® (M12) A-Code Double-Ended Cordsets (Europe)

120007/120066

Female Straight-to-Male Right Angle, Female Right Angle-to-Male Right Angle



Features and Benefits

- M12 Single Keyway (A-Coding) IEC compliant cordset assemblies
- 3-, 4-, and 5-pole versions are intermatable for added flexibility
- IP67/68 rated for harsh environments
- Patented anti-vibration feature to prevent loosening under high-vibration applications
- Wide selection of cables to fit applications
 - PVC cables for light, cost-sensitive industrial applications
 - PUR cables for moderate flexing and for environments encountering cutting fluids and oils
 - TPE cables for continuous-flex applications. Also ideal for welding cells; cable is weld slag resistant

Physical

Connector Body: PUR
 Contact Carries: Polyamide
 O-ring: Viton®
 Coupling Nut: Nickel-plated Brass
 Contacts: Copper alloy with Gold over Nickel plating
 Cables: P02—Black PUR/PVC jacket, 0.25mm² PVC conductors, 300V, 80° C
 H08—Black PUR jacket, 0.25mm² PVC conductors, 300V, 80° C, Low Smoke/Zero Halogen (LSOH), UL AWM 21198
 H45—Black PUR jacket, 26 AWG PVC conductors, 300V, 80° C, UL AWM 20549

Environmental

Protection: IP67
 NEMA Rating: NEMA 6

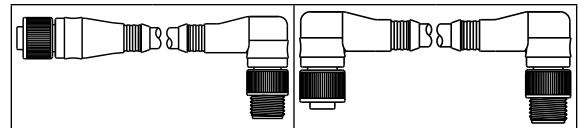

Poles (Female View)	Max. Current per Contact	Max. Voltage	Cable Type	Cable Jacket (Cable Code)	Wire Size	Length	Female Straight-to-Male Right Angle		Female Right Angle-to-Male Right Angle	
							Engineering No.	Standard Order No.	Engineering No.	Standard Order No.
8 Pole 1 - White 5 - Gray 2 - Brown 6 - Pink 3 - Green 7 - Blue 4 - Yellow 8 - Red	2.0A	30V AC/36V DC		PUR/PVC (P02)	0.25mm²	1.0m	888032P02M010	120066-5403	888033P02M010	120066-0479
			LSOH, UL 21198	PUR (H08)			888032H08M010	120066-8495	888033H08M010	120065-8908
12 Pole 1-White 5-Gray 9-Black 2-Brown 6-Pink 10-Violet 3-Green 7-Blue 11-Gray-Pink 4-Yellow 8-Red 12-Red-Blue	1.5A	30V AC/DC	UL 20549	PUR (H45)	26 AWG	1.0m	88C032H45M010	120066-5406	88C033H45M010	120066-5407

Note: Sales drawings for all standard order numbers are available on molex.com.
 Viton® is a registered trademark of E.I. DuPont De Nemours and Company.

Configuration Code*
 Build-a-Part Number

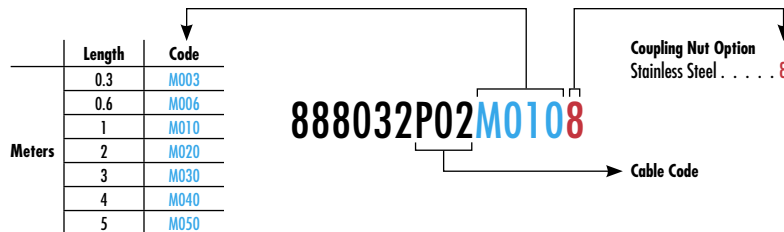

*Once an engineering number is created using the configuration code, consult Molex tech support for information regarding any part numbers.

Brad® Micro-Change® (M12) A-Code Single-Ended Cordsets (Europe)

120006/120067

Female, Pigtail Straight, Right Angle With LEDs



Features and Benefits

- M12 single keyway (A-Coding) IEC compliant cordset assemblies
- LEDs for power and signal trigger indicator for PNP sensors (for NPN sensors also available)
- IP67/68 rated for harsh environments
- Patented anti-vibration feature to prevent loosening under high-vibration applications
- Wide selection of cables to fit applications
 - PVC cables for light, cost-sensitive industrial applications
 - PUR cables for moderate flexing and for environments encountering cutting fluids and oils
 - TPE cables for continuous-flex applications. Also ideal for welding cells; cable is weld slag resistant

Reference Information

UL File No.: E152210 (K05 cable assemblies)
CSA File No.: LR6837 (K05 cable assemblies)

Physical

Connector Body: PUR (TPE for K05)
Contact Carries: Polyamide
O-ring: Viton®
Coupling Nut: Nickel-plated Brass (Teflon® coated for K05)
Contacts: Copper alloy with Gold over Nickel plating
LEDs: Green—Power
Yellow—Sensor/output trigger
Cables: E03—Black PVC jacket, 0.34mm² PVC conductors, 300V, 80° C, UL AWM 2464
P03—Black PUR/PVC jacket, 0.34mm² PVC conductors, 300V, 80° C
H09—Black PUR jacket, 0.34mm² PVC conductors, 300V, 80° C, Low Smoke/Zero Halogen (LSOH), UL AWM 21198
K05—Yellow TPE jacket, 22 AWG PVC conductors, 300V, UL PLTC-ER, +10M flex life (torsion and bending)

Environmental

Protection: IP67
NEMA Rating: NEMA 6

Poles	Max. Current per Contact	Max. Voltage	Cable Type	Cable Jacket (Cable Code)	Wire Size	Length	Female Straight		Female Right Angle	
							Engineering No.	Standard Order No.	Engineering No.	Standard Order No.
<p>3-Pole/1 LED</p> <p>1 - Brown 4 - Black 3 - Blue</p>	4.0A	250V AC/DC	UL 2464	PVC (E03)	0.34mm²	2.0m	8030PE03M020	120067-5227	8030P1E03M020	120067-5067
				PUR/PVC (P03)			8030PP03M020	120067-5008	8030P1P03M020	120067-5069
			LSOH, UL 21198	PUR (H09)			8030PH09M020	120067-8328	8030P1H09M020	120067-8308
			PLTC-ER	TPE (K05)			8030PK05M020	120067-5228	8030P1K05M020	120067-0198
<p>4-Pole/1 LED</p> <p>1 - Brown 3 - Blue 2 - White 4 - Black</p>	4.0A	250V AC/DC	UL 2464	PVC (E03)	0.34mm²	2.0m	8040PE03M020	120067-5094	8040P1E03M020	120067-5014
				PUR/PVC (P03)			8040PP03M020	120067-5063	8040P1P03M020	120006-0618
			LSOH, UL 21198	PUR (H09)			8040PH09M020	120067-8327	8040P1H09M020	120067-8309
			PLTC-ER	TPE (K05)			8040PK05M020	120067-5230	8040P1K05M020	120067-5232

Note: Sales drawings for all standard order numbers are available on molex.com.
Teflon® and Viton® are registered trademarks of E.I. DuPont De Nemours and Company.

Configuration Code*
Build-a-Part Number



*Once an engineering number is created using the configuration code, consult Molex tech support for information regarding any part numbers.

Brad® Micro-Change® (M12) A-Code Double-Ended Cordsets (Europe)

120067

Female Straight-to-Male Straight, Female Right Angle-to-Male Straight



Features and Benefits

- M12 single keyway (A-Coding) IEC compliant cordset assemblies
- LEDs for power and signal trigger indicator for PNP sensors (for NPN sensors also available)
- IP67/68 rated for harsh environments
- Patented anti-vibration feature to prevent loosening under high-vibration applications
- Wide selection of cables to fit applications
 - PVC cables for light, cost-sensitive industrial applications
 - PUR cables for moderate flexing and for environments encountering cutting fluids and oils
 - TPE cables for continuous-flex applications. Also ideal for welding cells; cable is weld slag resistant

Reference Information

UL File No.: E152210 (K05 cable assemblies)
CSA File No.: LR6837 (K05 cable assemblies)

Physical

Connector Body: PUR (TPE for K05)
Contact Carries: Polyamide
O-ring: Viton®
Coupling Nut: Nickel-plated Brass (Teflon® coated for K05)
Contacts: Copper alloy with Gold over Nickel plating
LEDs: Green—Power
Yellow—Sensor/output trigger
Cables: E03—Black PVC jacket, 0.34mm² PVC conductors, 300V, 80° C, UL AWM 2464
P03—Black PUR/PVC jacket, 0.34mm² PVC conductors, 300V, 80° C
H09—Black PUR jacket, 0.34mm² PVC conductors, 300V, 80° C, Low Smoke/Zero Halogen (LSOH), UL AWM 21198
K05—Yellow TPE jacket, 22 AWG PVC conductors, 300V, UL PLTC-ER, +10M flex life (torsion and bending)

Environmental

Protection: IP67
NEMA Rating: NEMA 6

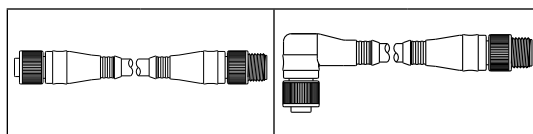

Poles (Female View)	Max. Current per Contact	Max. Voltage	Cable Type	Cable Jacket (Cable Code)	Wire Size	Length	Female Straight-to-Male Straight		Female Right Angle-to-Male Straight			
							Engineering No.	Standard Order No.	Engineering No.	Standard Order No.		
3-Pole/1 LED 1 - Brown 3 - Blue 4 - Black	4.0A	250V AC/DC	UL 2464	PVC (E03)	0.34mm²	1.0m	8830P6E03M010	120067-8064	8830P7E03M010	120067-8068		
				PUR/PVC (P03)					8830P7P03M010	120067-5078		
			LSOH, UL 21198	PUR (H09)			8830P6H09M010	120067-8331	8830P7H09M010	120067-8295		
			PLTC-ER	TPE (K05)			8830P6K05M010	120067-0040	8830P7K05M010	120067-0065		
4-Pole/1 LED 1 - Brown 2 - White 3 - Blue 4 - Black	4.0A	250V AC/DC	UL 2464	PVC (E03)	0.34mm²	1.0m	8840P6E03M010	120067-5241	8840P7E03M010	120067-5090		
				PUR/PVC (P03)					8840P6P03M010	120067-8255	8840P7P03M010	120067-5040
			LSOH, UL 21198	PUR (H09)			8840P6H09M010	120067-8333	8840P7H09M010	120067-8332		
			PLTC-ER	TPE (K05)			8840P6K05M010	120067-0101	8840P7K05M010	120067-0117		

Note: Sales drawings for all standard order numbers are available on molex.com.
Teflon® and Viton® are registered trademarks of E.I. DuPont De Nemours and Company.

Configuration Code*
Build-a-Part Number

Length	Code
0.3	M003
0.6	M006
1	M010
2	M020
3	M030
4	M040
5	M050

8830P6E03M0108

Coupling Nut Option
Stainless Steel 8

Cable Code

*Once an engineering number is created using the configuration code, consult Molex tech support for information regarding any part numbers.

Brad® Micro-Change® (M12) A-Code Double-Ended Cordsets (Europe)

120067

Female Straight-to-Male Right Angle with LEDs, Female Right Angle-to-Male Right Angle with LEDs



Features and Benefits

- M12 single keyway (A-Coding) IEC compliant cordset assemblies
- LEDs for power and signal trigger indicator for PNP sensors (for NPN sensors also available)
- IP67/68 rated for harsh environments
- Patented anti-vibration feature to prevent loosening under high-vibration applications
- Wide selection of cables to fit applications
 - PVC cables for light, cost-sensitive industrial applications
 - PUR cables for moderate flexing and for environments encountering cutting fluids and oils
 - TPE cables for continuous-flex applications. Also ideal for welding cells; cable is weld slag resistant

Reference Information

UL File No.: E152210 (K05 cable assemblies)
CSA File No.: LR6837 (K05 cable assemblies)

Physical

Connector Body: PUR (TPE for K05)
Contact Carries: Polyamide
O-ring: Viton®
Coupling Nut: Nickel-plated Brass (Teflon® coated for K05)
Contacts: Copper alloy with Gold over Nickel plating
LEDs: Green—Power
Yellow—Sensor/output trigger
Cables: E03—Black PVC jacket, 0.34mm² PVC conductors, 300V, 80° C, UL AWM 2464
P03—Black PUR/PVC jacket, 0.34mm² PVC conductors, 300V, 80° C
H09—Black PUR jacket, 0.34mm² PVC conductors, 300V, 80° C, Low Smoke/Zero Halogen (LSOH), UL AWM 21198
K05—Yellow TPE jacket, 22 AWG PVC conductors, 300V, UL PLTC-ER, +10M flex life (torsion and bending)

Environmental

Protection: IP67
NEMA Rating: NEMA 6

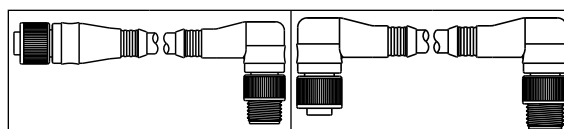

Poles (Female View)	Max. Current per Contact	Max. Voltage	Cable Type	Cable Jacket (Cable Code)	Wire Size	Length	Female Straight-to-Male Right Angle		Female Right Angle-to-Male Right Angle	
							Engineering No.	Standard Order No.	Engineering No.	Standard Order No.
3-Pole/1 LED 1 - Brown 4 - Black 3 - Blue	4.0A	250V AC/DC	UL 2464	PVC (E03)	0.34mm²	1.0m	8830P8E03M010	120067-5237	8830P9E03M010	120067-5088
				PUR/PVC (P03)			8830P8P03M010	120067-5238	8830P9P03M010	120067-8087
			LSOH, UL 21198	PUR (H09)			8830P8H09M010	120067-8334	8830P9H09M010	120067-8329
			PLTC-ER	TPE (K05)			8830P8K05M010	120067-0072	8830P9K05M010	120067-0079
4-Pole/1 LED 1 - Brown 3 - Blue 2 - White 4 - Black	4.0A	250V AC/DC	UL 2464	PVC (E03)	0.34mm²	1.0m	8840P8E03M010	120067-5244	8840P9E03M010	120067-5248
				PUR/PVC (P03)			8840P8P03M010	120067-5245	8840P9P03M010	120067-8211
			LSOH, UL 21198	PUR (H09)			8840P8H09M010	120067-8335	8840P9H09M010	120067-8330
			PLTC-ER	TPE (K05)			8840P8K05M010	120067-0122	8840P9K05M010	120067-5249

Note: Sales drawings for all standard order numbers are available on molex.com.
Teflon® and Viton® are registered trademarks of E.I. DuPont De Nemours and Company.

Configuration Code*
Build-a-Part Number



*Once an engineering number is created using the configuration code, consult Molex tech support for information regarding any part numbers.

Brad® Micro-Change® (M12) A-Code Receptacles (Europe)

120070/120011

Female
Front Panel Mount,
Back Panel Mount



Features and Benefits

- M12 single keyway (A-Coding) IEC compliant panel mount receptacles
- Available in 3-, 4-, 5- and 8-pole configurations
- Fully potted assemblies provide IP67/68 protection for harsh environments
- Available in an array of configurations to fit your needs:
 - Various mounting thread sizes, including pipe threads for direct mounting on pipe fittings
 - Front panel mounts for installing from the outside of the enclosure
 - Back panel mount from inside the enclosure
 - Wire leads for terminating to terminal strips or PCB tails to incorporate with electronics

Physical

Shell Material: Nickel-plated Brass
 Contact Carries: Polyamide
 O-Ring: M12—Red Viton®
 Panel—Black Viton
 Contacts: Copper alloy with Gold over Nickel plating
 Wire PVC Insulation: 300V, 80° C, UL1061,
 0.34mm² (3- to 5-poles) and
 0.25mm² (8-poles)

Environmental

Protection: IP67
 NEMA Rating: NEMA 6

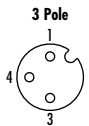
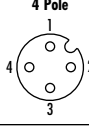
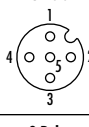
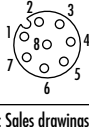
Poles	Max. Current per Contact	Max. Voltage	Configuration		Engineering No.		Standard Order No.			
			Wire Type	Wire Size	Length	Engineering No.	Standard Order No.	Engineering No.	Standard Order No.	
3 Pole 	4.0A	250V AC/DC	PG9, Front Panel Mount	PVC leads, UL1061	0.34mm ² /0.25mm ²	0.3m	8R3J20E03C3003	120070-5201	8R3J400013	120070-5203
4 Pole 	4.0A	250V AC/DC	PG9, Back Panel Mount	PCB Pins			8R4J20E03C3003	120070-5205	8R4J400013	120011-0237
5 Pole 	4.0A	250V AC/DC					8R5J20E03C3003	120070-5207	8R5J400013	120011-0238
8 Pole 	2.0A	30V AC / 36V DC					8R8J20E02C3003	120070-5208	8R8J400013	120070-5210

Note: Sales drawings for all standard order numbers are available on molex.com.
 Viton® is a registered trademark of E.I. DuPont De Nemours and Company.

Configuration Code*
Build-a-Part Number

	Length	Code
Meters	0.3	C300
	1.0	M010

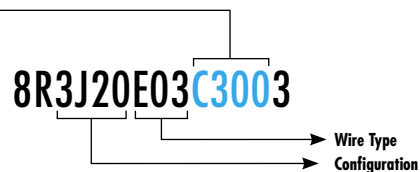

*Once an engineering number is created using the configuration code, consult Molex tech support for information regarding any part numbers.

Brad® Micro-Change® (M12) A-Code Receptacles (Europe)

120070/120011

Male

Front Panel Mount,
Back Panel Mount



Features and Benefits

- M12 single keyway (A-Coding) IEC compliant panel mount receptacles
- Available in 3-, 4-, 5- and 8-pole configurations
- Fully potted assemblies provide IP67/68 protection for harsh environments
- Available in an array of configurations to fit your needs:
 - Various mounting thread sizes, including pipe threads for direct mounting on pipe fittings
 - Front panel mounts for installing from the outside of the enclosure
 - Back panel mount from inside the enclosure
 - Wire leads for terminating to terminal strips or PCB tails to incorporate with electronics

Physical

Shell Material: Nickel-plated Brass
 Contact Carries: Polyamide
 O-Ring: Panel—Black Viton®
 Contacts: Copper alloy with Gold over Nickel plating
 Wire PVC Insulation: 300V, 80° C, UL1061,
 0.34mm² (3- to 5-poles) and
 0.25mm² (8-poles)

Environmental

Protection: IP67
 NEMA Rating: NEMA 6

Configuration	PG9, Front Panel Mount		PG9, Back Panel Mount	
	Wire Type		PCB Pins	
	Wire Size			
	Length			
	PG9, Front Panel Mount	PVC leads, UL1061		
		0.34mm ² /0.25mm ²		
		0.3m		

Poles	Max. Current per Contact	Max. Voltage	Engineering No.	Standard Order No.	Engineering No.	Standard Order No.
3 Pole 	4.0A	250V AC/DC	8R3J26E03C3003	120070-5202	8R3J460003	120070-5204
4 Pole 	4.0A	250V AC/DC	8R4J26E03C3003	120011-0019	8R4J460003	120011-0281
5 Pole 	4.0A	250V AC/DC	8R5J26E03C3003	120011-0036	8R5J460003	120070-0235
8 Pole 	2.0A	30V AC / 36V DC	8R8J26E02C3003	120070-5209	8R8J460003	120070-5180

Note: Sales drawings for all standard order numbers are available on molex.com.
 Viton® is a registered trademark of E.I. DuPont De Nemours and Company.

Configuration Code*
 Build-a-Part Number

	Length	Code
Meters	0.3	C300
	1.0	M010

8R3J26E03C3003

→ Wire Type
 → Configuration

*Once an engineering number is created using the configuration code, consult Molex tech support for information regarding any part numbers.

Brad® Micro-Change® (M12) A-Code Field Attachable Connectors (Europe)

120071

Female, Male
Straight, Right Angle



Features and Benefits

- Allows field termination of cables to IEC compliant M12 A-Coding connector
- Preassembled contact carries with screw terminals provides easy field termination of conductors
- Available in 4- and 5-pole versions
- Back end housing and cable gland provides IP67 protection and strain relief



Physical

Connector Body: PA
Contact Carries: PA
O-ring: Viton®
Coupling Nut: Nickel-plated Brass
Contacts: Copper alloy with Gold over Nickel plating
Termination: Screw down terminals, accepts conductors up to 18 AWG (0.75mm²)



Environmental

Protection: IP67
NEMA Rating: NEMA 6

Female Connectors

Poles	Current per Contact	Max. Voltage	Cable Diameter Range	Female Straight		Female Right Angle	
				Engineering No.	Standard Order No.	Engineering No.	Standard Order No.
	4.0A	250V AC 300V DC	3.30-6.60mm (.130-.260")	8A4000-31	120071-0035	8A4001-31	120071-0037
			4.10-8.10mm (.161-.319")	8A4000-32	120071-0036		
	4.0A	30V AC 36V DC	3.30-6.60mm (.130-.260")	8A5000-31	120071-0041	8A5001-31	120071-0044
			4.10-8.10mm (.161-.319")	8A5000-32	120071-0043		

Male Connectors

Poles	Current per Contact	Max. Voltage	Cable Diameter Range	Male Straight		Male Right Angle	
				Engineering No.	Standard Order No.	Engineering No.	Standard Order No.
	4.0A	250V AC 300V DC	3.30-6.60mm (.130-.260")	8A4006-31	120071-0038	8A4007-31	120071-0040
			4.10-8.10mm (.161-.319")	8A4006-32	120071-0039		
	4.0A	30V AC 36V DC	3.30-6.60mm (.130-.260")	8A5006-31	120071-0045	8A5007-31	120071-0049
			4.10-8.10mm (.161-.319")	8A5006-32	120071-0047		

Note: Sales drawings for all standard order numbers are available on molex.com

Brad® Micro-Change® (M12) A-Code Solid Body Splitter and Tees (Europe)

120068



Features and Benefits

- Solid body splitters allow you to create a customized wiring scheme, either by combining two 3-conductor cables into a 5-conductor cable or implementing a trunk-and-drop wiring topology
- Splitters permit the connection of two I/O devices to a port on dual-wired distribution boxes
- Parallel wired tees allow for tapping into a cable run or implementing a trunk and drop wiring scheme

Electrical

Voltage: 30V
Amperage: 4.0A

Physical

Connector Body: PUR (PVC for grey or yellow splitters)
Contact Carries: PUR
O-ring: Viton®
Coupling Nut: Nickel-plated Brass
Contacts: Copper alloy with Gold over Nickel plating

Environmental

Protection: IP67
NEMA Rating: NEMA 6

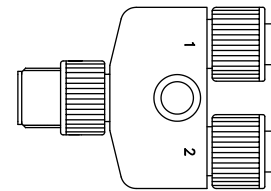

M12 Splitters

Wiring Schematic	Color	Engineering No.	Standard Order No.
<p>Without LEDs</p>	Yellow	81594R	120068-0170
<p>With LEDs</p>	Grey	81590R	120068-0169
	Black	0812-05EMF-00000	120068-0139
<p>With LEDs</p>	Clear	884AP0	120068-5035

Paralled Wired Tees/Splitters

Wiring Schematic	Color	Engineering No.	Standard Order No.	Engineering No.	Standard Order No.
	Black	0812-051FJ-00000	120068-8009	0812-05EMF-00001	120068-0137

Note: Viton® is a registered trademark of E.I. DuPont De Nemours and Company.

Brad® Micro-Change® (M12) A-Code Splitter Cordset (Europe)

120068/120009

Female Straight-to-Male Straight,
Female Right Angle-to-Male
Straight



Features and Benefits

- Splitters permit the connection of two I/O devices to a port on dual-wired distribution boxes
- IP67/68 rated for harsh environments
- Patented anti-vibration feature to prevent loosening under high-vibration applications
- Wide selection of cables to fit applications
 - PVC cables for light, cost-sensitive industrial applications
 - PUR cables for moderate flexing and for environments encountering cutting fluids and oils
 - TPE cables for continuous flex applications. Also ideal for welding cells; cable is weld slag resistant

Reference Information (K05 cable assemblies)

UL File No.: E152210
CSA File No.: LR6837

Physical

Connector Body: PUR (TPE for K05)
Contact Carries: Polyamide
O-ring: Viton® (EPDM for E03 cables)
Coupling Nut: Nickel-plated Brass (Teflon® coated for K05)
Contacts: Copper alloy with Gold over Nickel plating
Cables: E03—Black PVC jacket, 0.34mm² PVC conductors, 300V, 80° C, UL AWM 2464
P03—Black PUR/PVC jacket, 0.34mm² PVC conductors, 300V, 80° C
H09—Black PUR jacket, 0.34mm² PVC conductors, 300V, 80° C, Low Smoke/Zero Halogen (LSOH), UL AWM 21198
K05—Yellow TPE jacket, 22 AWG PVC conductors, 300V, UL PLTC-ER, +10M flex life (torsion and bending)

Environmental

Protection: IP67
NEMA Rating: NEMA 6

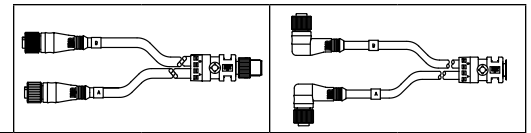

Wiring Schematic	Max. Current per Contact	Max. Voltage	Cable Type	Cable Jacket (Cable Code)	Wire Size	Length	Female Straight-to-Male Straight		Female Right Angle-to-Male Straight	
							Engineering No.	Standard Order No.	Engineering No.	Standard Order No.
								4.0A	250V AC/DC	UL 2464
	PUR/PVC (P03)	884A30P03M003	120009-0091							
LSOH, UL 21198	PUR (H09)	884A30H09M003	120068-8138	884A31H09M003	120068-8137					
PLTC-ER	TPE (K05)	884A30K05M003	120068-0195	884A31K05M003	120068-0211					

Note: Sales drawings for all standard order numbers are available on molex.com.
Teflon® and Viton® are registered trademarks of E.I. DuPont De Nemours and Company.

Configuration Code†
Build-a-Part Number

Length	Code
0.3	M003
0.6	M006
1.0	M010
3.0	M030
5.0	M050

884A30E03M0038

Coupling Nut Option
Stainless Steel 8

†Once an engineering number is created using the configuration code, consult Molex tech support for information regarding any part numbers.

Brad® Micro-Change® (M12) Distribution Boxes (Europe)

120114

Top Mount, Single Wired Ports With Brad® Mini-Change® HR Connector



Features and Benefits

- Fully potted, factory assembled boxes simplify on-machine wiring installations
- One input/output per port
- Indicating LEDs for power and sensor trigger indication
- Versions available for use with PNP and NPN sensors
- Mini-change Home Run connector for easy replacement

Reference Information

UL File No.: E152210
CSA File No.: LR6837

Electrical

Voltage: 10-30V DC max.
Amperage: Module—12.0A max.
Port—4.0A max.

Physical

Housing: PBT
Port Shell Material: Nickel-plated Brass
Contacts: Copper alloy with Gold over Nickel plating
Home Run Connector: Mini-change 12-pole male connector
Wiring Configuration: Single I/O, M12 4-pole female port

Environmental

Protection: IP67
NEMA Rating: NEMA 6

Port Configuration	Box Configuration	Ports	LED Indicator	For Sensor	Engineering No.	Standard Order No.
		4	No		BTY4010-FBB	120114-0027
		8			BTY8010-FBB	120114-0079
		4	Yes	NPN	BTY401N-FBB	120114-0014
		8			BTY801N-FBB	120114-0059
		4	Yes	PNP	BTY401P-FBB	120114-0019
		6			BTY601P-FBB	120114-0055
		8			BTY801P-FBB	120114-0065

Note: Sales drawings for all standard order numbers are available on molex.com

Suggested Home Run Cable Assemblies

Brad® Mini-Change® 12-pole Female Cordsets

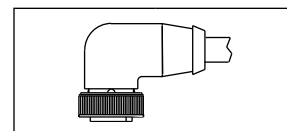

Use With	Cable Jacket	No. of Conductors	Cable Construction	Length	Engineering No.	Standard Order No.
4-port block	PUR	7	4 x 0.34mm ² + 3 x 0.75mm ²	10.0m	302301P80M100	130008-8009
6-port block		9	6 x 0.34mm ² + 3 x 0.75mm ²		302201P80M100	130008-8006
8-port block		11	8 x 0.34mm ² + 3 x 0.75mm ²		302101P80M100	130008-0476

Note: Sales drawings for all standard order numbers are available on molex.com

Configuration Code*

Build-a-Part Number

	Length	Code
Meters	5	050
	10	100
	15	150

302101P80M100

*Once an engineering number is created using the configuration code, consult Molex tech support for information regarding any part numbers.

Brad® Micro-Change® (M12) Distribution Boxes (Europe)

120114

Top Mount, Dual Wired Ports With Brad® Mini-Change® HR Connector



Features and Benefits

- Fully potted, factory assembled boxes simplify on-machine wiring installations
- Two input/outputs per port
- Indicating LEDs for power and sensor trigger indication
- Versions available for use with PNP and NPN sensors
- Mini-Change Home Run connector for easy replacement

Reference Information

UL File No.: E152210
CSA File No.: LR6837

Electrical

Voltage: 10-30V DC max.
Amperage: Module—12.0A max.
Port—4.0A max.

Physical

Housing: PBT
Port Shell Material: Nickel-plated Brass
Contacts: Copper alloy with Gold over Nickel plating
Home Run Connector: Mini-Change 19-pole male connector
Wiring Configuration: Dual I/O, M12 5-pole female port

Environmental

Protection: IP67
NEMA Rating: NEMA 6

Port Configuration	Box Configuration	Ports	LED Indicator	For Sensor	Engineering No.	Standard Order No.
		4	No		BTY4030-FBB	120114-0035
		8			BTY8030-FBB	120114-0087
		4	Yes	PNP	BTY403P-FBB	120114-0030
		8			BTY803P-FBB	120114-0083

Note: Sales drawings for all standard order numbers are available on molex.com

Suggested Home Run Cable Assemblies

Brad® Mini-Change® 19-pole Female Cordsets

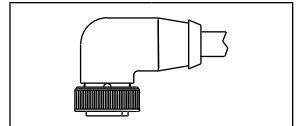

Use With	Cable Jacket	No. of Conductors	Cable Construction	Length	Engineering No.	Standard Order No.
4-port block	PUR	15	12 x 0.34mm ² + 3 x 0.75mm ²	10.0m	303201P80M100	130008-5006
8-port block		19	16 x 0.34mm ² + 3 x 0.75mm ²		303001P80M100	130008-0316

Note: Sales drawings for all standard order numbers are available on molex.com

Configuration Code*
Build-a-Part Number

	Length	Code
Meters	5	050
	10	100
	15	150

303001P80M100

*Once an engineering number is created using the configuration code, consult Molex tech support for information regarding any part numbers.

Brad® Micro-Change® (M12) Distribution Boxes (Europe)

120055/120114

Top Mount, Single Wired Ports With M23 HR Connector



Features and Benefits

- Fully potted, factory assembled boxes simplify on-machine wiring installations
- One input/output per port
- Indicating LEDs for power and sensor trigger indication
- Versions available for use with PNP and NPN sensors
- M23 Home Run connector for easy replacement

Reference Information

UL File No.: E152210
CSA File No.: LR6837

Electrical

Voltage: 10-30V DC max.
Amperage: Module—12.0A max.
Port—4.0A max.

Physical

Housing: PBT
Port Shell Material: Nickel-plated Brass
Contacts: Copper alloy with Gold over Nickel plating
Home Run Connector: M23 12-pole male connector
Wiring Configuration: Single I/O, M12 4-pole female port

Environmental

Protection: IP67
NEMA Rating: NEMA 6

Port Configuration	Box Configuration	Ports	LED Indicator	For Sensor	Engineering No.	Standard Order No.
		4	No		BTY4010-FBC	120055-0308
		8			BTY8010-FBC	120055-0321
		4	Yes	NPN	BTY401N-FBC	120114-0211
		8			BTY801N-FBC	120114-0060
		4	Yes	PNP	BTY401P-FBC	120114-0020
		8			BTY801P-FBC	120114-0066

Note: Sales drawings for all standard order numbers are available on molex.com

Suggested Home Run Cable Assemblies

M23 12-pole Female Cordsets and Field Attachable Connector

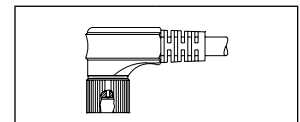

Use With	Cable Jacket	No. of Conductors	Cable Construction	Length	Engineering No.	Standard Order No.
4-port block	PUR	7	4 x 0.34mm ² + 3 x 0.75mm ²	10.0m	K02301P80M100	120094-5023
8-port block		11	8 x 0.34mm ² + 3 x 0.75mm ²		K02101P80M100	120094-0125
All		M23 12p Female Field Attachable Kit			KASCS00-025	120230-0032

Note: Sales drawings for all standard order numbers are available on molex.com

Configuration Code*

Build-a-Part Number

	Length	Code
Meters	5	050
	10	100
	15	150

K02101P80M100

*Once an engineering number is created using the configuration code, consult Molex tech support for information regarding any part numbers.

Brad® Micro-Change® (M12) Distribution Boxes (Europe)

120055/120114

Top Mount, Dual Wired Ports With M23 HR Connector



Features and Benefits

- Fully potted, factory assembled boxes simplify on-machine wiring installations
- Two input/outputs per port
- Indicating LEDs for power and sensor trigger indication
- versions available for use with PNP and NPN sensors
- M23 Home Run connector for easy replacement

Reference Information

UL File No.: E152210
CSA File No.: LR6837

Electrical

Voltage: 10-30V DC max.
Amperage: Module—12.0A max.
Port—4.0A max.

Physical

Housing: PBT
Port Shell Material: Nickel-plated Brass
Contacts: Copper alloy with Gold over Nickel plating
Home Run Connector: M23 19-pole male connector
Wiring Configuration: Dual I/O, M12 5-pole female port

Environmental

Protection: IP67
NEMA Rating: NEMA 6

Port Configuration	Box Configuration	Ports	LED Indicator	For Sensor	Engineering No.	Standard Order No.
		4	No		BTY4030-FBC	120055-0313
		8			BTY8030-FBC	120055-0328
		4	Yes	PNP	BTY403P-FBC	120114-0031
		8			BTY803P-FBC	120114-0084

Note: Sales drawings for all standard order numbers are available on molex.com

Suggested Home Run Cable Assemblies

M23 19-pole Female Cordsets

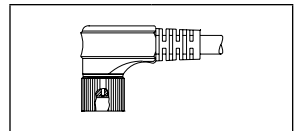

Use With	Cable Jacket	No. of Conductors	Cable Construction	Length	Engineering No.	Standard Order No.
6-port block	PUR	15	12 x 0.34mm ² + 3 x 0.75mm ²	10.0m	K03201P80M100	120094-8027
8-port block		19	16 x 0.34mm ² + 3 x 0.75mm ²		K03001P80M100	120094-0044

Note: Sales drawings for all standard order numbers are available on molex.com

Configuration Code*

Build-a-Part Number

	Length	Code
Meters	5	050
	10	100
	15	150

K03001P80M100

*Once an engineering number is created using the configuration code, consult Molex tech support for information regarding any part numbers.

Brad® Micro-Change® (M12) Distribution Boxes (Europe)

120055/120114

Top Mount, Dual Wired Ports With Field Attachable HR Terminal Strip



Features and Benefits

- Fully potted, factory assembled boxes simplify on-machine wiring installations
- Two input/outputs per port
- Indicating LEDs for power and sensor trigger indication
- Versions available for use with PNP and NPN sensors
- Home Run terminal strip provides greatest flexibility for cable choices and trimming to length on-machine

Reference Information

UL File No.: E152210
CSA File No.: LR6837

Electrical

Voltage: 10-30V DC max.
Amperage: Module—12.0A max.
Port—4.0A max.

Physical

Housing: PBT
Port Shell Material: Nickel-plated Brass
Contacts: Copper alloy with Gold over Nickel plating
Home Run Connector: Terminal strip
Wiring Configuration: Dual I/O, M12 5-pole female port

Environmental

Protection: IP67
NEMA Rating: NEMA 6

Port Configuration	Box Configuration	Ports	LED Indicator	For Sensor	Engineering No.	Standard Order No.
		4	No		BTY4030-FBA	120114-0034
		6			BTY6030-FBA	120114-0057
		8			BTY8030-FBA	120114-0086
		4	Yes	NPN	BTY403N-FBA	120055-0669
		6			BTY603N-FBA	120055-0670
		4	Yes	PNP	BTY403P-FBA	120114-0029
		6			BTY603P-FBA	120114-0056
		8			BTY803P-FBA	120114-0082

Note: Sales drawings for all standard order numbers are available on molex.com

Brad® Micro-Change® (M12) Distribution Boxes (Europe)

120055/120114

Top Mount, Single Wired Ports With PUR HR Cable



Features and Benefits

- Fully potted, factory assembled boxes simplify on-machine wiring installations
- One input/output per port
- Indicating LEDs for power and sensor trigger indication
- Versions available for use with PNP and NPN sensors
- Integral Home Run cable eliminates need for purchase of additional component for installation

Electrical

Voltage: 10-30V DC max.
 Amperage: Module—12.0A max.
 Port—4.0A max.

Physical

Housing: PBT
 Port Shell Material: Nickel-plated Brass
 Contacts: Copper alloy with Gold over Nickel plating
 Wiring Configuration: Single I/O, M12 4-pole female port
 Home Run Cable: Black PUR cable, conductors:
 4-port—4 x 0.34mm² + 3 x 0.75mm²
 6-port—6 x 0.34mm² + 3 x 0.75mm²
 8-port—8 x 0.34mm² + 3 x 0.75mm²

Environmental

Protection: IP67
 NEMA Rating: NEMA 6

Port Configuration	Box Configuration	Ports	LED Indicator	For Sensor	Length	Engineering No.	Standard Order No.
		8	No		5.0m	BTY8000-FBP-05	120055-0583
		4	Yes	NPN	5.0m	BTY400N-FBP-05	120114-8008
		8				BTY800N-FBP-05	120114-8020
		4	Yes	PNP	5.0m	BTY400P-FBP-05	120114-8011
		8				BTY800P-FBP-05	120114-8022

Note: Sales drawings for all standard order numbers are available on molex.com

Configuration Code*

Build-a-Part Number

	Length	Code
Meters	5	050
	10	100
	15	150

BTY800P-FBP-05

*Once an engineering number is created using the configuration code, consult Molex tech support for information regarding any part numbers.

Brad® Micro-Change® (M12) Distribution Boxes (Europe)

120114

Top Mount, Dual Wired Ports With PUR HR Cable



Features and Benefits

- Fully potted, factory assembled boxes simplify on-machine wiring installations
- Two input/outputs per port
- Indicating LEDs for power and sensor trigger indication
- Versions available for use with PNP and NPN sensors
- Integral Home Run cable eliminates need for purchase of additional component for installing

Reference Information

UL File No.: E152210
CSA File No.: LR6837

Electrical

Voltage: 10-30V DC max.
Amperage: Module—12.0A max.
Port—4.0A max.

Physical

Housing: PBT
Port Shell Material: Nickel-plated Brass
Contacts: Copper alloy with Gold over Nickel plating
Wiring Configuration: Dual I/O, M12 5-pole female port
Home Run Cable: Black PUR cable, conductors:
4-port—8 x 0.34mm² + 3 x 0.75mm²
6-port—12 x 0.34mm² + 3 x 0.75mm²
8-port—16 x 0.34mm² + 3 x 0.75mm²

Environmental

Protection: IP67
NEMA Rating: NEMA 6

Port Configuration	Box Configuration	Ports	LED Indicator	For Sensor	Length	Engineering No.	Standard Order No.
		4	No		5.0m	BTY4050-FBP-05	120114-0042
		8				BTY8050-FBP-05	120114-0092
		4	Yes	NPN	5.0m	BTY405N-FBP-05	120114-0037
		8				BTY805N-FBP-05	120114-0202
		4	Yes	PNP	5.0m	BTY405P-FBP-05	120114-0039
		8				BTY805P-FBP-05	120114-0089

Note: Sales drawings for all standard order numbers are available on molex.com

Configuration Code*

Build-a-Part Number

	Length	Code
Meters	5	050
	10	100
	15	150

BTY805P-FBP-05

*Once an engineering number is created using the configuration code, consult Molex tech support for information regarding any part numbers.

Brad® Micro-Change® (M12) Distribution Boxes (Europe)

120114

Top Mount, Dual Wired Ports with Molded Brad® Mini-Change® HR Cordset



Features and Benefits

- Fully potted, factory assembled boxes simplify on-machine wiring installations
- Single input/output per port
- Indicating LEDs for power and sensor trigger indication
- Versions available for use with PNP and NPN sensors
- Integral Home Run cordset with Mini-change 19-pole male connector provides easy replacement

Reference Information

UL File No.: E152210
CSA File No.: LR6837

Electrical

Voltage: 10-30V DC max.
Amperage: Module—12.0A max.
Port—4.0A max.

Physical

Housing: PBT
Port Shell Material: Nickel-plated Brass
Contacts: Copper alloy with Gold over Nickel plating
Wiring Configuration: Dual I/O, M12 5-pole female port
Home Run Cable: Black PUR cable, conductors:
4-port—8 x 0.34mm² + 3 x 0.75mm²
6-port—12 x 0.34mm² + 3 x 0.75mm²
8-port—16 x 0.34mm² + 3 x 0.75mm²

Environmental

Protection: IP67
NEMA Rating: NEMA 6

Port Configuration	Box Configuration	Ports	LED Indicator	For Sensor	Length	Engineering No.	Standard Order No.
		4	No		5.0m	BTY4120-FBP-05	120114-0048
		8				BTY8120-FBP-050	120114-0099
		4	Yes	NPN	5.0m	BTY412N-FBP-05	120114-0192
		8				BTY812N-FBP-05	120114-0095
		4	Yes	PNP	5.0m	BTY412P-FBP-05	120114-0045
		8				BTY812P-FBP-05	120114-0097

Note: Sales drawings for all standard order numbers are available on molex.com

Configuration Code*

Build-a-Part Number

	Length	Code
Meters	5	050
	10	100
	15	150

BTY812P-FBP-05

*Once an engineering number is created using the configuration code, consult Molex tech support for information regarding any part numbers.

Brad® Nano-Change® (M8) Connectors

EUROPE

Brad® Nano-Change® (M8) compact connectors and cordsets from Molex are part of a broad selection of rugged, space-saving cordsets, receptacles, inserts, splitters and molded junction boxes.

Nano-Change connectors meet IEC 61076-2-104 standards and are built "industrial tough" to ensure flexibility, interoperability and rugged performance in tight spaces while minimizing downtime, maintenance and wiring time.

Molex Nano-Change offerings include 3-, 4- and 5-pin designs. The cordsets are available with threaded and snap coupling options. A wide array of cable types provides flexibility to accommodate multiple applications.

The molded junction boxes feature a compact, space-saving design that allows simplification of control wiring systems, providing the opportunity for machine builders to design more modular devices. The Nano-Change cable system provides a way to reduce cable bundling expenses by reducing field install cabinets and field wire terminations.

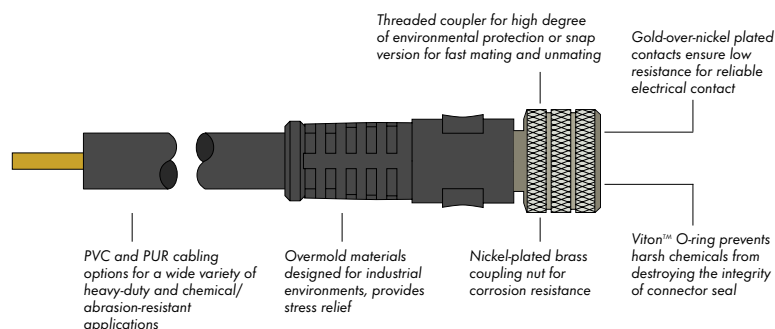

Features and Benefits

Cordsets

- Available with snap or threaded coupler; single- and double-ended cordsets; 3-, 4- and 5-pole configurations; straight and 90°; with and without LED to give users a wide variety of options to meet their requirements
- Compliant with IEC 61076-2-104, allowing intermating with industry-standard M8 devices
- IP67 (threaded) and IP65 (snap)-rated connector interfaces provide rugged, watertight connectors that are suited for harsh, wet environments
- Patented anti-vibration feature prevents backout in high-vibration and mechanical shock applications
- Gold-over-nickel-plated contacts feature a durable, corrosion-resistant plating that maintains low electrical resistance through the mate/unmate cycles

Receptacles, Field Attachables and Accessories

- Wide array of configurations, including front and back panel mount; with leads or PCB pins, give users a wide variety of options to meet their requirements
- Epoxy-potted, IP67-rated receptacles are ideal for rugged industrial environments

- Field attachable connectors with solder cup terminals allow users to customize their application

Distribution Boxes

- Available in 4-, 6-, 8- and 10-port distribution boxes. Single and dual I/O versions with vertical or horizontal mounting available, giving users a wide variety of options to meet application requirements.
- Fully potted housing ensures performance in vibration and fluid environments by providing rugged IP67 (IP68 cabled) rating
- Rugged, compact design allows placement in tight places anywhere on the machine

Applications

- 8.00mm proximity switches
- Miniature photo eyes
- Reed and hall effect switches
- Other miniature I/O devices and sensors
- Robotic end-of-arm tooling
- Specialty sensors semiconductor assembly equipment

Viton® is a registered trademark of E.I. DuPont De Nemours and Company.

Brad® Nano-Change® (M8) Single-Ended Cordsets (Europe)

120027/120086

Female, Pigtail
Straight, Right Angle
Threaded



Features and Benefits

- IEC compliant M8 cordset assemblies with threaded couplers
- Small, compact design for miniature sensors and space sensitive applications
- Available in 3-, 4-, and 5-pole versions
- Patented anti-vibration feature to prevent loosening under high-vibration applications
- IP67 rated for harsh environments
- LED version provide power and signal trigger indication for PNP sensors (NPN versions available upon request)
- Wide selection of cables to fit applications:
 - PVC cables for light, cost-sensitive industrial applications
 - PUR cables for moderate flexing and for environments encountering cutting fluids and oils
 - Other types available upon request

Physical

Connector Body: PUR
Contact Carries: PUR
O-ring: Viton®
Coupling Nut: Nickel-plated Brass
Contacts: Copper alloy with Gold over Nickel plating
Cables: E02—Black PVC jacket, 0.25mm² PVC conductors, 300V, 80° C, UL AWM 2464
P02—Black PUR/PVC jacket, 0.25mm² PVC conductors, 300V, 80° C
H08—Black PUR jacket, 0.25mm² TPM conductors, 300V, 80° C, Low Smoke/Zero Halogen (LSOH), UL AWM 21198

Environmental

Protection: IP67
NEMA Rating: NEMA 6

Reference Information

UL File No.: E152210 (PVC versions)

Cordset without Indicating LEDs

Pole	Current per Contact	Max. Voltage	Cable Type	Cable Jacket (Cable Code)	Wire Size	Length	Female Straight		Female Right Angle	
							Engineering No.	Standard Order No.	Engineering No.	Standard Order No.
3-Pole 1 - Brown 4 - Black 3 - Blue	4.0A	60V AC / 75V DC	UL 2464	PVC (E02)	0.25mm²	2.0m	403000E02M020	120027-0066	403001E02M020	120027-0090
				PUR/PVC (P02)			403000P02M020	120086-8001	403001P02M020	120086-8155
4-Pole 1 - Brown 3 - Blue 2 - White 4 - Black	4.0A	60V AC / 75V DC	UL 2464	PVC (E02)	0.25mm²	2.0m	404000E02M020	120027-0127	404001E02M020	120027-0152
				PUR/PVC (P02)			404000P02M020	120086-8156	404001P02M020	120086-8159
5-Pole 1 - Brown 4 - Black 2 - White 5 - Gray 3 - Blue	3.0A	60V AC / 75V DC	UL 2464	PVC (E02)	0.25mm²	2.0m	405000E02M020	120086-8099	405001E02M020	120086-8178
				PUR/PVC (P02)			405000P02M020	120027-0709	405001P02M020	120086-8391

Cordset with Indicating LEDs

Poles	Current per Contact	Max. Voltage	Cable Type	Cable Jacket (Cable Code)	Wire Size	Length	Female Right Angle	
							Engineering No.	Standard Order No.
3-Pole with 1 LED 1 - Brown 4 - Black 3 - Blue	4.0A	30V AC/DC	UL 2464	PVC (E02)	0.25mm²	2.0m	4030P1E02M020	120027-0115
			PUR/PVC (P02)	4030P1P02M020			120086-8337	

Note: Sales drawings for all standard order numbers are available on molex.com.

Viton® is a registered trademark of E.I. DuPont De Nemours and Company.

Configuration Code*
Build-a-Part Number

	Length	Code
Meters	2	M020
	5	M050
	10	M100

443000E02M020

Cable Code

*Once an engineering number is created using the configuration code, consult Molex tech support for information regarding any part numbers.

Brad® Nano-Change® (M8) Single-Ended Cordsets (Europe)

120027/120086

Male, Pigtail
Straight, Right Angle
Threaded



Features and Benefits

- IEC compliant M8 cordset assemblies with threaded couplers
- Small, compact design for miniature sensors and space sensitive applications
- Available in 3-, 4-, and 5-pole versions
- Patented anti-vibration feature to prevent loosening under high-vibration applications
- IP67 rated for harsh environments
- Wide selection of cables to fit applications:
 - PVC cables for light, cost-sensitive industrial applications
 - PUR cables for moderate flexing and for environments encountering cutting fluids and oils
 - Other types available upon request

Reference Information

UL File No.: E152210 (PVC versions)

Physical

Connector Body: PUR
 Contact Carries: PUR
 O-ring: Viton®
 Coupling Nut: Nickel-plated Brass
 Contacts: Copper alloy with Gold over Nickel plating
 Cables: E02—Black PVC jacket, 0.25mm² PVC conductors, 300V, 80° C, UL AWM 2464
 P02—Black PUR/PVC jacket, 0.25mm² PVC conductors, 300V, 80° C
 H08—Black PUR jacket, 0.25mm² TPM conductors, 300V, 80° C, Low Smoke/Zero Halogen (LSOH), UL AWM 21198

Environmental

Protection: IP67
 NEMA Rating: NEMA 6

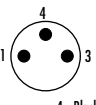
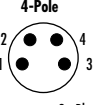
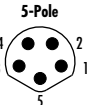
Poles	Current per Contact	Max. Voltage	Cable Type	Cable Jacket (Cable Code)	Wire Size	Length	Male Straight		Male Right Angle	
							Engineering No.	Standard Order No.	Engineering No.	Standard Order No.
							 1 - Brown 4 - Black 3 - Blue	4.0A	60V AC / 75V DC	UL 2464
	PUR/PVC (P02)	403006P02M020	120027-0911	403007P02M020	120086-8329					
 1 - Brown 3 - Blue 2 - White 4 - Black	4.0A	60V AC / 75V DC	UL 2464	PVC (E02)	0.25mm²	2.0m	404006E02M020	120086-8368	404007E02M020	120027-0483
			PUR/PVC (P02)	404006P02M020			120086-8373	404007P02M020	120086-8382	
 1 - Brown 4 - Black 2 - White 5 - Gray 3 - Blue	3.0A	60V AC / 75V DC	UL 2464	PVC (E02)	0.25mm²	2.0m	405006E02M020	120086-8173	405007E02M020	120086-8083
			PUR/PVC (P02)	405006P02M020			120027-0752	405007P02M020	120086-8061	

Note: Sales drawings for all standard order numbers are available on molex.com.
 Viton® is a registered trademark of E.I. DuPont De Nemours and Company.

Configuration Code*
 Build-a-Part Number

	Length	Code
Meters	2	M020
	5	M050
	10	M100

403006E02M020

→ Cable Code

*Once an engineering number is created using the configuration code, consult Molex tech support for information regarding any part numbers.

Brad® Nano-Change® (M8) Double-Ended Cordsets (Europe)

120028/120087

Female Straight-to-Male Straight,
Female Right Angle-to-Male Straight,
Female Straight-to-Male Right Angle,
Female Right Angle-to-Male
Right Angle
Threaded



Features and Benefits

- IEC compliant M8 cordset assemblies with threaded couplers
- Small, compact design for miniature sensors and space sensitive applications
- Available in 3-, 4-, and 5-pole versions
- Patented anti-vibration feature to prevent loosening under high-vibration applications
- IP67 rated for harsh environments
- Wide selection of cables to fit applications:
 - PVC cables for light, cost-sensitive industrial applications
 - PUR cables for moderate flexing and for environments encountering cutting fluids and oils
 - Other types available upon request

Reference Information

UL File No.: E152210 (PVC versions)

Physical

Connector Body: PUR
Contact Carries: PUR
O-ring: Viton®
Coupling Nut: Nickel-plated Brass
Contacts: Copper alloy with Gold over Nickel plating
Cables: E02—Black PVC jacket, 0.25mm² PVC conductors, 300V, 80° C, UL AWM 2464
P02—Black PUR/PVC jacket, 0.25mm² PVC conductors, 300V, 80° C
H08—Black PUR jacket, 0.25mm² TPM conductors, 300V, 80° C, Low Smoke/Zero Halogen (LSOH), UL AWM 21198

Environmental

Protection: IP67
NEMA Rating: NEMA 6

Poles (Female View)	Current per Contact	Max. Voltage	Cable Type	Cable Jacket (Cable Code)	Wire Size	Length	Female Straight-to-Male Straight		Female Right Angle-to-Male Straight	
							Engineering No.	Standard Order No.	Engineering No.	Standard Order No.
3-Pole 1 - Brown 4 - Black 3 - Blue	4.0A	60V AC / 75V DC	UL 2464	PVC (E02)	0.25mm²	1.0m	443030E02M010	120087-8258	443031E02M010	120028-0016
				PUR/PVC (P02)			443030P02M010	120087-8140	443031P02M010	120087-8316
4-Pole 1 - Brown 3 - Blue 2 - White 4 - Black	4.0A	60V AC / 75V DC	UL 2464	PVC (E02)	0.25mm²	1.0m	444030E02M010	120087-8349	444031E02M010	120087-8365
				PUR/PVC (P02)			444030P02M010	120087-8359	444031P02M010	120087-8372

Poles (Female View)	Current per Contact	Max. Voltage	Cable Type	Cable Jacket (Cable Code)	Wire Size	Length	Female Straight-to-Male Right Angle		Female Right Angle-to-Male Right Angle	
							Engineering No.	Standard Order No.	Engineering No.	Standard Order No.
3-Pole 1 - Brown 4 - Black 3 - Blue	4.0A	60V AC / 75V DC	UL 2464	PVC (E02)	0.25mm²	1.0m	443032E02M010	120087-8321	443033E02M010	120087-8329
				PUR/PVC (P02)			443032P02M010	120087-8324	443033P02M010	120087-8502
4-Pole 1 - Brown 3 - Blue 2 - White 4 - Black	4.0A	60V AC / 75V DC	UL 2464	PVC (E02)	0.25mm²	1.0m	444032E02M010	120087-8503	444033E02M010	120087-8507
				PUR/PVC (P02)			444032P02M010	120087-8504	444033P02M010	120087-8380

Note: Sales drawings for all standard order numbers are available on molex.com.
Viton® is a registered trademark of E.I. DuPont De Nemours and Company.

Configuration Code*
Build-a-Part Number

Length	Code
.3	M003
.6	M006
1	M010
2	M020
3	M030
4	M040
5	M050

443030E02M010

Cable Code

*Once an engineering number is created using the configuration code, consult Molex tech support for information regarding any part numbers.

Brad® Nano-Change® (M8) Receptacles (Europe)

120031/120090

Female
Front Panel Mount,
Back Panel Mount



Features and Benefits

- IEC compliant M8 panel mount receptacles
- Available in 3-, 4-, and 5-pole versions
- Fully potted assemblies provide IP67/68 protection for harsh environments
- Available in an array of configurations to fit your needs:
 - Various mounting thread sizes, including pipe threads for direct mounting on pipe fittings
 - Front panel mounts for installing from the outside of the enclosure
 - Back panel mount from inside the enclosure
 - Wire leads for terminating to terminal strips or PCB tails to incorporate with electronics

Physical

Shell Material: Nickel-plated Brass
 Contact Carries: PBT
 O-Ring: M8—Red Viton®
 Panel—Black Viton
 Contacts: Copper alloy with Gold over Nickel plating
 Wire PVC Insulation: 300V, 80° C, UL1007/1569, 0.25mm²

Environmental

Protection: IP67
 NEMA Rating: NEMA 6

Reference Information

UL File No.: E152210

Poles	Max. Current per Contact	Max. Voltage	Configuration		Engineering No.		Standard Order No.	
			Engineering No.	Standard Order No.	Engineering No.	Standard Order No.	Engineering No.	Standard Order No.
3-Pole 1 - Brown 4 - Black 3 - Blue	3.0A	60V AC/DC	4R3F30E02C3003	120031-0015	4R3H40E02C3003	120031-0046	4R3L40001	120149-0016
4-Pole 1 - Brown 3 - Blue 2 - White 4 - Black	3.0A	30V AC/DC	4R4F30E02C3003	120031-0049	4R4H40E02C3003	120031-0022	4R4L40001	120149-0064
5-Pole 1 - Brown 4 - Black 2 - White 5 - Gray 3 - Blue	3.0A	30V AC/DC	4R5F30E02C3003	120031-0028	4R5H40E02C3003	120031-0050	4R5L40001	120149-0095

Note: Sales drawings for all standard order numbers are available on molex.com.
 Viton® is a registered trademark of E.I. DuPont De Nemours and Company.

Configuration Code*
 Build-a-Part Number

	Length	Code
Meters	0.3	C300
	1.0	M010



*Once an engineering number is created using the configuration code, consult Molex tech support for information regarding any part numbers.

Brad® Nano-Change® (M8) Receptacles (Europe)

120090

Male
Front Panel Mount



Features and Benefits

- IEC compliant M8 panel mount receptacles
- Mates with threaded and snap M8 cordsets
- Available in 3-, 4-, and 5-pole versions
- Fully potted assemblies provide IP67/68 protection for harsh environments
- Receptacles with wired leads to be used in control panels, junction boxes and sensors. Other configurations also available

Reference Information

UL File No.: E152210

Physical

Shell Material: Nickel-plated Brass
 Contact Carries: PBT
 O-Ring: Panel—Black Viton®
 Contacts: Copper alloy with Gold over Nickel plating
 Wire PVC Insulation: 300V, 80° C, UL1007/1569, 0.25mm²

Environmental

Protection: IP67
 NEMA Rating: NEMA 6

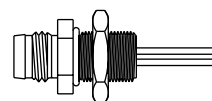

Configuration
 Wire Type
 Wire Size
 Length

M8x0.5, Front Panel Mount
 PVC Lead, UL1007/1569
 0.25mm²
 0.3m

Pole	Max. Current per Contact	Max. Voltage	Engineering No.	Standard Order No.
<p>3-Pole</p> <p>1 - Brown 3 - Blue 4 - Black</p>	4.0A	60V AC / 75V DC	4R3F06E02C3003	120031-0004
<p>4-Pole</p> <p>1 - Brown 2 - White 3 - Blue 4 - Black</p>	4.0A	60V AC / 75V DC	4R4F06E02C3003	120031-0006
<p>5-Pole</p> <p>1 - Brown 2 - White 3 - Blue 4 - Black 5 - Gray</p>	3.0A	60V AC / 75V DC	4R5F06E02C3003	120031-0027

Note: Sales drawings for all standard order numbers are available on molex.com.
 Viton® is a registered trademark of E.I. DuPont De Nemours and Company.

Configuration Code*
 Build-a-Part Number

	Length	Code
Meters	0.3	C300
	1.0	M010

4R3F06E02C3003

Wire Type
 Configuration

*Once an engineering number is created using the configuration code, consult Molex tech support for information regarding any part numbers.

Brad® Nano-Change® (M8) Threaded Field Attachable Connectors (Europe)

120091

Female, Male
Straight, Right Angle

Features and Benefits

- Allows field termination of cables to IEC compliant, M8 circular connector
- Preassembled contact carrier with solder cup contacts for easy conductor termination
- Small, compact design for miniature sensors and space sensitive applications
- Available in 3- and 4-pole versions
- Back end housing and cable gland provides IP67 protection and strain relief

Physical

Connector Body: PA
Contact Carries: PA
O-ring/Gaskets: NBR
Coupling Nut: Nickel-plated Brass
Contacts: Copper alloy with Gold over Nickel plating
Termination: Contacts with solder cups, accepts conductors up to 24 AWG (0.25mm²)

Environmental

Protection: IP67
NEMA Rating: NEMA 6



Female Connectors

Poles	Current per Contact	Max. Voltage	Cable Diameter Range	Female Straight		Female Right Angle	
				Engineering No.	Standard Order No.	Engineering No.	Standard Order No.
3-Pole 	4.0A	60V AC 75V DC	3.5-5.0mm (.137-.197")	N03FA03124	120091-0001	N03FA04124	120091-0003
4-Pole 	4.0A	60V AC 75V DC	3.5-5.0mm (.137-.197")	N04FA03124	120091-0007	N04FA04124	120091-0009

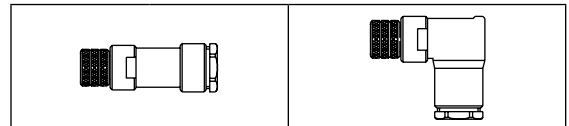

Male Connectors

Poles	Current per Contact	Max. Voltage	Cable Diameter Range	Male Straight		Male Right Angle	
				Engineering No.	Standard Order No.	Engineering No.	Standard Order No.
3-Pole 	4.0A	60V AC 75V DC	3.5-5.0mm (.137-.197")	N03MA03124	120091-0004	N03MA04124	120091-0006
4-Pole 	4.0A	60V AC 75V DC	3.5-5.0mm (.137-.197")	N04MA03124	120091-0010	N04MA04124	120091-0012

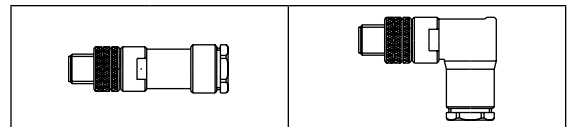

Note: Sales drawings for all standard order numbers are available on molex.com

Brad® Nano-Change® (M8) Distribution Boxes (Europe)

120113 Single Wired Ports with M16 HR Connector



Features and Benefits

- Fully potted, factory assembled boxes simplify on machine wiring installations
- Compact—small footprint for tight spaces
- Can be mounted in two orientations for added flexibility
- One input/output per port
- Indicating LEDs for power and sensor trigger indication
- M16 Home Run connector for easy replacement

Electrical

Voltage: 10-30V DC max.
Amperage: Module—6.0A max.
Port—2.0A max.

Physical

Housing: PBT
Port Shell Material: Nickel-plated Brass
Contacts: Copper alloy with Gold over Nickel plating
Home Run Connector: M16 14-pole male connector
Wiring Configuration: Single I/O, M8 3-pole female port
Operating Temperature: -25 to +90° C

Environmental

Protection: IP67
NEMA Rating: NEMA 6

Port Configuration	Box Configuration	Ports	LED Indicator	for Sensor	Engineering No.	Standard Order No.
		4	Yes	PNP	BNY401P-FBC	120113-0023
		6	Yes	PNP	BNY601P-FBC	120113-0026
		8	Yes	PNP	BNY801P-FBC	120113-0029
		10	Yes	PNP	BNYA01P-FBC	120113-0020

Suggested Home Run Cable Assemblies

M16 14-pole Female Cordsets

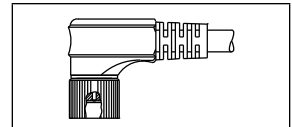

use with	Cable Jacket	No. conductors	Cable Construction	Length	Engineering No.	Standard Order No.
4port Block	PUR	6	Black PUR, 6x0.34mm ²	10.0m	L04301M78M100	130023-0063
6port Block		8	Black PUR, 8x0.34mm ²		L04201M78M100	130023-0059
8port Block		10	Black PUR, 10x0.34mm ²		L04101M78M100	130023-0055
10port Block		12	Black PUR, 12x0.34mm ²		L04A01M78M100	130023-0068

Note: Sales drawings for all standard order numbers are available on molex.com

Brad® Nano-Change® (M8) Distribution Boxes (Europe)

120113
Single Wired Ports with PUR HR Cable



Features and Benefits

- Fully potted, factory assembled boxes simplify on machine wiring installations
- Compact—small footprint for tight spaces
- Can be mounted in two orientations for added flexibility
- One input/output per port
- Indicating LEDs for power and sensor trigger indication
- Integral Home Run cable eliminates need for purchase of additional component for installing

Electrical

Voltage: 10-30V DC max.
Amperage: Module—6.0A max.
Port—2.0A max.

Physical

Housing: PBT
Port Shell Material: Nickel-plated Brass
Contacts: Copper alloy with Gold over Nickel plating
Wiring Configuration: Single I/O, M8 3-pole female port
Home Run Cable: Black PUR cable, conductors:
4-port—4x0.34mm² + 2x0.75mm²
6-port—6x0.34mm² + 2x0.75mm²
8-port—8x0.34mm² + 2x0.75mm²
10-port—10x0.34mm² + 2x0.75mm²

Environmental

Protection: IP67
NEMA Rating: NEMA 6

Port Configuration	Box Configuration	HR Cable Exit	Ports	LED Indicator	for Sensor	Length	Engineering No	Standard Order No
		End Exit	4	Yes	PNP	5.0m	BEY401P-FBP-05	120113-0006
			6	Yes	PNP	5.0m	BEY601P-FBP-05	120113-0011
			8	Yes	PNP	5.0m	BEY801P-FBP-05	120113-0014
			10	Yes	PNP	5.0m	BEYA01P-FBP-05	120113-0002
		Top Exit	4	Yes	PNP	5.0m	BNY401P-FBP-05	120113-0025
			8	Yes	PNP	5.0m	BNY801P-FBP-05	120113-0032
			10	Yes	PNP	5.0m	BNYA01P-FBP-05	120113-0022

Note: Sales drawings for all standard order numbers are available on molex.com

Configuration Code*
Build-a-Part Number

	Length	Code
Meters	5	05
	10	10
	15	15

BNYA01P-FBP-05

→ Cable Code

*Once an engineering number is created using the configuration code, consult Molex tech support for information regarding any part numbers.

Brad® Nano-Change® (M8) Distribution Boxes (Europe)

120054/120113
**Dual Wired Ports with
PUR HR Cable**



Features and Benefits

- Fully potted, factory assembled boxes simplify on machine wiring installations
- Compact—small footprint for tight spaces
- Can be mounted in two orientations for added flexibility
- One input/output per port
- Indicating LEDs for power and sensor trigger indication
- Integral Home Run cable eliminates need for purchase of additional component for installing

Electrical

Voltage: 10-30V DC max.
Amperage: Module—6.0A max.
Port—2.0A max.

Physical

Housing: PBT
Port Shell Material: Nickel-plated Brass
Contacts: Copper alloy with Gold over Nickel plating
Wiring Configuration: Dual I/O, M8 4-pole female port
Home Run Cable: Black PUR cable, conductors:
4-port—8x0.34mm² + 2x0.75mm²
6-port—12x0.34mm² + 2x0.75mm²
8-port—16x0.34mm² + 2x0.75mm²
10-port—20x0.25mm² + 2x0.50mm²

Environmental

Protection: IP67
NEMA Rating: NEMA 6

Port Configuration	Box Configuration	HR Cable Exit	Ports	LED Indicator	for Sensor	Length	Engineering No	Standard Order No
		End Exit	4	Yes	PNP	5.0m	BEY403P-FBP-05	120054-0034
			6	Yes	PNP	5.0m	BEY603P-FBP-05	120054-0043
			8	Yes	PNP	5.0m	BEY803P-FBP-05	120113-0017
			10	Yes	PNP	5.0m	BEYA03P-FBP-05	120054-0045
		Top exit	4	Yes	PNP	5.0m	BNY403P-FBP-05	120113-5100
			6	Yes	PNP	5.0m	BNY603P-FBP-05	120054-0044
			8	Yes	PNP	5.0m	BNY803P-FBP-05	120054-0004
			10	Yes	PNP	5.0m	BNYA03P-FBP-05	120054-0046

Note: Sales drawings for all standard order numbers are available on molex.com

Configuration Code*
Build-a-Part Number

	Length	Code
Meters	5	05
	10	10
	15	15

BEY803P-FBP-05

Cable Code

*Once an engineering number is created using the configuration code, consult Molex tech support for information regarding any part numbers.

Brad® Nano-Change® (M8) Single-Ended Cordsets (Europe)

120029/120086/120088

Female, Male Pigtails
SNAP
Straight, Right Angle



Features and Benefits

- IEC compliant M8 cordset assemblies with friction fit coupler design ('SNAP' design)
- Small, compact design for miniature sensors and space sensitive applications
- Available in 3- and 4-pole versions
- Push on to make connection, friction fit of snap feature keeps connection
- IP67 rated for harsh environments
- Wide selection of cables to fit applications:
 - PVC cables for light, cost-sensitive industrial applications
 - PUR cables for moderate flexing and for environments encountering cutting fluids and oils
 - Other types available upon request

Physical

Connector Body: PUR
Contact Carries: PUR
O-ring: Viton®
Coupling Nut: Nickel-plated Brass (male only)
Contacts: Copper alloy with Gold over Nickel plating
Cables: E02—Black PVC jacket, 0.25mm² PVC conductors, 300V, 80° C, UL AWM 2464
P02—Black PUR/PVC jacket, 0.25mm² PVC conductors, 300V, 80° C
H08—Black PUR jacket, 0.25mm² PVC conductors, 300V, 80° C, Low Smoke/Zero Halogen (LSOH), UL AWM 21198

Environmental

Protection: IP67
NEMA Rating: NEMA 6

Female Pigtails

Poles	Current per Contact	Max. Voltage	Cable Type	Cable Jacket (Cable Code)	Wire Size	Length	Female Straight		Female Right Angle	
							Engineering No.	Standard Order No.	Engineering No.	Standard Order No.
3-Pole 1 - Brown 4 - Black 3 - Blue 2 - Blue	4.0A	60V AC / 75V DC	UL 2464	PVC (E02)	0.25mm²	2.0m	503000E02M020	120088-8001	503001E02M020	120088-8086
				PUR/PVC (P02)			503000P02M020	120088-8083	503001P02M020	120088-8090
			LSOH, UL 21198	PUR (H08)			503000H08M020	120088-8122	503001H08M020	120088-8128
4-Pole 1 - Brown 3 - Blue 2 - White 4 - Black	4.0A	60V AC / 75V DC	UL 2464	PVC (E02)	0.25mm²	2.0m	504000E02M020	120088-8095	504001E02M020	120088-8124
				PUR/PVC (P02)			504000P02M020	120088-8123	504001P02M020	120088-8125
			LSOH, UL 21198	PUR (H08)			504000H08M020	120088-8121	504001H08M020	120088-8126

Male Pigtails

Poles	Current per Contact	Max. Voltage	Cable Type	Cable Jacket (Cable Code)	Wire Size	Length	Male Straight	
							Engineering No.	Standard Order No.
3-Pole 1 - Brown 4 - Black 3 - Blue	4.0A	60V AC / 75V DC	UL 2464	PVC (E02)	0.25mm²	2.0m	503006E02M020	120088-8093
				PUR/PVC (P02)			503006P02M020	120088-8130
			LSOH, UL 21198	PUR (H08)			503006H08M020	120088-8129
4-Pole 1 - Brown 3 - Blue 2 - White 4 - Black	4.0A	60V AC / 75V DC	UL 2464	PVC (E02)	0.25mm²	2.0m	504006E02M020	120088-8120
				PUR/PVC (P02)			504006P02M020	120088-8131
			LSOH, UL 21198	PUR (H08)			504006H08M020	120088-8127

Note: Sales drawings for all standard order numbers are available on molex.com.
Viton® is a registered trademark of E.I. DuPont De Nemours and Company.

Configuration Code*
Build-a-Part Number

	Length	Code
Meters	2	M020
	5	M050
	10	M100

503000E02M020

Cable Code

*Once an engineering number is created using the configuration code, consult Molex tech support for information regarding any part numbers.

Brad® Mini-Change® Connectors

Mini

The Brad® Mini-Change® connector family from Molex is the standard by which all industrial sealed connectors are measured.

With the introduction of the Mini-Change in 1968, Brad pioneered miniature connectors by offering the first quick-connect alternative to hardwiring. Today, Brad connectors from Molex continue to be recognized as the industry's leading connectors for their quality, durability and the widest selection in the market.

The Brad Mini-Change connector family from Molex includes molded cordsets and receptacles available in 2- through 12-pole and 19-pole configurations, straight or right angle. Field-installed connectors are available in 3-, 4- and 5-pole configurations. Hardware choices include epoxy-coated zinc die-cast, stainless steel and nylon. A large selection of custom configurations is also available.

To ensure a reliable, low-resistance connection, Molex uses the patented Quad Beam™ female contact with gold-over-nickel plating and a stainless steel sleeve. The sealed construction provides IP67 protection. An anti-vibration feature prevents the coupler from loosening, even under extreme conditions.

Brad Mini-Change connectors from Molex continue to evolve, providing the best, most cost-effective solution for tough connector applications.

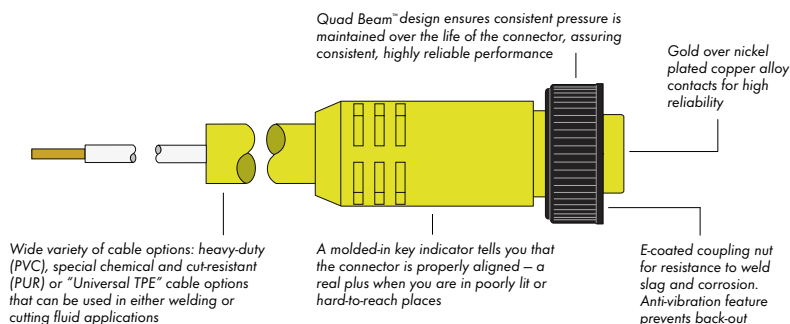

Features and Benefits

- Patented, Quad Beam™ socket contact with stainless steel sleeve maintains consistent pressure on the male pin to ensure optimum conductivity
- Gold-over-nickel-plated contacts are corrosion-resistant and help maintain low electrical resistance through high mate/unmate cycles
- Molded key indicator allows for quick and easy alignment and mating of the connector
- Integral strain relief provides 100 pounds minimum cable strain relief and radiates stress in side-loaded conditions
- Sealed to an IP67 rating to prevent the entry of water during temporary submersion

Applications

- 24V DC and 120V AC auxiliary power distribution on automated equipment
- Commercial and industrial lighting
- Industrial heaters
- Controls on Power Grid switchgear
- Power connector to WiLAN and WiMax transmitters
- Power connector to Smart Grid receiver stations
- Power connector to street light accessories
- Sump pump power and control
- Limit switches
- Proximity switches
- Photoelectric sensors
- Load cells
- Solenoid operated valves
- Valve position indicators
- Test equipment
- Portable/mobile light towers
- Solar panel power systems (from inverter to control panel)

Brad® Mini-Change® A-Size Single-Ended Cordsets

130006

**Female
Straight, Right Angle
Internal Thread**



Features and Benefits

- Patented Quad Beam™ contact provides high reliability and low resistance
- Epoxy coated coupling nut is corrosion and weld slag resistant
- Cable is oil, water and abrasion resistant

Reference Information

UL File No.: E152210
CSA File No.: LR6837

Environmental

Protection: IP67

Physical

Connector Face: PVC
Connector Body: PVC
Contacts: Brass with Gold over Nickel plating
Coupling Nut: Black epoxy-coated Zinc
Cable: A01, A02—UL Type STOOW, Hard Service Cord
A03, A05, A06, A07—UL 2661, AWM
C01—UL Type SOOW, Hard Service Cord
Cable Jacket Color: Yellow
Operating Temperature: A03, A05, A06, A07—
-20 to +80° C
A01, A02, C01— -20 to +105° C

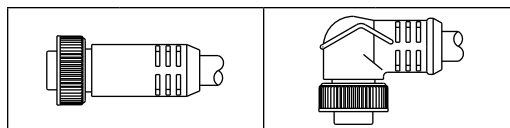

Poles (Female View)	Current	Voltage	Cable Type	Cable Jacket (Cable Code)	Wire Size AWG	Cable Length	Female Straight		Female Right Angle	
							Engineering No.	Standard Order No.	Engineering No.	Standard Order No.
2-Pole 1 - White 2 - Black	13.0A	600V AC/DC	STOOW	PVC (A01)	16	6'	102000A01F060	130006-0091	102001A01F060	130006-0137
3-Pole 1 - Green/Yellow-gnd 2 - Black 3 - White	13.0A	600V AC/DC	STOOW	PVC (A01)	16	6'	103000A01F060	130006-0221	103001A01F060	130006-0426
3-Pole 1 - Green-gnd 2 - Red w/ #2 3 - Red w/ #3	13.0A	600V AC/DC	STOOW	PVC (A02)	16	6'	103000A02F060	130006-0279	103001A02F060	130006-0452
3-Pole 1 - Green-gnd 2 - Red with black trace 3 - Red with white trace	10.0A	300V AC/DC	UL 2661	PVC (A03)	18	6'	103000A03F060	130006-0302		
3-Pole 1 - Green/Yellow-gnd 2 - Brown 3 - Blue	10.0A	300V AC/DC	UL 2661	PVC (A06)	18	2.0m	103000A06M020	130006-0339		
3-Pole 1 - Green-gnd 2 - Red with black trace 3 - Red with white trace	13.0A	600V AC/DC	SOOW	Rubber (C01)	16	6'	103000C01F060	130006-0377		

Configuration Code*
Build-a-Part Number

	Length	Code
Feet	3	F030
	6	F060
	12	F120
	20	F200
Meters	2	M020
	5	M050
	10	M100

102000A01**F060**1

Coupling Nut Option
Stainless Steel. 1
Nonmetallic 2

Cable Code
Orientation Code
Straight female. 000
Right angle female. 001

*Once an engineering number is created using the configuration code, consult Molex tech support for information regarding any part numbers.

Brad® Mini-Change® A-Size Single-Ended Cordsets

130006

Female

**Straight, Right Angle
Internal Thread**



Features and Benefits

- Patented Quad Beam™ contact provides high reliability and low resistance
- Epoxy coated coupling nut is corrosion and weld slag resistant
- Cable is oil, water and abrasion resistant

Reference Information

UL File No.: E152210
CSA File No.: LR6837

Physical

Connector Face: PVC
Connector Body: PVC
Contacts: Brass with Gold over Nickel plating
Coupling Nut: Black epoxy-coated Zinc
Cable: A01, A02—UL Type ST00W, Hard Service Cord
A03, A05, A06, A07—UL 2661, AWM
C01—UL Type S00W, Hard Service Cord
Cable Jacket Color: Yellow
Operating Temperature: A03, A05, A06, A07—
-20 to +80° C
A01, A02, C01— -20 to +105° C

Environmental

Protection: IP67

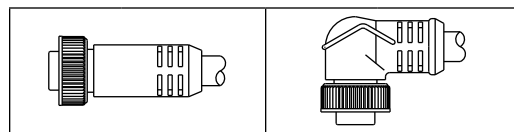

Poles (Female View)	Current	Voltage	Cable Type	Cable Jacket (Cable Code)	Wire Size AWG	Cable Length	Female Straight		Female Right Angle	
							Engineering No.	Standard Order No.	Engineering No.	Standard Order No.
4-Pole 1 - Black 2 - White 3 - Red 4 - Green/Yellow-gnd	10.0A	600V AC/DC	ST00W	PVC (A01)	16	6'	104000A01F060	130006-0728	104001A01F060	130006-0902
4-Pole 1 - Red with black trace 2 - Red with white trace 3 - Red 4 - Green-gnd	7.0A	300V AC/DC	UL 2661	PVC (A03)	18	6'	104000A03F060	130006-0813		
4-Pole 1 - Brown 3 - Blue 2 - White 4 - Black	5.6A	300V AC/DC	UL 2661	PVC (A05)	18	2.0m	104000A05M020	130006-0833		
4-Pole 1 - Black 2 - White 3 - Red 4 - Green-gnd	10.0A	600V AC/DC	S00W	Rubber (C01)	16	6'	104000C01F060	130006-0868		
5-Pole 1 - White 4 - Orange 2 - Red 5 - Black 3 - Green/Yellow-gnd	8.0A	600V AC/DC	ST00W	PVC (A01)	16	6'	105000A01F060	130006-1163	105001A01F060	130006-1349

Configuration Code*
Build-a-Part Number

	Length	Code
Feet	3	F030
	6	F060
	12	F120
	20	F200
Meters	2	M020
	5	M050
	10	M100

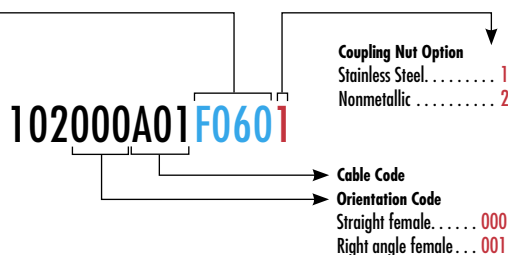

*Once an engineering number is created using the configuration code, consult Molex tech support for information regarding any part numbers.

Brad® Mini-Change® A-Size Single-Ended Cordsets

130006

Female Straight, Right Angle Internal Thread



Features and Benefits

- Patented Quad Beam™ contact provides high reliability and low resistance
- Epoxy coated coupling nut is corrosion and weld slag resistant
- Cable is oil, water and abrasion resistant

Reference Information

UL File No.: E152210
CSA File No.: LR6837

Physical

Connector Face: PVC
Connector Body: PVC
Contacts: Brass with Gold over Nickel plating
Coupling Nut: Black epoxy-coated Zinc
Cable: A01, A02—UL Type STOOW, Hard Service Cord
A03, A05, A06, A07—UL 2661, AWM
C01—UL Type SOOW, Hard Service Cord
Cable Jacket Color: Yellow
Operating Temperature: A03, A05, A06, A07—
-20 to +80° C
A01, A02, C01— -20 to +105° C

Environmental

Protection: IP67

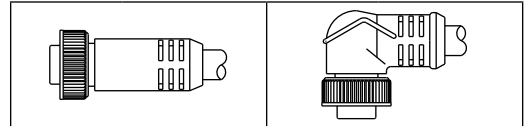

Poles (Female View)	Current	Voltage	Cable Type	Cable Jacket (Cable Code)	Wire Size AWG	Cable Length	Female Straight		Female Right Angle	
							Engineering No.	Standard Order No.	Engineering No.	Standard Order No.
5-Pole 1 - Red with #1 4 - Red with #4 2 - Red with #2 5 - Red with #5 3 - Green-gnd	8.0A	600V AC/DC	STOOW	PVC (A02)	16	6'	105000A02F060	130006-1240	105001A02F060	130006-1382
5-Pole 1 - Red with white trace 2 - Red 3 - Green-gnd 4 - Red with yellow trace 5 - Red with black trace	5.6A	300V AC/DC	UL 2661	PVC (A03)	18	6'	105000A03F060	130006-1257		
5-Pole 1 - Black 4 - Brown 2 - Blue 5 - White 3 - Green/Yellow-gnd	4.0A	300V AC/DC	UL 2661	PVC (A07)	20	2.0m	105000A07M020	130006-1275	105001A07M020	130006-1404
5-Pole 1 - Red with white trace 2 - Red 3 - Green-gnd 4 - Red with orange trace 5 - Red with black trace	8.0A	600V AC/DC	SOOW	Rubber (C01)	16	6'	105000C01F060	130006-1312		
6-Pole 1 - White 2 - Red 3 - Green/Yellow-gnd 4 - Orange 5 - Black 6 - Blue	8.0A	600V AC/DC	STOOW	PVC (A01)	16	6'	106000A01F060	130006-1583	106001A01F060	130006-1653

Note: Sales drawings for all standard order numbers are available on molex.com

Configuration Code*
Build-a-Part Number

	Length	Code
Feet	3	F030
	6	F060
	12	F120
	20	F200
Meters	2	M020
	5	M050
	10	M100

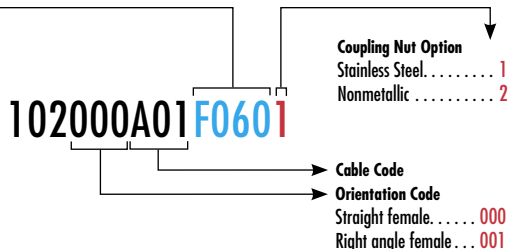

*Once an engineering number is created using the configuration code, consult Molex tech support for information regarding any part numbers.

Brad® Mini-Change® A-Size Single-Ended Cordsets

130006

Male

Straight, Right Angle
Internal Thread



Features and Benefits

- Low-resistance contact design with Gold over Nickel plating
- Epoxy-coated coupling nut is corrosion and weld slag resistant
- Cable is oil, water and abrasion resistant

Reference Information

UL File No.: E152210
CSA File No.: LR6837

Electrical

Voltage: 600V AC/DC

Mechanical

Wire Size: 16 AWG
Cable Type: UL Type STOOW

Physical

Connector Face: PVC
Connector Body: PVC
Contact: Brass with Gold over Nickel plating
Coupling Nut: Black epoxy-coated Zinc
Cable: UL Type STOOW, 105C
Hard Service Cord (A01)
Cable Jacket: PVC
Cable Jacket Color: Yellow
Operating Temperature: -20 to +105° C

Environmental

Protection: IP67

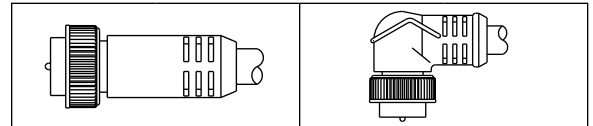

Poles (Male View)	Current	Cable Type	Cable Jacket (Cable Code)	Wire Size AWG	Length	Male Straight		Male Right Angle	
						Engineering No.	Standard Order No.	Engineering No.	Standard Order No.
2 Pole 1 - White 2 - Black	13.0A	STOOW	PVC (A01)	16	6'	102002A01F060	130006-0159		
3 Pole 1 - Green/Yellow-gnd 2 - Black 3 - White	13.0A	STOOW	PVC (A01)	16	6'	103002A01F060	130006-0534	103003A01F060	130006-0647
4 Pole 1 - Black 2 - White 3 - Red 4 - Green/Yellow-gnd	10.0A	STOOW	PVC (A01)	16	6'	104002A01F060	130006-0995	104003A01F060	130006-1087
5 Pole 1 - Red/White 4 - Red/Yel 2 - Red 5 - Red/Blk 3 - Green/Yellow-gnd	8.0A	STOOW	PVC (A01)	16	6'	105002A01F060	130006-1438	105003A01F060	130006-1518
6 Pole 1 - White 4 - Orange 2 - Red 5 - Black 3 - Green/Yellow-gnd 6 - Blue	8.0A	STOOW	PVC (A01)	16	6'	106002A01F060	130006-1675		

Note: Sales drawings for all standard order numbers are available on molex.com

Configuration Code*
Build-a-Part Number

Length	Code
3	F030
6	F060
12	F120
20	F200

102002A01**F060**1

Coupling Nut Option
Stainless Steel 1
Nonmetallic 2

Cable Code
Orientation Code
Straight male 002
Right angle male 003

*Once an engineering number is created using the configuration code, consult Molex tech support for information regarding any part numbers.

Brad® Mini-Change® A-Size Double-Ended Cordsets

130010
Female-to-Male
Straight
Internal Thread



Features and Benefits

- Patented Quad Beam™ contact provides high reliability and low resistance
- Epoxy coated coupling nut is corrosion and weld slag resistant
- Cable is oil, water and abrasion resistant

Reference Information

UL File No.: E152210
CSA File No.: LR6837

Electrical

Voltage: 600V AC/DC

Physical

Connector Face: PVC
Connector Body: PVC
Contact: Brass with Gold over Nickel plating
Coupling Nut: Black epoxy-coated Zinc
Cable: A01—UL Type STOOW, Hard Service Cord
C01—UL Type SOOW, Hard Service Cord
Cable Jacket Color: Yellow
Operating Temperature: -20 to +105° C

Environmental

Protection: IP67

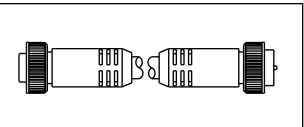

Poles (Female View)	Current	Cable Type	Cable Jacket (Cable Code)	Wire Size AWG	Length	Female-to-Male Straight	
						Engineering No.	Standard Order No.
2-Pole 	13.0A	STOOW	PVC (A01)	16	6'	112020A01F060	130010-0147
3-Pole 	13.0A	STOOW	PVC (A01)	16	6'	113020A01F060	130010-0221
	13.0A	SOOW	Rubber (C01)	16	6'	113020C01F060	130010-0307
4-Pole 	10.0A	STOOW	PVC (A01)	16	6'	114020A01F060	130010-0525
5-Pole 	8.0A	STOOW	PVC (A01)	16	6'	115020A01F060	130010-1005
6-Pole 	8.0A	STOOW	PVC (A01)	16	6'	116020A01F060	130010-1316

Note: Sales drawings for all standard order numbers are available on molex.com

Configuration Code*
Build-a-Part Number

Length	Code
3	F030
6	F060
12	F120
20	F200

112020A01F0601

Coupling Nut Option
Stainless Steel 1
Nonmetallic 2

Cable Code
Orientation Code
Straight female-to-straight male 020
Right angle female-to-straight male 021
Straight female-to-right angle male 022
Right angle female-to-right angle male 023

*Once an engineering number is created using the configuration code, consult Molex tech support for information regarding any part numbers.

Brad® Mini-Change® A-Size Double-Ended Cordsets

130010

External Thread Male-to-Internal Thread Female



Features and Benefits

- Patented Quad Beam™ contact provides high reliability and low resistance
- Epoxy-coated coupling nut is corrosion and weld slag resistant
- Cable is oil, water and abrasion resistant

Reference Information

UL File No.: E152210
CSA File No.: LR6837

Electrical

Voltage: 600V AC/DC

Mechanical

Wire Size: 16 AWG

Physical

Connector Face: PVC or TPE
Connector Body: PVC or TPE
Contact: Brass with Gold over Nickel plating
Coupling Nut: Black epoxy-coated Zinc
Cable: K12, K13—UL TC-ER Continuous-flex rated
A38—UL Type ST00W, Hard Service Cord
Cable Jacket Color: Yellow
Operating Temperature: -20 to +105° C

Environmental

Protection: IP67

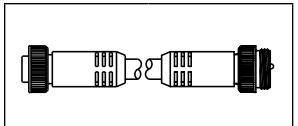

Poles (Female View)	Current	Cable Type	Cable Jacket (Cable Code)	Female-to-Male Straight	
				Engineering No.	Standard Order No.
3-Pole 	13.0A	TC-ER	TPE (K13)	113030K13M020	130010-0488
4-Pole 	10.0A	ST00W	PVC (A38)	114030A38M020	130010-0795
		TC-ER	TPE (K12)	114030K12M020	130010-0865
5-Pole 	8.0A	TC-ER	TPE (K13)	115030K13M020	130010-0103

Note: Sales drawings for all standard order numbers are available on molex.com

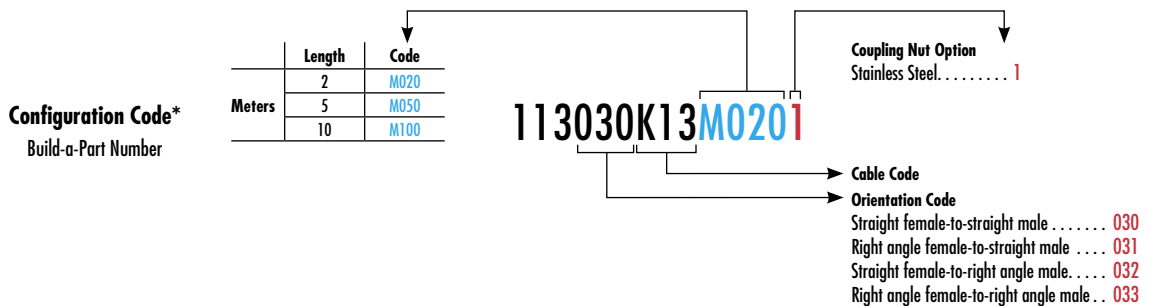

*Once an engineering number is created using the configuration code, consult Molex tech support for information regarding any part numbers.

Brad® Mini-Change® A-Size Receptacles With Leads

130013
Female
Internal Thread



Features and Benefits

- Patented Quad Beam™ contact provides high reliability and low resistance

Reference Information

UL File No.: E152210
CSA File No.: LR6837

Electrical

Voltage: 600V AC/DC

Mechanical

Wire Size: 16 AWG
Wire Type: UL 1015

Physical

Connector Face: PVC
Shell Material: Zinc with Nickel plate
Mounting Thread Size: 1/2" - 14 NPT
Cable Length: 2.0m (6.56')
Panel Mount: Front
Operating Temperature: -20 to +105° C

Environmental

Protection: IP67

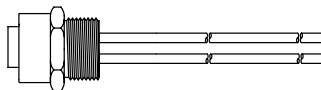

Poles	Current	Engineering No.	Standard Order No.
3 Pole 1 - Green/Yellow-gnd 2 - Black 3 - White	13.0A	1R3000A20M020	130013-0112
4 Pole 1 - Brown 3 - Blue 2 - White 4 - Black	8.0A	1R4000A39M020	130013-0301
5 Pole 1 - White 4 - Orange 2 - Red 5 - Black 3 - Green/Yellow-gnd	8.0A	1R5000A20M020	130013-0426

Note: Sales drawings for all standard order numbers are available on molex.com

Configuration Code*
Build-a-Part Number

	Length	Code
Inches	12	A120
Meters	2	M020

1R3000A20M0201

Coupling Nut Option
Stainless Steel 1

*Once an engineering number is created using the configuration code, consult Molex tech support for information regarding any part numbers.

Brad® Mini-Change® A-Size Receptacles With Leads

130013

**Female Straight, Right Angle
Front Mount
External Thread**



Features and Benefits

- Patented Quad Beam™ contact provides high reliability and low resistance

Reference Information

UL File No.: E152210

CSA File No.: LR6837

Physical

Connector Face: PVC

Shell Material:

Zinc with black epoxy coat or anodized Aluminum

Contact: Brass with Gold over Nickel plate

Operating Temperature: -20° to +105° C

Environmental

Protection: IP67

Configuration	Straight, Front Mount, 1/2-14" NPT	Right Angle, Front Mount, 1/2-14" NPT	Straight, Front Mount, Flange
Wire Type	PVC, UL1061	PVC, UL1061	PVC, UL1061
Wire Size AWG	16	16	16
Length	12"	12"	12"

Poles (Female View)	Current	Voltage	Engineering No.	Standard Order No.	Engineering No.	Standard Order No.	Engineering No.	Standard Order No.
2-Pole 1 - White 2 - Black	13.0A	600V AC/DC	1R2004A20A120	130013-0060	1R2005A20A120	130013-0074	1R2G04A20A120	130013-0093
3-Pole 1 - Green/Yellow-gnd 2 - Black 3 - White	13.0A	600V AC/DC	1R3004A20A120	130013-0135	1R3005A20A120	130013-0184	1R3G04A20A120	130013-0273
4-Pole 1 - Black 2 - White 3 - Red 4 - Green/Yellow-gnd	10.0A	600V AC/DC	1R4004A20A120	130013-0314	1R4005A20A120	130013-0337	1R4G04A20A120	130013-0402
5-Pole 1 - White 4 - Orange 2 - Red 5 - Black 3 - Green/Yellow-gnd	8.0A	600V AC/DC	1R5004A20A120	130013-0442	1R5005A20A120	130013-0482	1R5G04A20A120	130013-0550
6-Pole 1 - White 2 - Red 3 - Green/Yellow-gnd 4 - Orange 5 - Black 6 - Blue	8.0A	600V AC/DC	1R6004A20A120	130013-0567	1R6005A20A120	130013-0589	1R6G04A20A120	130013-0614

Note: Sales drawings for all standard order numbers are available on molex.com

Configuration Code*
Build-a-Part Number

	Length	Code
Inches	12	A120
Feet	6	F060

1R2004A20A120

Coupling Nut Option
 Stainless Steel1†
 Nonmetallic2‡

Orientation Code
 Straight female 004
 Right angle female 005
 Straight flange mount female shell G04

*Once an engineering number is created using the configuration code, consult Molex tech support for information regarding any part numbers.

†Stainless steel available only with straight, 1/2"-14 NPT shell or flange shell.

‡Nonmetallic available only with straight, 1/2"-14 NPT shell.

Brad® Mini-Change® A-Size Receptacles With Leads

130013

Male

**Straight, Right Angle
External Thread**



Features and Benefits

- Low-resistance contact design with Gold over Nickel plating

Reference Information

UL File No.: E152210

CSA File No.: LR6837

Physical

Connector Face: PVC

Shell Material:

Zinc with black epoxy coat or anodized Aluminum

Contact: Brass with Gold over Nickel plate

Operating Temperature: -20 to +105° C

Environmental

Protection: IP67

Poles (Male View)	Current	Voltage	Wire Size AWG	Engineering No.	Standard Order No.	Configuration		Engineering No.	Standard Order No.
						Wire Type			
						Length			
						Length			
 1 - White 2 - Black	13.0A	600V AC/DC	16	1R2006A20A120	130013-0076	Right Angle, Front Mount, 1/2-14" NPT	PVC, UL1061	1R2007A20A120	130013-0090
 1 - Green/Yellow-gnd 2 - Black 3 - White	13.0A	600V AC/DC	16	1R3006A20A120	130013-0202	Right Angle, Front Mount, 1/2-14" NPT	PVC, UL1061	1R3007A20A120	130013-0247
 1 - Green/Yellow-gnd 2 - Red with #2 3 - Red with #3	13.0A	600V AC/DC	16	1R3006A24A120	130013-0229	Straight, Front Mount, Flange	PVC, UL1061		
 1 - Green/Yellow-gnd 2 - Red with black trace 3 - Red with white trace	10.0A	300V AC/DC	18	1R3006A17A120	130013-0193	Straight, Front Mount, Flange	PVC, UL1061		

Note: Sales drawings for all standard order numbers are available on molex.com

Configuration Code*
Build-a-Part Number

	Length	Code
Inches	12	A120
Feet	6	F060
Meters	2	M020

1R2006A20A1201

Coupling Nut Option
Stainless Steel^{1†}
Nonmetallic^{2‡}

Cable Code
Orientation Code
Straight male 006
Right angle male 007
Straight flange mount male shell. G06

*Once an engineering number is created using the configuration code, consult Molex tech support for information regarding any part numbers.

[†]Stainless steel available only with straight, 1/2"-14 NPT shell or flange shell.

[‡]Nonmetallic available only with straight, 1/2"-14 NPT shell.

Brad® Mini-Change® A-Size Receptacles With Leads

130013

Male

**Straight, Right Angle
External Thread**



Features and Benefits

- Low-resistance contact design with Gold over Nickel plating

Reference Information

UL File No.: E152210

CSA File No.: LR6837

Physical

Connector Face: PVC

Shell Material:

Zinc with black epoxy coat or anodized Aluminum

Contact: Brass with Gold over Nickel plate

Operating Temperature: -20 to +105° C

Environmental

Protection: IP67

Poles (Male View)	Current	Voltage	Wire Size AWG	Configuration				Configuration			
				Straight, Front Mount, 1/2-14" NPT		Right Angle, Front Mount, 1/2-14" NPT		Straight, Front Mount, Flange		Straight, Front Mount, PG13.5	
				PVC, UL1061		PVC, UL1061		PVC, UL1061		PVC, UL1061	
				12"		12"		12"		12"	
Engineering No.	Standard Order No.	Engineering No.	Standard Order No.	Engineering No.	Standard Order No.	Engineering No.	Standard Order No.	Engineering No.	Standard Order No.		
 3-Pole 1 - Green/Yellow-gnd 2 - Brown 3 - Blue	10.0A	300V AC/DC	18	1R3006A25A120	130013-0238					1R3D06A25A120	130013-0268
 4-Pole 1 - Black 3 - Red 2 - White 4 - Green/Yellow-gnd	10.0A	600V AC/DC	16	1R4006A20A120	130013-0353	1R4007A20A120	130013-0386	1R4G06A20A120	130013-0409		
 4-Pole 1 - Brown 3 - Blue 2 - White 4 - Black	7.0A	300V AC/DC	18	1R4006A16A120	130013-0341					1R4D06A16A120	130013-0396

Note: Sales drawings for all standard order numbers are available on molex.com

Configuration Code*
Build-a-Part Number

	Length	Code
Inches	12	A120
Feet	6	F060
Meters	2	M020

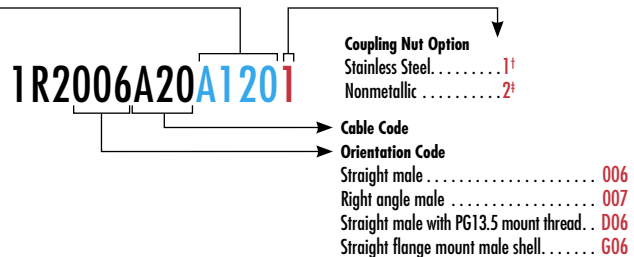

*Once an engineering number is created using the configuration code, consult Molex tech support for information regarding any part numbers.

¹Stainless steel available only with straight, 1/2"-14 NPT shell or flange shell.

²Nonmetallic available only with straight, 1/2"-14 NPT shell.

Brad® Mini-Change® A-Size Receptacles With Leads

130013

**Male Straight, Right Angle
External Thread**

Features and Benefits

- Low-resistance contact design with Gold over Nickel plating

Reference Information

UL File No.: E152210
CSA File No.: LR6837

Physical

Connector Face: PVC

Shell Material:

Zinc with black epoxy coat or anodized Aluminum

Contact: Brass with Gold over Nickel plate

Operating Temperature: -20 to +105° C

Environmental

Protection: IP67



Configuration	Wire Type	Wire Size AWG	Length
Straight, Front Mount, 1/2"-14" NPT	PVC, UL1061	16	12"
Right Angle, Front Mount, 1/2"-14" NPT	PVC, UL1061	16	12"
Straight, Front Mount, Flange	PVC, UL1061	16	12"
Straight, Front Mount, PG13.5	PVC, UL1061	18	12"

Pole (Male View)	Current	Voltage	Engineering No.	Standard Order No.	Engineering No.	Standard Order No.	Engineering No.	Standard Order No.	Engineering No.	Standard Order No.
5-Pole 1 - White 4 - Orange 2 - Red 5 - Black 3 - Green/Yellow-gnd	8.0A	600V AC/DC	1R5006A20A120	130013-0493	1R5007A20A120	130013-0534	1R5006A20A120	130013-0557		
5-Pole 1 - Red with #1 4 - Red with #4 2 - Red with #2 5 - Red with #5 3 - Green/Yellow-gnd	8.0A	600V AC/DC	1R5006A24A120	130013-0515						
5-Pole 1 - Red with white trace 4 - Red with yellow trace 2 - Red 5 - Red with black trace 3 - Green/Yellow-gnd	5.6A	300V AC/DC	1R5006A17A120	130013-0489						
5-Pole 1 - Black 4 - Brown 2 - Blue 5 - White 3 - Green/Yellow-gnd	5.6A	300V AC/DC							1R5006A25A120	130013-0548
6-Pole 1 - White 4 - Orange 2 - Red 5 - Black 3 - Green/Yellow-gnd 6 - Blue	8.0A	600V AC/DC	1R6006A20A120	130013-0593	1R6007A20A120	130013-0612	1R6006A20A120	130013-0620		

Note: Sales drawings for all standard order numbers are available on molex.com

Configuration Code*
Build-a-Part Number

	Length	Code
Inches	12	A120
Feet	6	F060
Meters	2	M020

1R2006A20A1201

Coupling Nut Option

Stainless Steel 1[†]
Nonmetallic 2[‡]

Cable Code

Orientation Code

Straight male 006
Right angle male 007
Straight male with PG13.5 mount thread... D06
Straight flange mount male shell. G06

*Once an engineering number is created using the configuration code, consult Molex tech support for information regarding any part numbers.

[†]Stainless steel available only with straight, 1/2"-14 NPT shell or flange shell.

[‡]Nonmetallic available only with straight, 1/2"-14 NPT shell.

Brad® Mini-Change® A-Size Bulkhead Pass-Through Receptacles

130013
Straight

Features and Benefits

- Patented Quad Beam™ contact provides high reliability and low resistance
- Allows through-panel quick connection

Reference Information

CSA File No.: LR6837

Mechanical

Voltage: 600V AC/DC

Physical

Connector Face: PVC
Contacts: Brass with Gold over Nickel plating
Shell: Nickel-plated Brass

Environmental

Protection: IP67

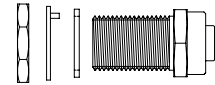

Poles (Female View)	Mounting Thread Size	Current	Straight	
			Engineering No.	Standard Order No.
<p>4-Pole</p>	7/8" - 16 UN-2A	10.0A	1R4030	130013-0388
<p>5-Pole</p>	7/8" - 16 UN-2A	8.0A	1R5030	130013-0541

Note: Sales drawings for all standard order numbers are available on molex.com

Brad® Mini-Change® A-Size Field Attachable Connectors With Screw Termination

130017
Female, Male
Straight
Internal/External Thread



Features and Benefits

- Patented Quad-Beam™ contact design for reliability and low resistance
- Allows easy conversion to quick-connect or the repair of damaged, molded connectors

Reference Information

CSA File No.: LR6837

Electrical

Voltage: 600V AC/DC

Mechanical

Wire Size: 15 to 24 AWG

Cable Range: 5.08 to 11.43mm (.200 to .450")

Physical

Connector Face: Polyurethane

Connector Body: Nylon

Contact: Brass with Gold over Nickel plating

Coupling Nut: Nickel-plated Brass

Operating Temperature: -20 to +80° C

Environmental

Protection: IP67

Poles (Female View)	Coupling Type	Current	Female Straight		Male Straight		Male Straight	
			Engineering No.	Standard Order No.	Engineering No.	Standard Order No.	Engineering No.	Standard Order No.
 3-Pole	Internal Thread	13.0A	1A3000-34	130017-0004			1A3002-34	130017-0008
	External Thread				1A3006-34	130017-0011		
 4-Pole	Internal Thread	10.0A	1A4000-34	130017-0015			1A4002-34	130017-0018
	External Thread				1A4006-34	130017-0020		
 5-Pole	Internal Thread	8.0A	1A5000-34	130017-0023			1A5002-34	130017-0026
	External Thread				1A5006-34	130017-0029		

Note: Sales drawings for all standard order numbers are available on molex.com

Configuration Code*

Build-a-Part Number

1A3000-348

Coupling Nut Option
Stainless Steel 8

*Once an engineering number is created using the configuration code, consult Molex tech support for information regarding any part numbers.

Brad® Mini-Change® A-Size Plugs for Liquid-Tight Conduit

130006/130018
Female, Male



Features and Benefits

- Patented Quad Beam™ contact design for reliability and low resistance
- Fits standard 1/2" liquid-tight conduit

Reference Information

UL File No.: E152210
CSA File No.: LR6837

Electrical

Voltage: 600V AC/DC

Mechanical

Wire Size: 16 AWG
Wire Type: UL 1015



Physical

Connector Face: PVC
Contact: Brass with Gold over Nickel plating
Connector Body: Zinc-plated Steel
Coupling Nut: Anodized Aluminum
Operating Temperature: -20 to +80° C

Environmental

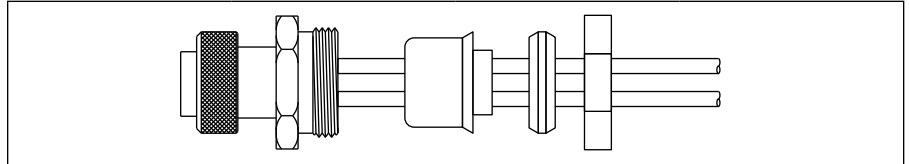
Protection: IP67

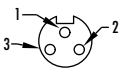

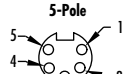
Poles (Female View)	Current	Female		Male	
		Engineering No.	Standard Order No.	Engineering No.	Standard Order No.
3-Pole  1 - Green-gnd 3 - White 2 - Black	13.0A	40925	130006-2099	41037	130006-2102
4-Pole  1 - Black 3 - Red 2 - White 4 - Green-gnd	10.0A	41132	130006-2103	51149	130018-0184
5-Pole  1 - White 4 - Orange 2 - Red 5 - Black 3 - Green-gnd	8.0A	41344	130006-2107	41593	130006-2109

Note: Sales drawings for all standard order numbers are available on molex.com

Brad® Mini-Change® A-Size Tee Connectors

120101/130006/130035
Female, Male



Features and Benefits

- Patented Quad Beam™ contact design for reliability and low resistance

Reference Information

UL File No.: E152210

Electrical

Voltage: 600V AC/DC

Physical

Connector Face: PVC

Connector Body: TPE

Contact: Brass with Gold over Nickel plating

Coupling Nut: Zinc with black epoxy coat

Operating Temperature: -20 to +105° C

Environmental

Protection: IP67

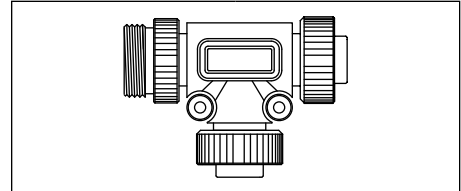

Poles (Female View)	Current	Female	
		Engineering No.	Standard Order No.
3-Pole 	10.0A	61056	130018-0217
4-Pole 	8.0A	DNETAUXPT	130035-0085
5-Pole 	8.0A	PBAPT	120101-0001

Note: Sales drawings for all standard order numbers are available on molex.com

Brad® Mini-Change® A-Size Adaptors

130018
Right Angle



Features and Benefits

- Patented Quad Beam™ contact design for reliability and low resistance

Reference Information

UL File No.: E152210
CSA File No.: LR6837

Electrical

Voltage: 600V AC/DC

Mechanical

Wire Size: 16 AWG

Physical

Connector Face: PVC
Connector Body: PVC
Contact: Brass Gold over Nickel plating
Coupling Nut: Zinc with black epoxy coat
Operating Temperature: -20 to +105° C

Environmental

Protection: IP67

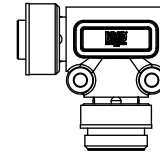

Poles (Female View)	Max. Current per Contact	Engineering No.	Standard Order No.
<p>2-Pole</p>	13.0A	40761	130018-0204
<p>3-Pole</p>	13.0A	41048	130018-0206
<p>4-Pole</p>	10.0A	41212	130018-0207
<p>5-Pole</p>	8.0A	41481	130018-0210

Brad® Mini-Change® A-Size Accessories

130201
Caps and Threaded Unions



Features and Benefits

- Protects connector from dust and moisture

Physical

Material: Anodized Aluminum
Chain: Zinc-plated Steel

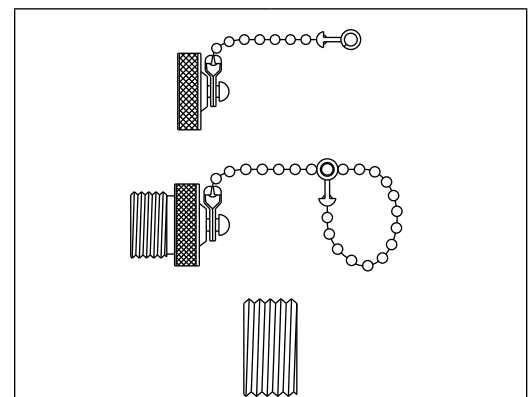

Closure Caps and Threaded Union

Type	Description	Engineering No.	Standard Order No.
Closure Cap	A-size with 7/8"-16UN-2B Internal Thread	65-0086	130201-1111
	A-size with 7/8"-16UN-2A External Thread	65-0085	130201-1109
Threaded Union	Adapter 7/8" External Thread	55-0426	130201-1224

Brad® Mini-Change® A-Size MPIS Distribution Boxes

130060

Side Mount
Single-Wired Ports



Features and Benefits

- Patented Quad Beam™ contact provides high reliability and low resistance
- Fully potted, factory assembled boxes simplify on machine wiring installations
- One input or output per port
- Brad® Mini-Change Home-run connector for easy replacement

Reference Information

UL Recognized—E152210
CSA Certified—LR6837

Electrical

Voltage: 600V AC/DC
Current: Module—7.0A max.
Port—10.0A max.

Physical

Housing: PET
Port Shell Material: Epoxy-coated Zinc
Connector Face: PVC
Contacts: Brass with Gold over Nickel plating
Home Run Connector: Brad Mini-Change male connector
Wiring Configuration: Single I/O, Brad Mini-Change 3-pole female port
Operating Temperature: -20 to +80° C

Environmental

Protection: IP67

Port Configuration	Ports	Box Configuration	Wiring Schematic	LED Indicator	Engineering No.	Standard Order No.
	4			No	409P401	130060-0001
<p>3 Pole</p> <p>1 - Ground 3 - Common (L1) 2 - Load (L2)</p>	6			No	409P601	130060-0012
	8			No	409P801	130060-0017

For connection to ports, see Brad Mini-Change 3-pole female-male internal double-ended cordsets

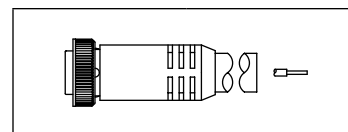

Suggested Home Run Cable Assemblies Brad Mini-Change Female Cordsets

Use With	Cable Jacket	No. of Conductors	Cable Construction	Length	Engineering No.	Standard Order No.
4-port block	PVC	6	6 x 16 AWG	12'	106000A01F120	130006-1590
6-port block	PVC	8	8 x 16 AWG	12'	208000A01F120	130007-0145
8-port block	PVC	10	10 x 16 AWG	12'	301000A01F120	130008-0028

Brad® Mini-Change® A-Size MPIS Distribution Boxes

130006

Side Mount
Single-Wired Ports with LEDs



Features and Benefits

- Patented Quad Beam™ contact provides high reliability and low resistance
- Fully potted, factory assembled boxes simplify on machine wiring installations
- One input or output per port
- Indicating LEDs for power and sensor trigger indication
- Brad Mini-Change Home-run connector for easy replacement

Reference Information

UL Recognized—E152210
CSA Certified—LR6837

Electrical

Voltage: 600V AC/DC
Current: Module—7.0A max.
Port—10.0A max.

Physical

Housing: PET
Port Shell Material: Epoxy-coated Zinc
Connector Face: PVC
Contacts: Brass with Gold over Nickel plating
Home Run Connector: Brad Mini-Change male connector
Wiring Configuration: Single I/O, Brad Mini-Change 3-pole female port
Operating Temperature: -20 to +80° C

Environmental

Protection: IP67

Port Configuration	Ports	Box Configuration	Wiring Schematic	LED Indicator	Engineering No.	Standard Order No.
	4		<p> J1 PIN 1 GROUND PIN 2 LOAD (L2) PIN 3 COMMON (L1) J3 PIN 1 GROUND PIN 2 LOAD (L2) PIN 3 COMMON (L1) J4 PIN 1 GROUND PIN 2 LOAD (L2) PIN 3 COMMON (L1) </p> <p> PIN 4 BROWN (LOAD H1, L2) PIN 5 WHITE (COMMON L1) PIN 6 GREEN (GROUND) PIN 7 GREEN (GROUND) PIN 8 BLACK (LOAD B1, L2) </p>	Yes	410P401	130060-0023
	6		<p> J1 PIN 1 GROUND PIN 2 LOAD (L2) PIN 3 COMMON (L1) J3 PIN 1 GROUND PIN 2 LOAD (L2) PIN 3 COMMON (L1) J5 PIN 1 GROUND PIN 2 LOAD (L2) PIN 3 COMMON (L1) </p> <p> PIN 4 RED/BLACK (LOAD H1, L2) PIN 5 WHITE (COMMON L1) PIN 6 GREEN (GROUND) PIN 7 GREEN (GROUND) PIN 8 BLACK (LOAD B1, L2) PIN 9 SYMBLAK (LOAD B2, L2) </p>	Yes	410P601	130060-0024
	8		<p> J1 PIN 1 GROUND PIN 2 LOAD (L2) PIN 3 COMMON (L1) J3 PIN 1 GROUND PIN 2 LOAD (L2) PIN 3 COMMON (L1) J5 PIN 1 GROUND PIN 2 LOAD (L2) PIN 3 COMMON (L1) J7 PIN 1 GROUND PIN 2 LOAD (L2) PIN 3 COMMON (L1) </p> <p> PIN 4 BROWN (LOAD H1, L2) PIN 5 WHITE (COMMON L1) PIN 6 GREEN (GROUND) PIN 7 GREEN (GROUND) PIN 8 BLACK (LOAD B1, L2) PIN 9 SYMBLAK (LOAD B2, L2) PIN 10 SYMBLAK (LOAD B3, L2) </p>	Yes	410P801	130060-0026

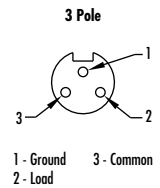

For connection to ports, see Brad Mini-Change 3-pole female-male internal double-ended cordsets

Suggested Home Run Cable Assemblies Brad Mini-Change Female Cordsets

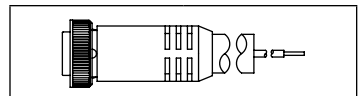

Use With	Cable Jacket	No. of Conductors	Cable Construction	Length	Engineering No.	Standard Order No.
4-port block	PVC	7	7 x 16 AWG	12'	207000A01F120	130007-0076
6-port block	PVC	9	9 x 16 AWG	12'	309000A01F120	130008-0329
8-port block	PVC	12	12 x 16 AWG	12'	302000A01F120	130008-0161

Brad® Mini-Change® A-Size MPIS Distribution Boxes

130060

Side Mount Series-Wired Ports



Features and Benefits

- Patented Quad Beam™ contact provides high reliability and low resistance
- Fully potted, factory assembled boxes simplify on machine wiring installations
- Series wired ports for AND or NOR wiring logic
- Brad Mini-Change Home-run connector for easy replacement

Reference Information

UL Recognized—E152210
CSA Certified—LR6837

Electrical

Voltage: 600V AC/DC
Amperage: Module—7.0A max.
Port—10.0A max.

Physical

Housing: PET
Port Shell Material: Epoxy-coated Zinc
Connector Face: PVC
Contacts: Brass with Gold over Nickel plating
Home Run Connector: Brad Mini-Change male connector
Wiring Configuration: Single I/O, Brad Mini-Change 3-pole female port
Operating Temperature: -20 to +80° C

Environmental

Protection: IP67

Port Configuration	Ports	Box Configuration	Wiring Schematic	LED Indicator	Engineering No.	Standard Order No.
<p>3 Pole</p> <p>1 - Ground 3 - Common 2 - Load (L2)</p>	4		<p>J1: PIN 1 GROUND, PIN 2 LOAD, PIN 3 POWER J2: PIN 1 GROUND, PIN 2 LOAD, PIN 3 POWER E3: PIN 1 GROUND, PIN 2 LOAD, PIN 3 POWER J4: PIN 1 GROUND, PIN 2 LOAD, PIN 3 POWER PIN 1 GREEN GROUND PIN 2 BLACK (LOAD (L2)) PIN 3 WHITE POWER (L1)</p>	No	409P403	130060-0002

For connection to ports, see Brad Mini-Change 3-pole female-male internal double-ended cordsets

Suggested Home Run Cable Assemblies Brad Mini-Change Female Cordsets

Use With	Cable Jacket	No. of Conductors	Cable Construction	Length	Engineering No.	Standard Order No.
4-port block	PVC	3	3 x 16 AWG	12'	103000A01F120	130006-0232

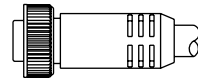

Brad® Mini-Change® A-Size MPIS Distribution Boxes

130060

Side Mount
Parallel-Wired Ports



Features and Benefits

- Patented Quad Beam™ contact provides high reliability and low resistance
- Fully Potted, factory assembled boxes simplify on machine wiring installations
- Each pole parallel-wired throughout the block for easy power or signal distribution
- Brad Mini-Change Home-Run connector for easy replacement

Electrical

Current: 3-pole—13.0A
4-pole—10.0A
Voltage: 600V AC/DC

Physical

Housing: PET
Port Shell Material: Epoxy-coated Zinc
Connector Face: PVC
Contacts: Brass with Gold over Nickel plating
Home Run Connector: Brad Mini-Change male connector
Wiring Configuration: Parallel-wired
Operating Temperature: -20 to +80° C

Environmental

Protection: IP67

Port Configuration	Ports	Box Configuration	Wiring Schematic	LED Indicator	Engineering No.	Standard Order No.
<p>3-Pole</p>	4			No	ACAUX4000	130060-0067
	8			No	ACAUX8000	130060-0068
<p>4-Pole</p>	4			No	DNAUX4000	130060-0065
	8			No	DNAUX8000	130060-0066

Suggested Port and Home Run Cable Assemblies Brad Mini-Change Female-Male Double Ended Cordsets

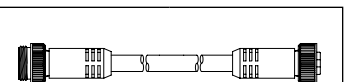

Use With	Cable Jacket	No. of Conductors	Cable Construction	Length	Engineering No.	Standard Order No.
4-port block	TPE	3	3 x 16 AWG	2.0m	113030K13M020	130010-0488
8-port block	TPE	4	4 x 16 AWG	2.0m	114030K12M020	130010-0865

Brad® Mini-Change® B-Size Single-Ended Cordsets

130007

**Female
Straight
Internal Thread**



Features and Benefits

- Patented Quad Beam™ contact provides high reliability and low resistance
- Epoxy coated coupling nut is corrosion and weld slag resistant
- Cable is oil, water and abrasion resistant

Reference Information

UL File No.: E152210
CSA File No.: LR6837

Electrical

Voltage: 600V AC/DC

Mechanical

Wire Size: 16 AWG
Cable Type: UL Type ST00W

Physical

Connector Face: PVC
Connector Body: PVC
Contact: Brass with Gold over Nickel plating
Coupling Nut: Black epoxy-coated Zinc
Cable: A01—UL Type ST00W, Hard Service Cord
Cable Jacket: PVC
Cable Jacket Color: Yellow
Operating Temperature: -20 to +105° C

Environmental

Protection: IP67

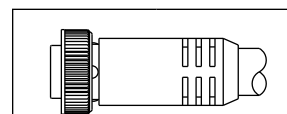

Poles	Current	Cable Type	Cable Jacket (Cable Code)	Wire Size AWG	Length	Female Straight	
						Engineering No.	Standard Order No.
<p>6 Pole</p> <p>1 - Orange 4 - White 2 - Blue 5 - Red 3 - Black 6 - Green/Yellow-gnd</p>	8.0A	ST00W	PVC (A01)	16	6'	206000A01F060	130007-0024
<p>7 Pole</p> <p>1 - White-Black Trace 4 - Red 2 - Black 5 - Orange 3 - White 6 - Blue 7 - Green/Yellow-gnd</p>	8.0A	ST00W	PVC (A01)	16	6'	207000A01F060	130007-0073
<p>8 Pole</p> <p>1 - Orange 5 - White 2 - Blue 6 - Red 3 - White-Black trace 7 - Green/Yellow-gnd 4 - Black 8 - Red-Black trace</p>	7.0A	ST00W	PVC (A01)	16	6'	208000A01F060	130007-0142

Note: Sales drawings for all standard order numbers are available on molex.com

Configuration Code*
Build-a-Part Number

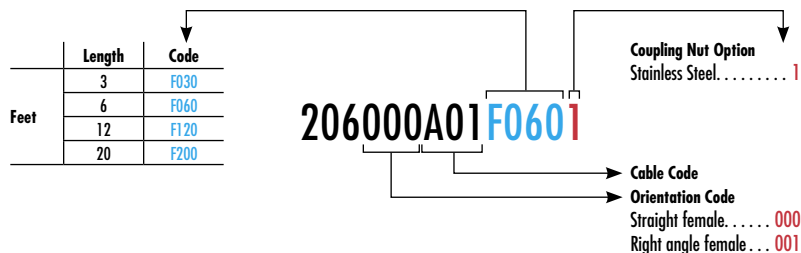

*Once an engineering number is created using the configuration code, consult Molex tech support for information regarding any part numbers.

Brad® Mini-Change® B-Size Single-Ended Cordsets

130007

Male
Straight
Internal Thread



Features and Benefits

- Low-resistance contact design with Gold over Nickel plating
- Epoxy coated coupling nut is corrosion and weld slag resistant
- Cable is oil, water and abrasion resistant

Reference Information

UL File No.: E152210
CSA File No.: LR6837

Electrical

Voltage: 600V AC/DC

Mechanical

Wire Size: 16 AWG
Cable Type: UL Type ST00W

Physical

Connector Face: PVC
Connector Body: PVC
Contact: Brass with Gold over Nickel plating
Coupling Nut: Black epoxy-coated Zinc
Cable: A01—UL Type ST00W, Hard Service Cord
Cable Jacket: PVC
Cable Jacket Color: Yellow
Operating Temperature: -20 to +105° C

Environmental

Protection: IP67

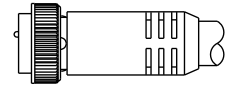

Poles	Current	Cable Type	Cable Jacket (Cable Code)	Wire Size AWG	Length	Male Straight	
						Engineering No.	Standard Order No.
<p>6 Pole</p> <p>1 - Orange 4 - White 2 - Blue 5 - Red 3 - Black 6 - Green/Yellow-gnd</p>	8.0A	ST00W	PVC (A01)	16	6'	206002A01F060	130007-0051
<p>7 Pole</p> <p>1 - White-black trace 4 - Red 2 - Black 5 - Orange 3 - White 6 - Blue 7 - Green/Yellow-gnd</p>	8.0A	ST00W	PVC (A01)	16	6'	207002A01F060	130007-0115
<p>8 Pole</p> <p>1 - Orange 5 - White 2 - Blue 6 - Red 3 - White-black trace 7 - Green/Yellow-gnd 4 - Black 8 - Red-black trace</p>	7.0A	ST00W	PVC (A01)	16	6'	208002A01F060	130007-0199

Note: Sales drawings for all standard order numbers are available on molex.com

Configuration Code*
Build-a-Part Number

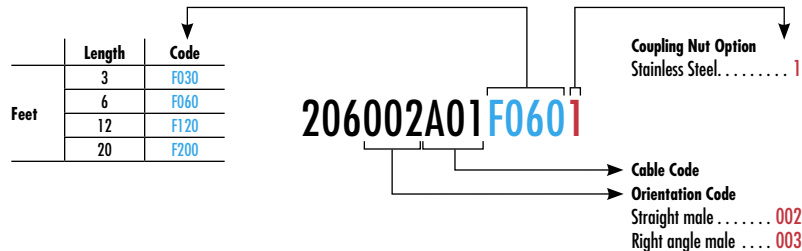

*Once an engineering number is created using the configuration code, consult Molex tech support for information regarding any part numbers.

Brad® Mini-Change® B-Size Double-Ended Cordsets

130011

Female Straight-to-Male Straight Internal Thread



Features and Benefits

- Patented Quad Beam™ contact provides high reliability and low resistance
- Epoxy-coated coupling nut is corrosion and weld slag resistant
- Cable is oil, water and abrasion resistant

Reference Information

UL File No.: E152210

CSA File No.: LR6837

Electrical

Voltage: 600V AC/DC

Mechanical

Wire Size: 16 AWG

Cable Type: UL Type ST00W

Physical

Connector Face: PVC

Connector Body: PVC

Contact: Brass with Gold over Nickel plating

Coupling Nut: Black epoxy-coated Zinc

Cable: A01—UL Type ST00W hard service cord

Cable Jacket: PVC

Cable Jacket Color: Yellow

Operating Temperature: -20 to +105° C

Environmental

Protection: IP67

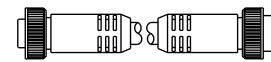

Female Straight-to-Male Straight

Pole (Female View)	Current	Cable Type	Cable Jacket (Cable Code)	Wire Size AWG	Length	Engineering No.	Order No.
	8.0A	ST00W	PVC (A01)	16	6'	226020A01F060	130011-0010
	8.0A	ST00W	PVC (A01)	16	6'	227020A01F060	130011-0051
	7.0A	ST00W	PVC (A01)	16	6'	228020A01F060	130011-0119

Note: Sales drawings for all standard order numbers are available on molex.com

Configuration Code*
Build-a-Part Number

Length	Code
3	F030
6	F060
12	F120
20	F200

Feet

226020A01F0601

Coupling Nut Option
Stainless Steel 1

Cable Code

Orientation Code

Straight female-to-straight male 020

Right angle female-to-straight male 021

Straight female-to-right angle male 022

Right angle female-to-right angle male 023

*Once an engineering number is created using the configuration code, consult Molex tech support for information regarding any part numbers.

Brad® Mini-Change® B-Size Receptacles With Leads

130014

**Female
External Thread**



Features and Benefits

- Patented Quad Beam™ contact provides high reliability and lower resistance

Reference Information

UL File No.: E152210

CSA File No.: LR6837

Electrical

Voltage: 600V AC/DC

Mechanical

Wire Size: 16 AWG

Wire Type: UL 1015

Physical

Connector Face: PVC

Shell Material: Zinc with black epoxy coat

Mounting Thread Size: 1/2" - 14 NPT

Panel Mount: Front

Cable Length: 0.305m (1.0')

Operating Temperature: -20 to +105° C

Environmental

Protection: IP67

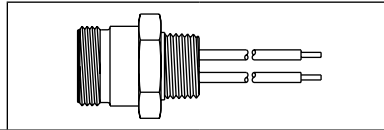

Poles	Current	Engineering No.	Standard Order No.
<p>6 Pole</p> <p>1 - Orange 4 - White 2 - Blue 5 - Red 3 - Black 6 - Green/Yellow-gnd</p>	8.0A	2R6004A20A120	130014-0015
<p>7 Pole</p> <p>1 - White-Black trace 4 - Red 2 - Black 5 - Orange 3 - White 6 - Blue 7 - Green/Yellow-gnd</p>	8.0A	2R7004A20A120	130014-0037
<p>8 Pole</p> <p>1 - Orange 5 - White 2 - Blue 6 - Red 3 - White-Black trace 7 - Green/Yellow-gnd 4 - Black 8 - Red-Black trace</p>	7.0A	2R8004A20A120	130014-0061

Note: Sales drawings for all standard order numbers are available on molex.com

Configuration Code*

Build-a-Part Number

	Length	Code
Inches	12	A120
Feet	6	F060

2R6004A20A1201

Coupling Nut Option
Stainless Steel 1

*Once an engineering number is created using the configuration code, consult Molex tech support for information regarding any part numbers.

Brad® Mini-Change® B-Size Receptacles With Leads

130014

**Male
External Thread**



Features and Benefits

- Low-resistance contact design with Gold over Nickel plating

Reference Information

UL File No.: E152210
CSA File No.: LR6837

Electrical

Voltage: 600V AC/DC

Mechanical

Wire Size: 16 AWG
Wire Type: UL 1015

Physical

Connector Face: PVC
Shell Material: Zinc with black epoxy coat
Mounting Thread Size: 1/2" - 14 NPT
Panel Mount: Front
Cable Length: 0.305m (1.0')
Operating Temperature: -20 to +105° C

Environmental

Protection: IP67

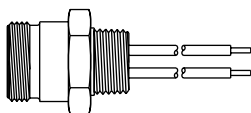

Poles	Current	Engineering No.	Standard Order No.
<p>6 Pole</p> <p>1 - Orange 4 - White 2 - Blue 5 - Red 3 - Black 6 - Green/Yellow-gnd</p>	8.0A	2R6006A20A120	130014-0025
<p>7 Pole</p> <p>1 - White with Black trace 4 - Red 2 - Black 5 - Orange 3 - White 6 - Blue 7 - Green/Yellow-gnd</p>	8.0A	2R7006A20A120	130014-0050
<p>8 Pole</p> <p>1 - Orange 5 - White 2 - Blue 6 - Red 3 - White with Black trace 7 - Green/Yellow-gnd 4 - Black 8 - Red with Black trace</p>	7.0A	2R8006A20A120	130014-0078

Note: Sales drawings for all standard order numbers are available on molex.com

Configuration Code*

Build-a-Part Number

	Length	Code
Inches	12	A120
Feet	6	F060

2R6006A20A120

Coupling Nut Option
Stainless Steel..... 1

*Once an engineering number is created using the configuration code, consult Molex tech support for information regarding any part numbers.

Brad® Mini-Change® B-Size Accessories

130201
Threaded

- Features and Benefits**
- Protects connector from dust and moisture

Physical
Material: Anodized Aluminum
Chain: Zinc-plated Steel

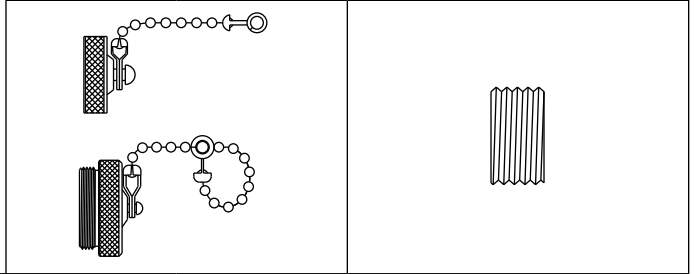

Product Name	Description	Engineering No.	Standard Order No.	Engineering No.	Standard Order No.
Closure Cap	1"-16UN-2B Internal Thread, Anodized Aluminum with Steel Bead Chain	65-0103	130201-1116		
	1"-16UN-2B External Thread, Anodized Aluminum with Steel Bead Chain	65-0102	130201-1115		
Threaded Union	Adapter, 1"-16UN-2A External Thread, Anodized Aluminum			55-0466	130201-1226

Brad® Mini-Change® C-Size Single-Ended Cordsets

130008

Female
Straight, Right Angle
Internal Thread



Features and Benefits

- Patented Quad Beam™ contact provides high reliability and low resistance
- Epoxy coated coupling nut is corrosion and weld slag resistant
- Cable is oil, water and abrasion resistant

Reference Information

UL File No.: E152210
CSA File No.: LR6837

Electrical

Voltage: 600V AC/DC

Mechanical

Wire Size: 16 AWG
Cable Type: UL Type ST00W

Physical

Connector Face: PVC
Connector Body: PVC
Contact: Brass with Gold over Nickel plating
Coupling Nut: Black epoxy-coated Zinc
Cable: A01—UL Type ST00W hard service cord
Cable Jacket: PVC
Cable Jacket Color: Yellow
Operating Temperature: -20 to +105° C

Environmental

Protection: IP67

						Female Straight		Female Right Angle	
Poles	Current	Cable Type	Cable Jacket (Cable Code)	Wire Size AWG	Length	Engineering No.	Order No.	Engineering No.	Order No.
<p>9 Pole</p> <p>1 - Orange 5 - White 2 - Blue 6 - Red 3 - Red-Black trace 7 - Green/Yellow-gnd 4 - Green-Black trace 8 - White-Black trace 9 - Black</p>	7.0A	ST00W	PVC (A01)	16	6'	309000A01F060	130008-0325	309001A01F060	130008-0351
<p>10 Pole</p> <p>1 - Orange 6 - Orange-Black trace 2 - Blue 7 - Red 3 - White-Black trace 8 - Green/Yellow-gnd 4 - Red-Black trace 9 - Black 5 - Green-Black trace 10 - White</p>	7.0A	ST00W	PVC (A01)	16	6'	301000A01F060	130008-0025	301001A01F060	130008-0098
<p>12 Pole</p> <p>1 - Orange 7 - Blue-Black trace 2 - Blue 8 - Black-White trace 3 - White-Black trace 9 - Green/Yellow-gnd 4 - Red-Black trace 10 - Red 5 - Green-Black trace 11 - White 6 - Orange-Black trace 12 - Black</p>	5.0A	ST00W	PVC (A01)	16	6'	302000A01F060	130008-0157	302001A01F060	130008-0212

Note: Sales drawings for all standard order numbers are available on molex.com

Configuration Code*
Build-a-Part Number

Length	Code
3	F030
6	F060
12	F120
20	F200

309000A01F0601

Coupling Nut Option
Stainless Steel 1

Cable Code
Orientation Code
Straight female 000
Right angle female 001

*Once an engineering number is created using the configuration code, consult Molex tech support for information regarding any part numbers.

Brad® Mini-Change® C-Size Single-Ended Cordsets

130008

Male
Straight
Internal Thread



Features and Benefits

- Low-resistance contact design with Gold over Nickel plating
- Epoxy coated coupling nut is corrosion and weld slag resistant
- Cable is oil, water and abrasion resistant

Reference Information

UL File No.: E152210
CSA File No.: LR6837

Electrical

Voltage: 600V AC/DC

Mechanical

Wire Size: 16 AWG
Cable Type: UL Type STOOW

Physical

Connector Face: PVC
Connector Body: PVC
Contact: Brass with Gold over Nickel plating
Coupling Nut: Black epoxy-coated Zinc
Cable: A01—UL Type STOOW hard service cord
Cable Jacket: PVC
Cable Jacket Color: Yellow
Operating Temperature: -20 to +105° C

Environmental

Protection: IP67

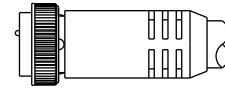

Male Straight

Poles	Current	Cable Type	Cable Jacket (Cable Code)	Wire Size AWG	Length	Engineering No.	Order No.
<p>9 Pole</p> <p>1 - Orange 5 - White 2 - Blue 6 - Red 3 - Red-Black trace 7 - Green/Yellow-gnd 4 - Green-Black trace 8 - White-Black trace 9 - Black</p>	7.0A	STOOW	PVC (A01)	16	6'	309002A01F060	130008-0366
<p>10 Pole</p> <p>1 - Orange 6 - Orange-Black trace 2 - Blue 7 - Red 3 - White-Black trace 8 - Green/Yellow-gnd 4 - Red-Black trace 9 - Black 5 - Green-Black trace 10 - White</p>	7.0A	STOOW	PVC (A01)	16	6'	301002A01F060	130008-0117
<p>12 Pole</p> <p>1 - Orange 7 - Blue-Black trace 2 - Blue 8 - Black-White trace 3 - White-Black trace 9 - Green/Yellow-gnd 4 - Red-Black trace 10 - Red 5 - Green-Black trace 11 - White 6 - Orange-Black trace 12 - Black</p>	5.0A	STOOW	PVC (A01)	16	6'	302002A01F060	130008-0231

Note: Sales drawings for all standard order numbers are available on molex.com

Configuration Code*
Build-a-Part Number

Length	Code
3	F030
6	F060
12	F120
20	F200

309002A01F0601

Coupling Nut Option
Stainless Steel. 1

Cable Code
Orientation Code
Straight male 002
Right angle male 003

*Once an engineering number is created using the configuration code, consult Molex tech support for information regarding any part numbers.

Brad® Mini-Change® C-Size Double-Ended Cordsets

130012

Female Straight-to-Male Straight Internal Thread



Features and Benefits

- Patented Quad Beam™ provides high reliability and low resistance
- Epoxy-coated coupling nut is corrosion and weld slag resistant
- Cable is oil, water and abrasion resistant

Reference Information

UL File No.: E152210
CSA File No.: LR6837

Electrical

Voltage: 600V AC/DC

Mechanical

Wire Size: 16 AWG
Cable Type: UL Type ST00W

Physical

Connector Face: PVC
Connector Body: PVC
Contact: Brass with Gold over Nickel plating
Coupling Nut: Black epoxy-coated Zinc
Cable: A01—UL Type ST00W extra hard service cord
Cable Jacket: PVC
Cable Jacket Color: Yellow
Operating Temperature: -20 to +105° C

Environmental

Protection: IP67

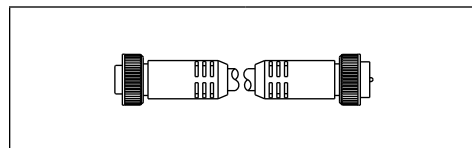

Female Straight-to-Male Straight

Pole (Female View)	Current	Cable Type	Cable Jacket (Cable Code)	Wire Size AWG	Length	Engineering No.	Order No.
9 Pole 	7.0A	ST00W	PVC (A01)	16	6'	339020A01F060	130012-0385
10 Pole 	7.0A	ST00W	PVC (A01)	16	6'	331020A01F060	130012-0009
12 Pole 	5.0A	ST00W	PVC (A01)	16	6'	332020A01F060	130012-0113

Note: Sales drawings for all standard order numbers are available on molex.com

Configuration Code*
Build-a-Part Number

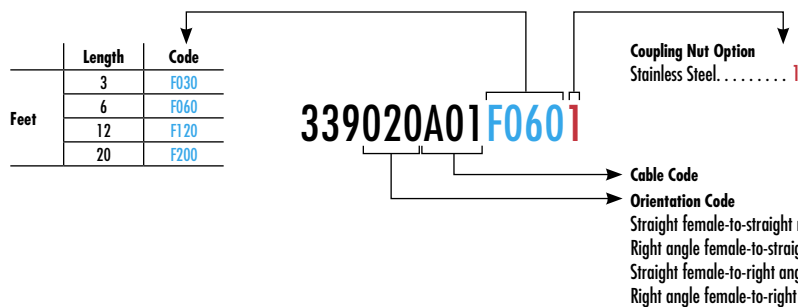

*Once an engineering number is created using the configuration code, consult Molex tech support for information regarding any part numbers.

Brad® Mini-Change® C-Size Receptacles With Leads

130015

**Female
External Thread**



Features and Benefits

- Patented Quad Beam™ contact provides high reliability and low resistance

Reference Information

UL File No.: E152210
CSA File No.: LR6837

Electrical

Voltage: 600V AC/DC

Mechanical

Wire Size: 16 AWG
Wire Type: UL 1015

Physical

Connector Face: PVC
Shell Material: Zinc with black epoxy coat
Mounting Thread Size: 1/2" - 14 NPT
Panel Mount: Front
Cable Length: 0.305m (1.0')
Operating Temperature: -20 to +105° C

Environmental

Protection: IP67

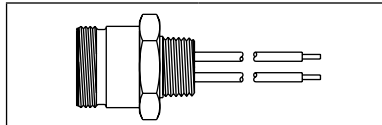

Poles	Current	Engineering No.	Standard Order No.
<p>9 Pole</p> <p>1 - Orange 5 - White 2 - Blue 6 - Red 3 - Red-Black trace 7 - Green/Yellow-gnd 4 - Green-Black trace 8 - White-Black trace 9 - Black</p>	7.0A	3R9004A20A120	130015-0117
<p>10 Pole</p> <p>1 - Orange 6 - Orange-Black trace 2 - Blue 7 - Red 3 - White-Black trace 8 - Green/Yellow-gnd 4 - Red-Black trace 9 - Black 5 - Green-Black trace 10 - White</p>		3R1004A20A120	130015-0024
<p>12 Pole</p> <p>1 - Orange 7 - Blue-Black trace 2 - Blue 8 - Black-White trace 3 - White-Black trace 9 - Green/Yellow-gnd 4 - Red-Black trace 10 - Red 5 - Green-Black trace 11 - White 6 - Orange-Black trace 12 - Black</p>	5.0A	3R2004A20A120	130015-0054

Note: Sales drawings for all standard order numbers are available on molex.com

Configuration Code*
Build-a-Part Number

	Length	Code
Inches	12	A120
Feet	6	F060

3R9004A20A1201

Coupling Nut Option
Stainless Steel..... 1

*Once an engineering number is created using the configuration code, consult Molex tech support for information regarding any part numbers.

Brad® Mini-Change® C-Size Receptacles With Leads

130015

**Male
External Thread**



Features and Benefits

- Low resistance contact design with Gold over Nickel plating

Reference Information

UL File No.: E152210
CSA File No.: LR6837

Electrical

Voltage: 600V AC/DC

Mechanical

Wire Size: 16 AWG
Wire Type: UL 1015

Physical

Connector Face: PVC
Shell Material: Zinc with black epoxy coat
Mounting Thread Size: 1/2" - 14 NPT
Panel Mount: Front
Cable Length: 0.305m (1.0')
Operating Temperature: -20 to +105° C

Environmental

Protection: IP67

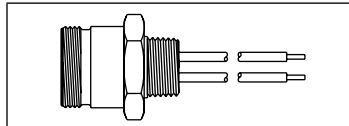

Poles	Current	Engineering No.	Standard Order No.
<p>9 Pole</p> <p>1 - Orange 5 - White 2 - Blue 6 - Red 3 - Red with Black trace 7 - Green/Yellow-gnd 4 - Green with Black trace 8 - White with Black trace 9 - Black</p>	7.0A	3R9006A20A120	130015-0137
<p>10 Pole</p> <p>1 - Orange 6 - Orange with Black trace 2 - Blue 7 - Red 3 - White with Black trace 8 - Green/Yellow-gnd 4 - Red with Black trace 9 - Black 5 - Green with Black trace 10 - White</p>		3R1006A20A120	130015-0044
<p>12 Pole</p> <p>1 - Orange 7 - Blue with Black trace 2 - Blue 8 - Black with White trace 3 - White with Black trace 9 - Green/Yellow-gnd 4 - Red with Black trace 10 - Red 5 - Green with Black trace 11 - White 6 - Orange with Black trace 12 - Black</p>		5.0A	3R2006A20A120

Note: Sales drawings for all standard order numbers are available on molex.com

Configuration Code*
Build-a-Part Number

	Length	Code
Inches	12	A120
Feet	6	F060

3R9006A20A120

Coupling Nut Option
Stainless Steel. 1

*Once an engineering number is created using the configuration code, consult Molex tech support for information regarding any part numbers.

Brad® Mini-Change® C-Size 19-Pole Single and Double-Ended Cordsets

130008/130012

**Female Straight, Right Angle
(Single-Ended)**

**Female Straight-to-Male Straight
(Double-Ended)**

Threaded

Features and Benefits

- 18 AWG power and 22 AWG control conductors
- Oil and abrasion-resistant polyurethane (PUR) jacket

Electrical

Current per Contact: 3.0A/2.0A
Voltage: 300V AC/DC

Mechanical

Wire Size: 18/22 AWG

Physical

Connector Face: PVC
Connector Body: PVC
Contact: Brass with Gold over Nickel plating
Coupling Nut: Black epoxy-coated Zinc
Cable Jacket Color: Black
Cable Jacket Material: PUR
Operating Temperature: -20 to +80° C

Environmental

Protection: IP67



19 Pole (Female View)	Female Straight		Female Right Angle	
	Engineering No.	Standard Order No.	Engineering No.	Standard Order No.
	303000P80M050	130008-0303	303001P80M050	130008-0315

Note: Sales drawings for all standard order numbers are available on molex.com

19 Pole (Female View)	Straight-to-Straight	
	Engineering No.	Standard Order No.
	333030P80M050	130012-0339

Configuration Code*
Build-a-Part Number

Meters	Length	Code
	2	M020
5	M050	
10	M100	

303000P80M0501

Coupling Nut Option
Stainless Steel 1

Orientation Code
 Straight female 000
 Right angle female 001
 Straight male 006
 Right angle male 007
 Straight female-to-straight male 030
 Right angle female-to-straight male 031
 Straight female-to-right angle male 032
 Right angle female-to right angle male 033

*Once an engineering number is created using the configuration code, consult Molex tech support for information regarding any part numbers.

Brad® Mini-Change® C-Size 19-pole Receptacles

130015
Female, Male
Threaded



Features and Benefits

- 18 AWG power and 22 AWG control conductors
- Oil and abrasion resistant polyurethane (PUR) jacket

Electrical

Current per Contact: 3.0A/2.0A
Voltage: 300V AC/DC

Mechanical

Wire Size: 18/22 AWG

Physical

Connector Face: PVC
Connector Body: PVC
Contact: Brass with Gold over Nickel plating
Coupling Nut: Black epoxy-coated Zinc
Cable Jacket Color: Black
Cable Jacket Material: PUR
Operating Temperature: -20 to +80° C

Environmental

Protection: IP67

19 Pole (Female View)	Straight	
	Engineering No.	Standard Order No.
	3R3N30E80C300	130015-0098

19 Pole (Male View)	Straight	
	Engineering No.	Standard Order No.
	3R3N36E80C300	130015-0109

Note: Sales drawings for all standard order numbers are available on molex.com

Configuration Code*
Build-a-Part Number

	Length	Code
Centimeters	30	C300
Meters	2	M020

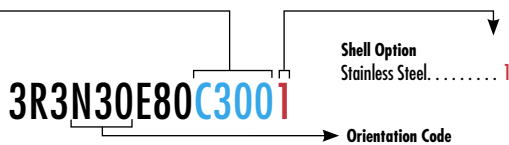

Orientation Code

*Once an engineering number is created using the configuration code, consult Molex tech support for information regarding any part numbers.

Brad® Mini-Change® C-Size Accessories

- Features and Benefits**
- Protects connector from dust and moisture

**Environmental
Protection: IP67**

130201

Closure Cap and Threaded Union

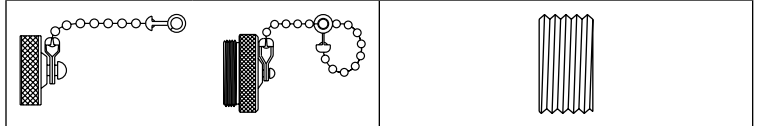

Product Name	Description	Engineering No.	Standard Order No.	Engineering No.	Standard Order No.
Closure Cap	1 1/8"-16UN-2B Internal Thread, Anodized Aluminum, with Steel Bead Chain	65-0105	130201-1120		
	1 1/8"-16UN-2A External Thread, Anodized Aluminum, with Steel Bead Chain	65-0104	130201-1118		
Threaded Union	Adapter, 1 1/8"-16UN-2A External Thread, Anodized Aluminum			55-0496	130201-1228

Note: Sales drawings for all standard order numbers are available on molex.com

Brad® M23 Signal and Power Connectors

M23

Brad® M23 connectors and receptacles for signal and power applications meet stringent requirements for reliability and performance in the harshest of industrial environments.

M23 Signal Connectors include field-attachable, male and female cable connectors and receptacles from 6-pole to 19-pole in both straight and right-angled versions. Designed to accommodate a broad range of cable outer diameters and receptacles, M23 connectors guarantee high flexibility in front- and back-mounting applications.

Inserts are available with solder or crimp contacts. The integrated locking clip secures the contacts in the inserts. Assembly and disassembly are easily performed without the need for special assembly tools.

M23 Power Connectors are designed for power applications up to 28.0A. Molex offers field-attachable cable connectors and receptacles in 6-pole (5+PE) and 8-pole (4+3+PE) versions. Applying the same modular design as the signal connectors, both pole counts can be used in straight and right-angled versions that are easy to assemble and disassemble with no special tools required.

Crimp contacts are available with different crimp ranges. Female contacts with integrated springs assure exceptional electrical performance with ultimate contact reliability in both signal and power product ranges.

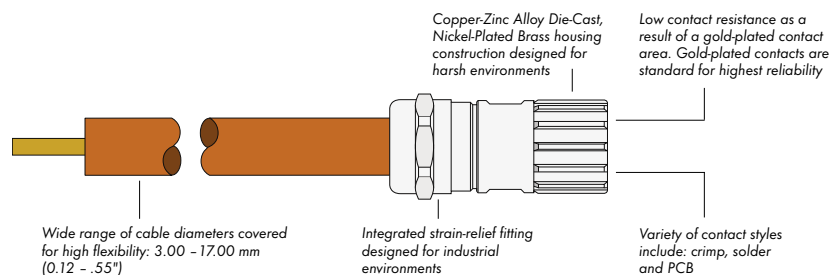

Features and Benefits

Signal Connector

- Cable assembly and shielding are performed in one simple step for user-friendly assembly
- Clipped-on, strain-relief insert prevents cable rotation
- Flexible, EMC O-ring guarantees reliable EMC protection
- Radial-encompassing spring contacts assure low plug-in resistance and high-mating cycles
- Integrated locking clip secures the contact in the insert and allows for easy assembly and disassembly

Power Connector

- Modular design means the same insert is used for all housings
- Integrated locking clip allows for quick assembly and disassembly
- Plug-and-play design allows complete assembly and disassembly without special tools
- Gold-plated contact area features durable, corrosion-resistant plating that maintains low electrical resistance through the mate/unmate cycles
- Integrated strain-relief fitting prevents cable rotation

Applications

- Servo drives
- Encoders
- Resolvers
- Active and passive I/O boxes
- Safety applications
- Safety switches
- Safety door handles
- Harsh commercial
- Solar panel wiring systems
- Home Run connectivity for MPIS

Brad[®] M23 Signal Field Attachable Connectors

120230

Female Crimp-Style Contacts Straight, Right Angle



Features and Benefits

- Cable assembly and shielding in one assembly step
- Clipped-on strain-relief insert prevents cable rotation
- Flexible EMC-O-Ring guarantees reliable EMC-protection
- Radial-encompassing spring contacts assure low plug-in resistance and high-mating cycles
- Integrated locking clip secures the contact in the insert and allows easy assembly and disassembly

Physical

Housing: Copper-Zinc alloy, die-casting
 Housing Surface: Nickel-plated Brass
 Cable Diameter Range: 3.00 to 17.00mm (0.12 to 0.55")
 Inserts (for contacts):
 Thermoplastic polyamid PA 6 (Nylon 6/6), PBT fire protection class V-0
 Contacts: Brass alloy
 Contact Type: Crimp, solder, dip-solder (PCB)
 Contact Surface at Point of Contact:
 Nickel- and Gold-plated (0.25µm)
 Minimum Mating Cycles: >1000
 Seals/O-Rings: Buna-N standard
 Operating Temperature: -40 to +125° C

Environmental

Protection: IP67 per EN 60625 (connected)
 NEMA Rating: 4x

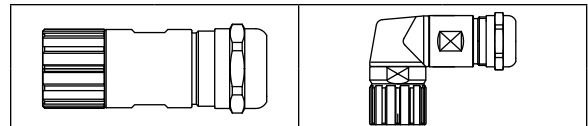

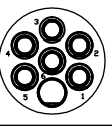
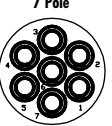
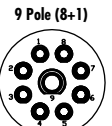
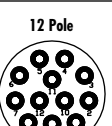
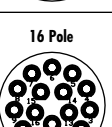
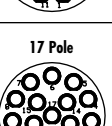
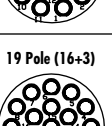
Poles	Max. Current per Contact	Max. Voltage	Cable Diameter*	Crimp Range	Female Straight		Female Right Angle	
					Engineering No.	Standard Order No.	Engineering No.	Standard Order No.
6 Pole 	20.0A	300V	7.00-12.00mm (.276-.472")	0.75-2.5mm ²	KAS6S00-405	120230-0005		
7 Pole 	20.0A	300V	7.00-12.00mm (.276-.472")	0.75-2.5mm ²	KAS7S00-405	120230-0014		
	8.0A						KAS7S01-405	120230-0072
9 Pole (8+1) 	8=8.0A, 1=20.0A	300V	7.00-12.00mm (.276-.472")	0.34-1.00mm ² /0.75-2.5mm ²	KAS9S00-425	120230-0023	KAS9S01-425	120230-0078
12 Pole 	8.0A	300V	7.00-12.00mm (.276-.472")	0.34-1.00mm ²	KASC00-025	120230-0032	KASC01-025	120230-0084
16 Pole 	8.0A	150V	7.00-12.00mm (.276-.472")	0.34-1.00mm ²	KASH00-025	120230-0041	KASH01-025	120230-0090
17 Pole 	8.0A	150V	7.00-12.00mm (.276-.472")	0.34-1.00mm ²	KASJS00-025	120230-0050	KASJS01-025	120230-0096
19 Pole (16+3) 	16=8.0A, 3=10.0A	150V	7.00-12.00mm (.276-.472")	0.34-1.00mm ² /0.56-1.00mm ²			KALS01-225	120230-0102

Note: Sales drawings for all standard order numbers are available on molex.com

*Cable diameters 3.00-7.00mm and 11.00-17.00mm also available. Contact Molex for more information.

Brad® M23 Signal Field Attachable Connectors

120230 Male Crimp-Style Contacts Straight



Features and Benefits

- Cable assembly and shielding in one assembly step
- Clipped-on strain-relief insert prevents cable rotation
- Flexible EMC-O-Ring guarantees reliable EMC-protection
- Radial-encompassing spring contacts assure low plug-in resistance and high-mating cycles
- Integrated locking clip secures the contact in the insert and allows easy assembly and disassembly

Physical

Housing: Copper-Zinc alloy, die-casting
 Housing Surface: Nickel-plated Brass
 Cable Diameter Range: 3.00 to 17.00mm (0.12 to 0.55")
 Inserts (for contacts):
 Thermoplastic polyamid PA 6 (Nylon 6/6), PBT fire protection class V-0
 Contacts: Brass alloy
 Contact Type: Crimp, solder, dip-solder (PCB)
 Contact Surface at Point of Contact:
 Nickel- and Gold-plated (0.25µm)
 Minimum Mating Cycles: >1000
 Seals/O-Rings: Buna-N standard
 Operating Temperature: -40 to +125° C

Environmental

Protection: IP67 per EN 60625 (connected)
 NEMA Rating: 4x

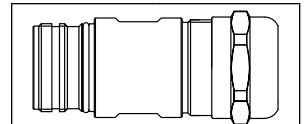

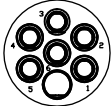
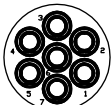
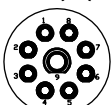
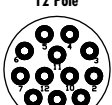
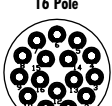
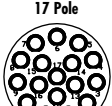
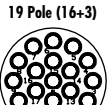
Poles	Max. Current per Contact	Max. Voltage	Cable Diameter*	Crimp Range	Engineering No.	Standard Order No.
6 Pole 	20.0A	300V	7.00-12.00mm (.276-.472")	0.75-2.50mm ²	KAS6S06-405	120230-0110
7 Pole 	20.0A	300V	7.00-12.00mm (.276-.472")	0.75-2.50mm ²	KAS7S06-405	120230-0119
9 Pole (8+1) 	8=8.0A, 1=20.0A	300V	7.00-12.00mm (.276-.472")	0.14-1.00mm ² /0.75-2.50mm ²	KAS9S06-415	120230-0128
12 Pole 	8.0A	300V	7.00-12.00mm (.276-.472")	0.14-1.00mm ²	KASC506-015	120230-0137
16 Pole 	8.0A	150V	7.00-12.00mm (.276-.472")	0.14-1.00mm ²	KASH506-015	120230-0146
17 Pole 	8.0A	150V	7.00-12.00mm (.276-.472")	0.14-1.00mm ²	KASJS06-015	120230-0155
19 Pole (16+3) 	16=8.0A, 3=10.0A	150V	7.00-12.00mm (.276-.472")	0.14-1.00mm ² / 0.14-1.00mm ²	KASLS06-115	120230-0164

Note: Sales drawings for all standard order numbers are available on molex.com
 *Cable diameters 3.00-7.00mm and 11.00-17.00mm also available. Contact Molex for more information.

Brad® M23 Signal Receptacles

120231 Female Crimp-Style Contacts Straight Front Panel Mount



Features and Benefits

- Cable assembly and shielding in one assembly step
- Clipped-on strain-relief insert prevents cable rotation
- Flexible EMC-O-Ring guarantees reliable EMC-protection
- Radial-encompassing spring contacts assure low plug-in resistance and high-mating cycles
- Integrated locking clip secures the contact in the insert and allows easy assembly and disassembly



Physical

Housing: Copper-Zinc alloy, die-casting
 Housing Surface: Nickel-plated Brass
 Cable Diameter Range: 3.00 to 17.00mm (0.12 to 0.55")
 Inserts (for contacts):
 Thermoplastic polyamid PA 6 (Nylon 6/6), PBT fire protection class V-0
 Contacts: Brass alloy
 Contact Type: Crimp, solder, dip-solder (PCB)
 Contact Surface at Point of Contact:
 Nickel- and Gold-plated (0.25µm)
 Minimum Mating Cycles: >1000
 Seals/O-Rings: Buna-N standard
 Operating Temperature: -40 to +125° C

Environmental

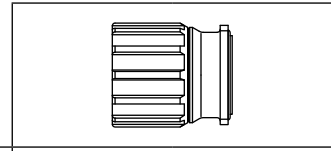
Protection: IP67 per EN 60625 (connected)
 NEMA Rating: 4x

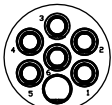
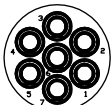
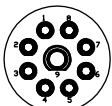
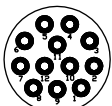
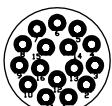
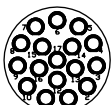

Poles	Max. Current per contact	Max. Voltage	Mounting Type	Mounting Thread	Crimp Range	Straight	
						Engineering No.	Standard Order No.
6 Pole 	20.0A	300V	Flange-Mount	Flange 4x0 3.2mm	0.75-2.5mm ²	KRS6G20-403	120231-0002
7 Pole 	20.0A	300V	Flange-Mount	Flange 4x0 3.2mm	0.75-2.5mm ²	KRS7G20-403	120231-0005
9 Pole (8+1) 	8 = 8.0A 1 = 20.0A	300V	Flange-Mount	Flange 4x0 3.2mm	0.54-2.1mm ² / 0.75-2.5mm ²	KRS9G20-423	120231-0008
12 Pole 	8.0A	300V	Flange-Mount	Flange 4x0 3.2mm	0.34-1.0mm ²	KRSCG20-023	120231-0011
16 Pole 	8.0A	150V	Flange-Mount	Flange 4x0 3.2mm	0.34-1.0mm ²	KRSHG20-023	120231-0014
17 Pole 	8.0A	150V	Flange-Mount	Flange 4x0 3.2mm	0.34-1.0mm ²	KRSJG20-023	120231-0017
19 Pole (16+3) 	16 = 8.0A 3 = 10.0A	150V	Flange-Mount	Flange 4x0 3.2mm	0.34-1.0mm ² / 0.56-1.0mm ²	KRSLG20-223	120231-0020

Note: Sales drawings for all standard order numbers are available on molex.com

Brad® M23 Signal Receptacles

120231

Male Crimp-Style Contacts Straight, Right Angle Front Panel Mount



Features and Benefits



- Cable assembly and shielding in one assembly step
- Clipped-on strain-relief insert prevents cable rotation
- Flexible EMC-O-Ring guarantees reliable EMC-protection
- Radial-encompassing spring contacts assure low plug-in resistance and high-mating cycles
- Integrated locking clip secures the contact in the insert and allows easy assembly and disassembly

Physical

Housing: Copper-Zinc alloy, die-casting
 Housing Surface: Nickel-plated Brass
 Cable Diameter Range: 3.00 to 17.00mm (0.12 to 0.55")
 Contact Inserts:
 Thermoplastic Polyamid PA 6 (Nylon 6/6),
 PBT fire protection class V-0
 Contacts: Brass alloy
 Contact Type: Crimp, solder, dip-solder (PCB)
 Contact Surface at Point of Contact:
 Nickel- and Gold-plated (0.25µm)
 Minimum Mating Cycles: >1000
 Seals/O-Rings: Buna-N standard
 Operating Temperature: -40 to +125° C

Environmental

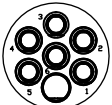
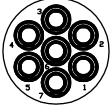
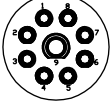
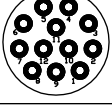
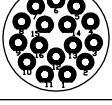
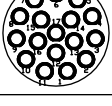
Protection: IP67 per EN 60625 (connected)
 NEMA Rating: NEMA 4x

Poles (Male View)	Max. Current per Contact	Max. Voltage	Mounting Type	Mounting Thread	Crimp Range	Straight		Right Angle*	
						Engineering No.	Standard Order No.	Engineering No.	Standard Order No.
6 Pole 	20.0A	300V	Flange Mount	Flange 4x3.20mm	0.75-2.50mm ²	KRS6G26-4031	120231-0023	KRS6G27-4012	120231-0044
7 Pole 	20.0A	300V	Flange Mount	Flange 4x3.20mm	0.75-2.50mm ²	KRS7G26-4031	120231-0026	KRS7G27-4012	120231-0047
9 Pole (8+1) 	8 = 8.0A 1 = 20.0A	300V	Flange Mount	Flange 4x3.20mm	0.14-1.00mm ² / 0.75-2.50 mm ²	KRS9G26-4131	120231-0029	KRS9G27-4112	120231-0050
12 Pole 	8.0A	300V	Flange Mount	Flange 4x3.20mm	0.14-1.00mm ² / 0.75-2.50 mm ²	KRSCG26-0131	120231-0032	KRSCG27-0112	120231-0053
16 Pole 	8.0A	150V	Flange Mount	Flange 4x3.20mm	0.14-1.00mm ² / 0.75-2.50 mm ²	KRSHG26-0131	120231-0035	KRSHG27-0112	120231-0056
17 Pole 	8.0A	150V	Flange Mount	Flange 4x3.20mm	0.14-1.00mm ² / 0.75-2.50 mm ²	KRSJG26-0131	120231-0038	KRSJG27-0112	120231-0059
19 Pole (16+3) 	16 = 18.0A 3 = 10.0A	150V	Flange Mount	Flange 4x3.20mm	0.14-1.00mm ² /0.14-1.00mm ²	KRSLG26-1131	120231-0041	KRSLG27-1112	120231-0062

Note: Sales drawings for all standard order numbers are available on molex.com
 *Receptacle flange mount rotatable

Brad® M23 Signal Receptacles

120231 Male Crimp-Style Contacts Straight Back Panel Mount



Features and Benefits

- Cable assembly and shielding in one assembly step
- Clipped-on strain-relief insert prevents cable rotation
- Flexible EMC-O-Ring guarantees reliable EMC-protection
- Radial-encompassing spring contacts assure low plug-in resistance and high-mating cycles
- Integrated locking clip secures the contact in the insert and allows easy assembly and disassembly



Physical

Housing: Copper-Zinc alloy, die-casting
 Housing Surface: Nickel-plated Brass
 Cable Diameter Range: 3.00 to 17.00mm (0.12 to 0.55")
 Contact Inserts:
 Thermoplastic Polyamid PA 6 (Nylon 6/6),
 PBT fire protection class V-0
 Contacts: Brass alloy
 Contact Type: Crimp, solder, dip-solder (PCB)
 Contact Surface at Point of Contact:
 Nickel- and Gold-plated (0.25µm)
 Minimum Mating Cycles: >1000
 Seals/O-Rings: Buna-N standard
 Operating Temperature: -40 to +125° C

Environmental

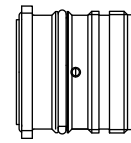
Protection: IP67 per EN 60625 (connected)
 NEMA Rating: NEMA 4x

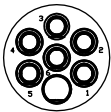
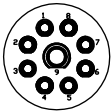
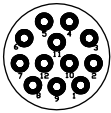

Poles (Male View)	Max. Current per Contact	Max. Voltage	Mounting Type	Mounting Thread	Crimp Range	Straight	
						Engineering No.	Standard Order No.
6 Pole 	20.0A	300V	Flange Mount	Flange 4xM3	0.75-2.50mm ²	KRS6G46-4041	120231-0066
7 Pole 	20.0A	300V	Flange Mount	Flange 4xM3	0.75-2.50mm ²	KRS7G46-4041	120231-0070
9 Pole (8+1) 	8 = 8.0A 1 = 20.0A	300V	Flange Mount	Flange 4xM3	0.14-1.00mm ² / 0.75-2.50 mm ²	KRS9G46-4141	120231-0074
12 Pole 	8.0A	300V	Flange Mount	Flange 4xM3	0.14-1.00mm ²	KRSCG46-0141	120231-0078
16 Pole 	8.0A	150V	Flange Mount	Flange 4xM3	0.14-1.00mm ²	KRSHG46-0141	120231-0082
17 Pole 	8.0A	150V	Flange Mount	Flange 4xM3	0.14-1.00mm ²	KRSJG46-0141	120231-0086
19 Pole (16+3) 	16 = 18.0A 3 = 10.0A	150V	Flange Mount	Flange 4xM3	0.14-1.00mm ² / 0.14-1.00mm ²	KRSLG46-1141	120231-0090

Note: Sales drawings for all standard order numbers are available on molex.com

Brad® M23 Signal Receptacles

120231

Male Crimp-Style Contacts
Straight
Back Panel Mount



Features and Benefits

- Cable assembly and shielding in one assembly step
- Clipped-on strain-relief insert prevents cable rotation
- Flexible EMC-O-Ring guarantees reliable EMC-protection
- Radial-encompassing spring contacts assure low plug-in resistance and high-mating cycles
- Integrated locking clip secures the contact in the insert and allows easy assembly and disassembly

Physical

Housing: Copper-Zinc alloy, die-casting
 Housing Surface: Nickel-plated Brass
 Cable Diameter Range: 3.00 to 17.00mm (0.12 to 0.55")
 Contact Inserts:
 Thermoplastic Polyamid PA 6 (Nylon 6/6),
 PBT fire protection class V-0
 Contacts: Brass alloy
 Contact Type: Crimp, solder, dip-solder (PCB)
 Contact Surface at Point of Contact:
 Nickel- and Gold-plated (0.25µm)
 Minimum Mating Cycles: >1000
 Seals/O-Rings: Buna-N standard
 Operating Temperature: -40 to +125° C

Environmental

Protection: IP67 per EN 60625 (connected)
 NEMA Rating: NEMA 4x

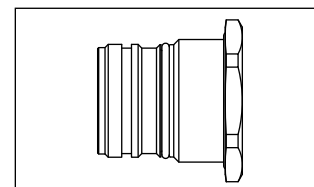

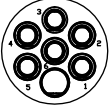
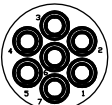
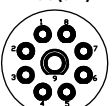
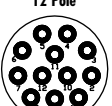
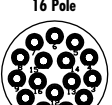
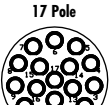
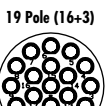
Poles (Male View)	Max. Current per Contact	Max. Voltage	Mounting Type	Mounting Thread	Crimp Range	Straight	
						Engineering No.	Standard Order No.
6 Pole 	20.0A	300V	Flange Mount	Single Hole	0.75-2.50mm ²	KRS6P46-400	120231-0094
7 Pole 	20.0A	300V	Flange Mount	Single Hole	0.75-2.50mm ²	KRS7P46-400	120231-0098
9 Pole (8+1) 	8 = 8.0A 1 = 20.0A	300V	Flange Mount	M25x1.5	0.14-1.00mm ² / 0.75-2.50 mm ²	KRS9P46-410	120231-0102
12 Pole 	8.0A	300V	Flange Mount	M25x1.5	0.14-1.00mm ²	KRSCP46-010	120231-0106
16 Pole 	8.0A	150V	Flange Mount	M25x1.5	0.14-1.00mm ²	KRSHP46-010	120231-0110
17 Pole 	8.0A	150V	Flange Mount	M25x1.5	0.14-1.00mm ²	KRSJP46-010	120231-0114
19 Pole (16+3) 	16 = 18.0A 3 = 10.0A	150V	Flange Mount	M25x1.5	0.14-1.00mm ² / 0.14-1.00mm ²	KRSLP46-110	120231-0118

Note: Sales drawings for all standard order numbers are available on molex.com
 *Receptacle flange mount rotatable

Brad® M23 Signal Single-Ended Molded Cordsets

120094

**Female Straight
Female Right Angle-to-Pigtail**



Features and Benefits

- 12- and 19-pole versions available
- IP67 rated for harsh environments
- Offered with PUR cables for moderate flexing and for environments encountering cutting fluids and oils

Electrical

Voltage: 63V AC/DC max.
Current: 6.0A max.

Mechanical

Wire Size: 18/22 AWG

Physical

Connector Body: TPU
Cable Jacket: PUR
Keyway: None
Connector End A: M23
Connector End B: Pigtail
Contact: Copper with Gold over Nickel plating
Coupling Nut: Nickel-plated Brass
Cable Length: 10.0m (32.81")
Cable Jacket Color: Black
Operating Temperature: -25 to +90° C

Environmental

Protection: IP67
NEMA Rating: NEMA 6

Poles (Female View)	Cable Diameter	Female Straight		Female Right Angle-to-Pigtail	
		Engineering No.	Standard Order No.	Engineering No.	Standard Order No.
		<p>12 Pole</p>	9.40mm (.370")	K02100P80M100	120094-5022
<p>19 Pole</p>	11.43mm (.450")	K03000P80M100	120094-5003	K03001P80M100	120094-0044

Note: Sales drawings for all standard order numbers are available on molex.com

Configuration Code*
Build-a-Part Number

	Length	Code
Meters	2	M020
	5	M050
	10	M100

K02100P80M100

*Once an engineering number is created using the configuration code, consult Molex tech support for information regarding any part numbers.

Brad® M23 Power Field Attachable Connectors

120233

**Female Crimp-Style Contacts
Straight, Right Angle**



Features and Benefits

- Modularity—same insert for all housings
- The integrated locking clip allows quick assembly
- Complete assembly and disassembly without special tools
- Lowest contact resistance as a result of a Gold-plated contact area
- Integrated strain-relief fitting

Physical

Housing: Copper-Zinc alloy, die-casting

Housing Surface: Nickel-plated Brass

Contact Inserts:

Thermoplastic Polyamid PA 6 (Nylon 6/6),

PBT fire protection class 94V-0

Contacts: Brass alloy

Type of Contacts: Crimp

Contact Surface at Point of Contact:

Nickel- and Gold-plated (0.25µm)

Minimum Mating Cycles: >1000

Seals/O-Rings: Buna-N standard

Operating Temperature: -40 to 125° C

Environmental

Protection: IP67 per EN 60625 (connected)

NEMA Rating: NEMA 4x

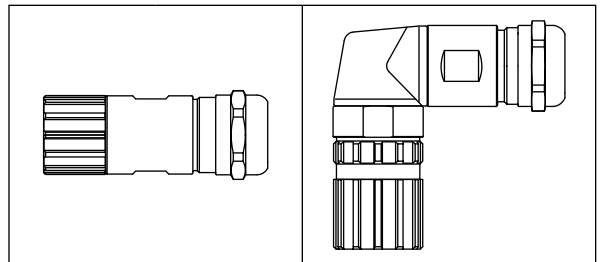

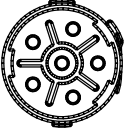
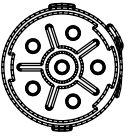
Poles (Female View)	Max. Current per Contact	Max. Voltage	Crimp Range	Female Straight		Female Right Angle	
				Engineering No.	Standard Order No.	Engineering No.	Standard Order No.
6 (5+PE) 	28.0A	800V	0.75-2.50mm ²	KAP6S00-105	120233-0001	KAP6S01-105	120233-0009
8 (4+3+PE) 	4=8.0A, 4=28.0A	4=300V, 4=800V	0.25-1.00mm ² /0.75-2.5mm ²	KAP8S00-115	120233-0005	KAP8S01-115	120233-0013

Note: Sales drawings for all standard order numbers are available on molex.com

Brad® M23 Power Field Attachable Connectors

120233 Male Crimp-Style Contacts Straight



Features and Benefits

- Modularity—same insert for all housings
- The integrated locking clip allows quick assembly
- Complete assembly and disassembly without special tools
- Lowest contact resistance as a result of a Gold-plated contact area
- Integrated strain-relief fitting

Physical

Connector Body: Nylon
Keyway: None
Contact: Brass with Gold over Nickel plating
Operating Temperature: -40 to +125° C

Environmental

Protection: IP67

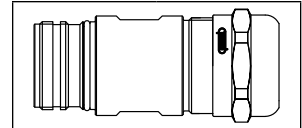

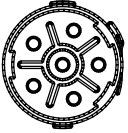
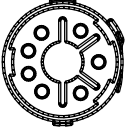
Poles	Max. Current per Contact	Max. Voltage	Cable Diameter	Crimp Range	Engineering No.	Standard Order No.
6 Pole (5+PE) 	28.0A	800V	7.00-12.00mm (.276-.472")	0.25-1.00mm	KAP6S06-105	120233-0017
8 Pole (4+3+PE) 	4 = 8.0A 4 = 28.0A	4 = 300V 4 = 800V	7.00-12.00mm (.276-.472")	0.75-2.50mm	KAP8S06-115	120233-0021

Note: Sales drawings for all standard order numbers are available on molex.com

Brad® M23 Power Connectors Receptacles

120234
Female Crimp-Style Contacts
Straight
Front Panel Mount



Features and Benefits

- Modularity—same insert for all housings
- The integrated locking clip allows quick assembly
- Complete assembly and disassembly without special tools
- Lowest contact resistance as a result of a Gold-plated contact area
- Integrated strain-relief fitting

Physical

Housing: Copper-Zinc alloy, die-casting
 Housing Surface: Nickel-plated Brass
 Inserts (for contacts):
 Thermoplastic polyamid PA 6 (Nylon 6/6), PBT fire protection class 94V-0
 Contacts: Brass alloy
 Type of Contacts: Crimp
 Contact Surface at Point of Contact:
 Nickel- and Gold-plated (0.25µm)
 Minimum Mating Cycles: >1000
 Seals/O-Rings: Buna-N standard
 Operating Temperature: -40 to 125° C

Environmental

Protection: IP67 per EN 60625 (connected)
 NEMA Rating: 4x

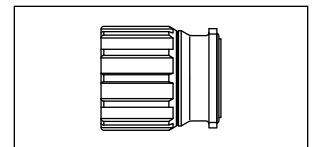

Poles	Max. Current per Contact	Max. Voltage	Panel Mount Style	Mounting Type	Mounting Thread	Crimp Range	Straight	
							Engineering No.	Standard Order No.
6 Pole (5+PE) 	28.0A	800V	Front Panel	Flange-Mount	Flange 4x0 3.2mm	0.75-2.5mm ²	KRP6G00-103	120234-0001
8 Pole (4+3+PE) 	4=8.0A, 4=28.0A	4=300V, 4=800V	Front Panel	Flange-Mount	Flange 4x0 3.2mm	0.25-1.00mm ² / .75-2.5mm ²	KRP8G00-113	120234-0003

Note: Sales drawings for all standard order numbers are available on molex.com

Brad® M23 Power Receptacles

120234

Male Crimp-Style Contacts Straight, Right Angle Front, Back Panel Mount



Features and Benefits

- Modularity—same insert for all housings
- The integrated locking clip allows quick assembly
- Complete assembly and disassembly without special tools
- Lowest contact resistance as a result of a Gold-plated contact area
- Integrated strain-relief fitting









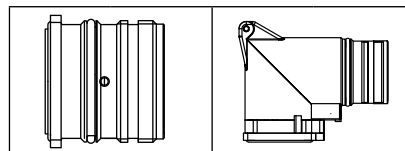

Physical

Housing: Copper-Zinc alloy, die-casting
 Housing Surface: Nickel-plated Brass
 Inserts (for contacts): Thermoplastic polyamid PA 6 (Nylon 6/6), PBT fire protection class 94V-0
 Contacts: Brass alloy
 Type of Contacts: Crimp
 Contact Surface at Point of Contact: Nickel- and Gold-plated (0.25µm)
 Minimum Mating Cycles: >1000
 Seals/O-Rings: Buna-N standard
 Operating Temperature: -40 to 125° C

Environmental

Protection: IP67 per EN 60625 (connected)
 NEMA Rating: 4x



Poles	Max. Current per Contact	Max. Voltage	Panel Mount Style	Mounting Type	Mounting Thread	Crimp Range	Rotatable	Straight		Right Angle	
								Engineering No.	Standard Order No.	Engineering No.	Standard Order No.
6 Pole (5+PE) 	28.0A	800V	Front Panel	Flange-Mount	Flange 4xØ 3.20mm	0.75-2.50mm ²	No	KRP6G06-103	120234-0005		
8 Pole (4+3+PE) 	4=8.0A, 4=28.0A	4=300V, 4=800V	Front Panel	Flange-Mount	Flange 4xØ 3.20mm	0.25-1.00mm ² / 0.75-2.5mm ²		KRP8G06-113	120234-0007		
6 Pole (5+PE) 	28.0A	800V	Front Panel	Flange 25.00 x 25.00mm	Flange 4xØ 2.70mm	0.75-2.50mm ²	Yes			KRP6G07-1012	120234-0009
8 Pole (4+3+PE) 	4=8.0A, 4=28.0A	4=300V, 4=800V	Front Panel	Flange 25.00 x 25.00mm	Flange 4xØ 2.70mm	0.25-1.00mm ² / 0.75-2.5mm ²				KRP8G07-1112	120234-0011
6 Pole (5+PE) 	28.0A	800V	Front Panel	Flange 28.00 x 28.00mm	Flange 4xØ 3.20mm	0.75-2.50mm ²				KRP6G07-1052	120234-0013
8 Pole (4+3+PE) 	4=8.0A, 4=28.0A	4=300V, 4=800V	Front Panel	Flange 28.00 x 28.00mm	Flange 4xØ 3.20mm	0.25-1.00mm ² / 0.75-2.5mm ²				KRP8G07-1152	120234-0015
6 Pole (5+PE) 	28.0A	800V	Back Panel	Flange-Mount	Flange 4xØ 3.20mm	0.75-2.50mm ²	No	KRP6G46-1031	120234-0017		
8 Pole (4+3+PE) 	4=8.0A, 4=28.0A	4=300V, 4=800V	Back Panel	Flange-Mount	Flange 4xØ 3.20mm	0.25-1.00mm ² / 0.75-2.5mm ²		KRP8G46-1131	120234-0019		
6 Pole (5+PE) 	28.0A	800V	Back Panel	Single Hole Mount	M25 x 1.50mm	0.75-2.50mm ²		KRP6P46-100	120234-0021		
8 Pole (4+3+PE) 	4=8.0A, 4=28.0A	4=300V, 4=800V	Back Panel	Single Hole Mount	M25 x 1.50mm	0.25-1.00mm ² / 0.75-2.5mm ²		KRP8P46-110	120234-0023		

Note: Sales drawings for all standard order numbers are available on molex.com

Brad® M23 Power and Signal Tools and Accessories

120155



Description	Power / Signal	Gender	Engineering No.	Standard Order No.
Crimp Tool	Power		KP-TOOL-01	120155-0017
	Signal		KS-TOOL-01	120155-0012
Locator	Power	Male	KP-LOC-01	120155-0018
		Female	KP-LOC-02	120155-0019
	Signal	Male	KS-LOC-01	120155-0013
		Female	KS-LOC-02	120155-0014
Assembly Tool	Signal		KS-TOOL-02	120155-0015
Adapter Flange	Signal/Power		KA-FLANGE	120155-0016

mPm® DIN Cordset Family

DIN

FIELD ATTACHABLE

The mPm range of connectors conform to Industry Standard EN 175301-803 (formerly DIN 43650). This is the standard for a series of electrical connectors, which are commonly used with solenoid valves (especially those used on hydraulic and pneumatic valves). The new generation of Molex DIN connectors provides customers with unsurpassed sealing performance, easier assembly and mounting and lower applied costs.

The connector has an external nut to provide greater and consistent torque which ensures good cable retention and high reliability. Together with the integrated front gasket, Molex DIN connectors achieve a sealing performance from dust and water to IP67. Cable retention force is increased by up to 115% when compared with traditional internal nut designs. This innovative new design reduces the number of components in the connector, making customer assembly and secure mounting, easier and quicker.

Traditional mPm connectors are supplied to the customer pre-assembled, requiring disassembly before terminating the cable. The new generation of connectors is supplied in single set, or bulk components reducing disassembly time and reducing cost. The connectors can accommodate PG9 and PG11 cable and up to 9.00mm cable outer diameter and since one size fits all the customer can reduce their connector inventory. The result is a higher performance and lower overall cost solution. To further reduce labor, pre-terminated and overmolded DIN connectors are also available in stand lengths.

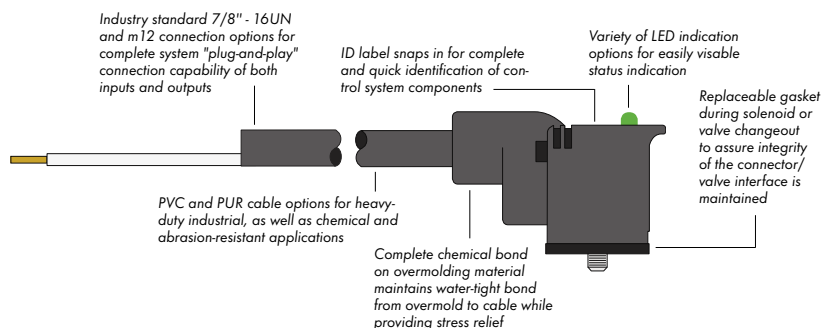

Overmolded with LED

MOLDED CABLE

Our connectors with molded-in cable are suitable for use with most types of solenoid. They offer a fast and efficient method of connection resulting in greatly reduced installation time and cost. They can be supplied with or without integral LED indicators and suppression circuits. A diagram is printed on each connector with circuit to allow for easy user identification.



Overmolded With LED

Overmolded without LED



Field Attachable With LED



Field Attachable without LED

Brad® mPm® Field Attachable DIN Valve Connectors

121201/121207

Form A External Thread Non-Electronic, Electronic



Features and Benefits

- IP67 rated for waterproofing
- Conforms to industry standard EN175301-803
- Accommodates a range of cable diameters
- Product supplied in ready-to-use condition
- Integrated gaskets within housing

Reference Information

UL Listed, File E218123 (available upon request)

Electrical

Max. Current: 16.0A
Contact Resistance: ≤4 milliohms max.
Insulation Resistance: 100 Megaohms min.
Max. Conductor: 1.50mm²/16 AWG

Mechanical

Insertion and Withdrawal Force: 2+PE ≤ 60N

Physical

Durability (min.): 50 cycles
Contact Area: Silver
Solder Tail Area: Silver
Operating Temperature:
Nitrile Rubber (NBR) Gasket — -40 to +90° C
Silicone Gasket — -40 to +125° C
Cable Range: 4.00-9.00mm
Contact Distance: C28 (Non-Electronic)—18.00mm (.709")
S28 (Electronic)—18.00mm (.709")
Poles: 2—2-pole
3—3-pole
Material and Housing Color: G—PA6, Gray
N—PA6, Black
T—Transparent
Ground Position: 0—Unmounted
2—H12
3—H3
6—H6
9—H9

Physical (continued)

Screw and Gasket:
R—Integrated NBR Gasket and IP67 Screw
S—Integrated Silicon Gasket and IP67 Screw
Non-Standard Packaging:
CN—Bulk Pack Unmounted
SN—Bulk Pack Mounted
Voltage, LED Color (Electronic):
Red LED: 1—12V
2—24V
3—48V
4—115V
5—230V
Green LED: A—12V
B—24V
C—48V
D—115V
E—230V
Amber LED: G—12V
H—24V
K—48V
L—115V
M—230V
Circuit (Electronic): See Circuit Options on
mPm Available Circuits page

Environmental

Protection: IP67

Drawing	Pitch	Poles	Max. Current per Contact	Max. Voltage	Connector		Base		Type
					Engineering No.	Standard Order No.	Engineering No.	Standard Order No.	
	18.00mm	2	16.0A	250V AC 300V DC	C28200NOR	121201-0001	B202000N2	121012-0013	Non-Electronic
		3	16.0A	250V AC 300V DC	C28300NOR	121201-0002	B203000N2	121012-0019	Non-Electronic
For all Electronic part numbers, please use the Electronic Build-a-Part Number system in the Configuration Code below.									Electronic

Molex offers a wide range of additional related components such as adapters, splitters and dual-din overmolded connectors. For information regarding these products, please contact your local sales representative.

Configuration Code*
Build-a-Part Number

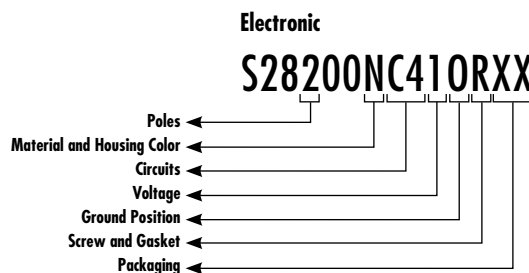
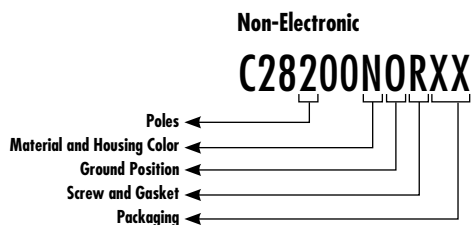

*Once an engineering number is created using the configuration code, consult Molex tech support for information regarding any part numbers.

Brad® mPm® Field Attachable DIN Valve Connectors

121202/121208

Form Industrial
External Thread
Non-Electronic, Electronic



Features and Benefits

- IP67 rated for waterproofing
- Conforms to industry standard EN175301-803
- Accommodates a range of cable diameters
- Product supplied in ready-to-use condition
- Integrated gaskets within housing

Reference Information

UL Listed, File E218123 (available upon request)

Electrical

Max. Current: Form A, B and Industrial—16.0A
Form C, Micro—10.0A
Contact Resistance: ≤4 milliohms max.
Insulation Resistance: 100 Megaohms min.
Max. Conductor: 1.50mm²/16 AWG

Mechanical

Insertion and Withdrawal Force: 2+PE ≤ 60N

Physical

Durability (min.): 50 cycles
Contact Area: Silver
Solder Tail Area: Silver
Operating Temperature:
Nitrile Rubber (NBR) Gasket — -40 to +90° C
Silicone Gasket — -40 to +125° C
Cable Range: 4.00-9.00mm
Contact Distance: C22 (Non-Electronic)—11.00mm (.433")
S22 (Electronic)—11.00mm (.433")
Poles: 2—2-pole + Ground
Material and Housing Color: G—PA6, Gray
N—PA6, Black
T—Transparent
Ground Position: 0—Unmounted
2—H12
3—H3
6—H6
9—H9

Physical (continued)

Screw and Gasket:
R—Integrated NBR Gasket and IP67 Screw
S—Integrated Silicon Gasket and IP67 Screw
Non-Standard Packaging:
CN—Bulk Pack Unmounted
SN—Bulk Pack Mounted
Voltage, LED Color (Electronic):
Red LED: 1—12V
2—24V
3—48V
4—115V
5—230V
Green LED: A—12V
B—24V
C—48V
D—115V
E—230V
Amber LED: G—12V
H—24V
K—48V
L—115V
M—230V
Circuit (Electronic): See Circuit Options on
mPm Available Circuits page

Environmental

Protection: IP67

Drawing	Pitch	Poles	Max. Current per Contact	Max. Voltage	Connector		Type
					Engineering No.	Standard Order No.	
	11.00mm	2	10.0A	250V AC 300V DC	C22200NOR	121202-0002	Non-Electronic
		For all Electronic part numbers, please use the Electronic Build-a-Part Number system in the Configuration Code below.					

Molex offers a wide range of additional related components such as adapters, splitters and dual-din overmolded connectors. For information regarding these products, please contact your local sales representative.

Configuration Code*
Build-a-Part Number

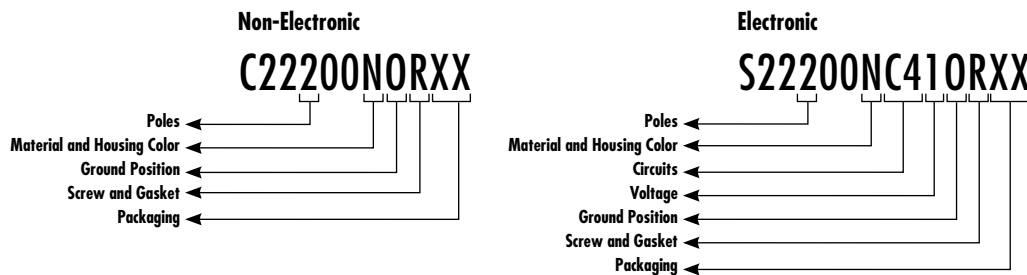

*Once an engineering number is created using the configuration code, consult Molex tech support for information regarding any part numbers.

Brad® mPm® Field Attachable DIN Valve Connectors

121203/121209

Form B External Thread Non-Electronic, Electronic



Features and Benefits

- IP67 rated for waterproofing
- Conforms to industry standard EN175301-803
- Accommodates a range of cable diameters
- Product supplied in ready-to-use condition

Reference Information

UL Listed, File E218123 (available upon request)

Electrical

Max. Current: 16.0A
Contact Resistance: ≤4 milliohms max.
Insulation Resistance: 100 Megaohms min.
Max. Conductor: 1.50mm²/16 AWG

Mechanical

Insertion and Withdrawal Force: 2+PE ≤ 60N

Physical

Durability (min.): 50 cycles
Contact Area: Silver
Solder Tail Area: Silver
Operating Temperature:
Nitrile Rubber (NBR) Gasket — -40 to +90° C
Silicone Gasket — -40 to +125° C
Cable Range: 4.00-9.00mm
Contact Distance: C92 (Non-Electronic)—10.00mm (.394")
S92 (Electronic)—10.00mm (.394")
Poles: 2—2-pole + Ground
Material and Housing Color: G—PA6, Gray
N—PA6, Black
T—Transparent
Ground Position: 0—Unmounted
2—H12
3—H3
6—H6
9—H9

Physical (continued)

Screw and Gasket:
T—Profile NBR and IP67 screw
U—Profile silicon and IP67 screw
Non-Standard Packaging:
CN—Bulk Pack Unmounted
SN—Bulk Pack Mounted
Voltage, LED Color (Electronic):
Red LED: 1—12V
2—24V
3—48V
4—115V
5—230V
Green LED: A—12V
B—24V
C—48V
D—115V
E—230V
Amber LED: G—12V
H—24V
K—48V
L—115V
M—230V
Circuit (Electronic): See Circuit Options on
mPm Available Circuits page

Environmental

Protection: IP67

Drawing	Pitch	Poles	Max. Current per Contact	Max. Voltage	Connector		Type
					Engineering No.	Standard Order No.	
	10.00mm	2	16.0A	250V AC 300V DC	C92200NOT	121203-0001	Non-Electronic
For all Electronic part numbers, please use the Electronic Build-a-Part Number system in the Configuration Code below.							Electronic

Configuration Code*
Build-a-Part Number

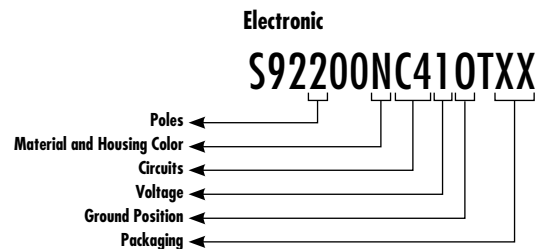
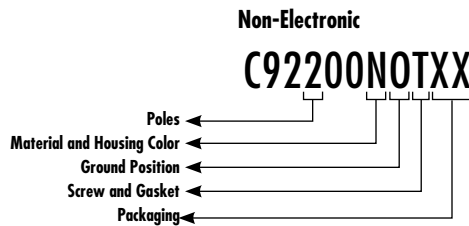

*Once an engineering number is created using the configuration code, consult Molex tech support for information regarding any part numbers.

Brad® mPm® Field Attachable DIN Valve Connectors

121203/121209

Form C External Thread Non-Electronic, Electronic



Features and Benefits

- IP67 rated for waterproofing
- Conforms to industry standard EN175301-803
- Accommodates a range of cable diameters
- Product supplied in ready-to-use condition

Reference Information

UL Listed, File E218123 (available upon request)

Electrical

Max. Current: 10.0A
Contact Resistance: ≤4 milliohms max.
Insulation Resistance: 100 Megaohms min.
Max. Conductor: 1.50mm²/16 AWG

Mechanical

Insertion and Withdrawal Force: 2+PE ≤ 60N

Physical

Durability (min.): 50 cycles
Contact Area: Silver
Solder Tail Area: Silver
Operating Temperature:
Nitrile Rubber (NBR) Gasket — -40 to +90° C
Silicone Gasket — -40 to +125° C
Cable Range: 3.00-5.50mm
Contact Distance: C25 (Non-Electronic)—8.00mm (.315")
S25 (Electronic)—8.00mm (.315")

Environmental

Protection: IP67 Poles: 2—2-pole
3—3-pole
Material and Housing Color: G—PA6, Gray
N—PA6, Black
T—Transparent
Ground Position: 0—Unmounted
2—H12
3—H3
6—H6
9—H9

Physical (continued)

Screw and Gasket:
T—Profile NBR and IP67 screw
U—Profile silicon and IP67 screw
Non-Standard Packaging:
CN—Bulk Pack Unmounted
SN—Bulk Pack Mounted
Voltage, LED Color (Electronic):
Red LED: 1—12V
2—24V
3—48V
4—115V
5—230V
Green LED: A—12V
B—24V
C—48V
D—115V
E—230V
Amber LED: G—12V
H—24V
K—48V
L—115V
M—230V
Circuit (Electronic): See Circuit Options on
mPm Available Circuits page

Drawing	Pitch	Poles	Max. Current per Contact	Max. Voltage	Connector		Base		Type
					Engineering No.	Standard Order No.	Engineering No.	Standard Order No.	
	8.00mm	2	10.0A	250V AC 300V DC	C25200NOT	121204-0001	B15200N2	121012-0009	Non-Electronic
		3	10.0A	250V AC 300V DC	C25300NOT	121204-0005	B15300N2	121012-0010	
		For all Electronic part numbers, please use the Electronic Build-a-Part Number system in the Configuration Code below.							

Molex offers a wide range of additional related components such as adapters, splitters and dual-din overmolded connectors. For information regarding these products, please contact your local sales representative.

Configuration Code*
Build-a-Part Number

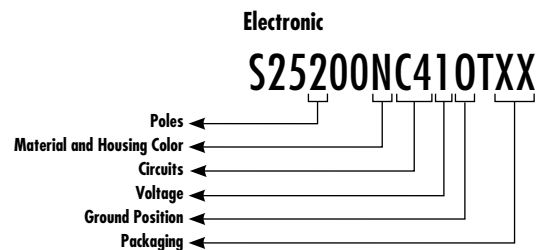
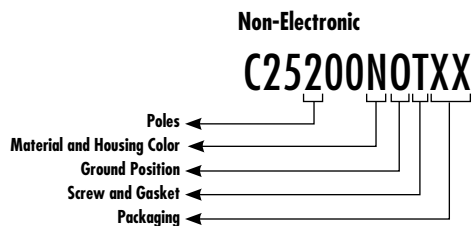

*Once an engineering number is created using the configuration code, consult Molex tech support for information regarding any part numbers.

Brad® mPm® Field Attachable DIN Valve Connectors

121205/121211

Form Micro External Thread Non-Electronic, Electronic



Features and Benefits

- IP67 rated for waterproofing
- Conforms to industry standard EN175301-803
- Accommodates a range of cable diameters
- Product supplied in ready-to-use condition

Reference Information

UL Listed, File E218123 (available upon request)

Electrical

Max. Current: 10.0A
Contact Resistance: ≤4 milliohms max.
Insulation Resistance: 100 Megaohms min.
Max. Conductor: 1.50mm²/16 AWG

Mechanical

Insertion and Withdrawal Force: 2+PE ≤ 60N

Physical

Durability (min.): 50 cycles
Contact Area: Silver
Solder Tail Area: Silver
Operating Temperature:
Nitrile Rubber (NBR) Gasket — -40 to +90° C
Silicone Gasket — -40 to +125° C
Cable Range: 3.00-5.50mm
Contact Distance: C29 (Non-Electronic)—9.40mm (.370")
S29 (Electronic)—9.40mm (.370")
Poles: 2—2-pole
3—3-pole
Material and Housing Color: G—PA6, Gray
N—PA6, Black
T—Transparent
Ground Position: 0—Unmounted
2—H12
3—H3
6—H6
9—H9

Physical (continued)

Screw and Gasket:
T—Profile NBR and IP67 screw
U—Profile silicon and IP67 screw
Non-Standard Packaging:
CN—Bulk Pack Unmounted
SN—Bulk Pack Mounted
Voltage, LED Color (Electronic):
Red LED: 1—12V
2—24V
3—48V
4—115V
5—230V
Green LED: A—12V
B—24V
C—48V
D—115V
E—230V
Amber LED: G—12V
H—24V
K—48V
L—115V
M—230V
Circuit (Electronic): See Circuit Options on
mPm Available Circuits page

Environmental

Protection: IP67

Drawing	Pitch	Poles	Max. Current per Contact	Max. Voltage	Connector		Base		Type
					Engineering No.	Standard Order No.	Engineering No.	Standard Order No.	
	9.40mm	2	10.0A	250V AC 300V DC	C29200NOT	121205-0001	B292000N2	121012-0102	Non-Electronic
		3	10.0A	250V AC 300V DC	C29300NOT	121205-0005			
For all Electronic part numbers, please use the Electronic Build-a-Part Number system in the Configuration Code below.									Electronic

Molex offers a wide range of additional related components such as adapters, splitters and dual-din overmolded connectors. For information regarding these products, please contact your local sales representative.

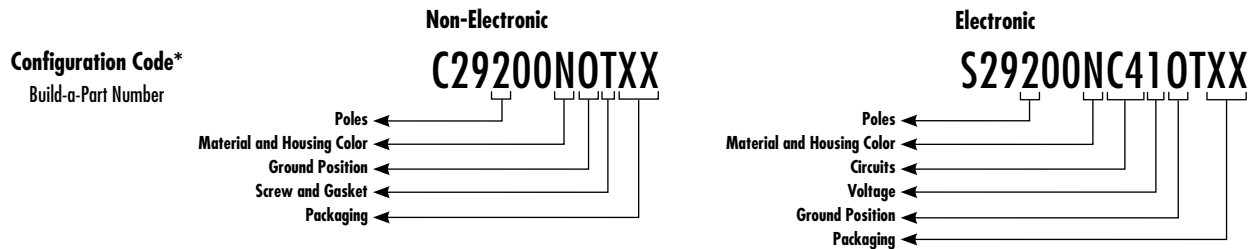

*Once an engineering number is created using the configuration code, consult Molex tech support for information regarding any part numbers.

Brad® mPm® Molded Cable DIN Valve Connectors

121040

Form A

Non-Electronic, Electronic



Features and Benefits

- DIN overmolded connector according to UNI EN 175301-803
- Available in Form A, Form B, Form C, Industrial and Micro
- Fully overmolded provides IP65 as standard but available with IP67
- Protection for harsh environments
- Available in array of configurations:
 - Large variety of cable types
 - H12 ground position standard (more orientations available upon request)
 - Black head standard (gray available upon request)
 - UL listed versions available
 - Large variety of integrated electronic circuit versions available
 - Different gasket available (flat, profile, self-retain)

Physical

Overmolding Material: Polypropylene
 Gasket: NBR black (silicon gasket available upon request)
 Contacts: Brass with Silver plating
 Wire: PVC (more available upon request)
 No. of Wires: 1—2 Wires
 2—2 Wires plus Earth
 3—3 Wires plus Earth
 Head Color: G—Gray
 N—Black
 A—Black (UL)
 B—Gray (UL)
 Cable Length (cm): 050—0.5m
 300—3.0m
 10K—10.0m
 Earth Pin Location: 1—H6/12 Double Earth
 6—H6
 2—H12

Gasket Screws:

- 1—NBR Profile Gasket Plus Fixing Screw
- 2—NBR Flat Gasket Plus Fixing Screw
- 3—Silicon Profile Gasket Plus Fixing Screw
- 4—Silicon Flat Gasket Plus Fixing Screw
- R—Integrated Gasket Plus Fixing Screw (IP67)

Physical (continued)

Voltage, LED Color (Electronic):
 Red LED: 1—12V
 2—24V
 3—48V
 4—115V
 5—230V
 Green LED: A—12V
 B—24V
 C—48V
 D—115V
 E—230V
 Amber LED: G—12V
 H—24V
 K—48V
 L—115V
 M—230V

Cable Cross Section Area: See Cable Options on Technical Features page

Cable Type: See Cable Options on Technical Features page
 Internal Circuit (Electronic): See Circuit Options on Circuits Available page

Environmental

Protection: IP65 (IP67 available upon request)
 Certifications: UL Listed, File E218123 (available upon request)

Drawing	Pitch	Poles	Cable Type	Max. Current per Contact	Max. Voltage	1.0m		2.0m		5.0m		10.0m		Type
						Engineering No.	Standard Order No.	Engineering No.	Standard Order No.	Engineering No.	Standard Order No.	Engineering No.	Standard Order No.	
	18.00mm	2	PVC H05 0.75mm ²	5.0A	250V AC 300V DC	E152N3N10011	121040-0140	E152N3N20011	121040-0159	E152N3N50011	121040-0589	E152N3N10K11	121040-0146	Non-Electronic
		3	PVC H05 0.75mm ²	5.0A	250V AC 300V DC	E153N3N10021	121040-0210	E153N3N20021	121040-0219	E153N3N50021	121040-0230	E153N3N10K21	121040-1257	
For all Electronic part numbers, please use the Electronic Build-a-Part Number system in the Configuration Code below.														Electronic

Configuration Code*

Build-a-Part Number

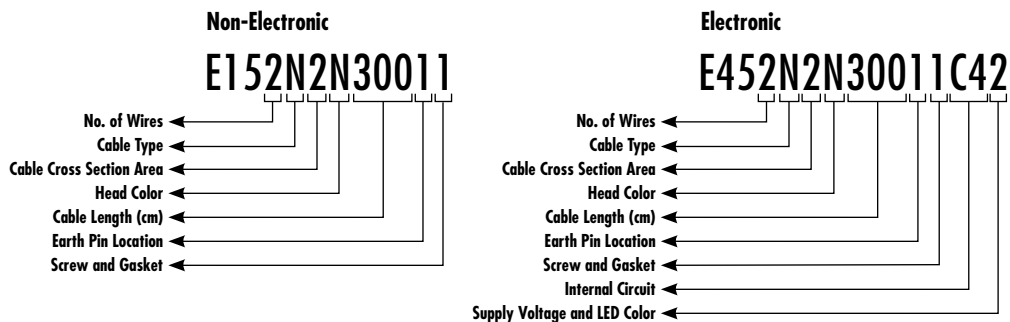

*Once an engineering number is created using the configuration code, consult Molex tech support for information regarding any part numbers.

Brad® mPm® Molded Cable DIN Valve Connectors

121040

Form Industrial
Non-Electronic, Electronic



Features and Benefits

- DIN overmolded connector according to UNI EN 175301-803
- Available in Form A, Form B, Form C, Industrial and Micro
- Fully overmolded provides IP65 as standard but available with IP67
- Protection for harsh environments
- Available in array of configurations:
 - Large variety of cable types
 - H12 ground position standard (more orientations available upon request)
 - Black head standard (gray available upon request)
 - UL listed versions available
 - Large variety of integrated electronic circuit versions available
 - Different gasket available (flat, profile, self-retain)

Physical

Overmolding Material: Polypropylene
 Gasket: NBR black (silicon gasket available upon request)
 Contacts: Brass with Silver plating
 Wire: PVC (more available upon request)
 No. of Wires: 1—2 Fill/Wires
 2—2 Fill plus Terra/2 Wires Plus Earth
 Head Color: G—Gray
 N—Black
 A—Black (UL)
 B—Gray (UL)
 Cable Length (cm): 050—0.5m
 300—3.0m
 10K—10.0m
 Earth Pin Location: 6—H6
 2—H12

Gasket Screws:

- 1— NBR Profile Gasket Plus Fixing Screw
- 2— NBR Flat Gasket Plus Fixing Screw
- 3— Silicon Profile Gasket Plus Fixing Screw
- 4— Silicon Flat Gasket Plus Fixing Screw
- R—Integrated Gasket Plus Fixing Screw (IP67)

Physical (continued)

Voltage, LED Color (Electronic):
 Red LED: 1—12V
 2—24V
 3—48V
 4—115V
 5—230V
 Green LED: A—12V
 B—24V
 C—48V
 D—115V
 E—230V
 Amber LED: G—12V
 H—24V
 K—48V
 L—115V
 M—230V

Cable Cross Section Area: See Cable Options on Technical Features page

Cable Type: See Cable Options on Technical Features page

Internal Circuit (Electronic): See Circuit Options on Circuits Available page

Environmental

Protection: IP65 (IP67 available upon request)
 Certifications: UL Listed, File E218123 (available upon request)

Drawing	Pitch	Poles	Cable Type	Max. Current per Contact	Max. Voltage	1.0m		2.0m		5.0m		10.0m		Type
						Engineering No.	Standard Order No.	Engineering No.	Standard Order No.	Engineering No.	Standard Order No.	Engineering No.	Standard Order No.	
	11.00mm	2	PVC H05 0.75mm ²	5.0A	250V AC 300V DC	E162N3N10021	121040-0295	E162N3N20021	121040-0305	E162N3N50021	121040-0320	E162N3N10K21	121040-0299	Non-Electronic
						For all Electronic part numbers, please use the Electronic Build-a-Part Number system in the Configuration Code below.								

Configuration Code*

Build-a-Part Number

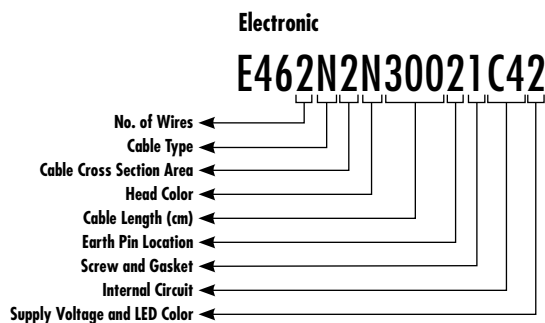
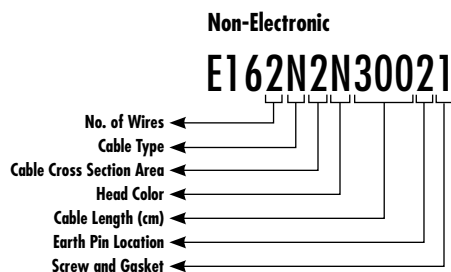

*Once an engineering number is created using the configuration code, consult Molex tech support for information regarding any part numbers.

Brad® mPm® Molded Cable DIN Valve Connectors Form B Non-Electronic, Electronic



Features and Benefits

- DIN overmolded connector according to UNI EN 175301-803
- Available in Form A, Form B, Form C, Industrial and Micro
- Fully overmolded provides IP65 as standard but available with IP67
- Protection for harsh environments
- Available in array of configurations:
 - Large variety of cable types
 - H12 ground position standard (more orientations available upon request)
 - Black head standard (gray available upon request)
 - UL listed versions available
 - Large variety of integrated electronic circuit versions available
 - Different gasket available (flat, profile)

Physical

Pitch: 10.00mm
 Overmolding Material: Polypropylene
 Gasket: NBR black (silicon gasket available upon request)
 Contacts: Brass with Silver plating
 Wire: PVC (more available upon request)
 No. of Wires: 1—2 Wires
 2—2 Wires plus Earth
 Head Color: G—Gray
 N—Black
 A—Black (UL)
 B—Gray (UL)
 Cable Length (cm): 050—0.5m
 300—3.0m
 10K—10.0m
 Earth Pin Location: 6—H6
 2—H12

Gasket Screws:

- 1—NBR Profile Gasket Plus Fixing Screw
- 2—NBR Flat Gasket Plus Fixing Screw
- 3—Silicon Profile Gasket Plus Fixing Screw
- 4—Silicon Flat Gasket Plus Fixing Screw

Physical (continued)

Voltage, LED Color (Electronic):
 Red LED: 1—12V
 2—24
 3—48V
 4—115V
 5—230V
 Green LED: A—12V
 B—24V
 C—48V
 D—115V
 E—230V
 Amber LED: G—12V
 H—24V
 K—48V
 L—115V
 M—230V

Cable Cross Section Area: See Cable Options on Technical Features page

Cable Type: See Cable Options on Technical Features page
 Internal Circuit (Electronic): See Circuit Options on Circuits Available page

Environmental

Protection: IP65 (IP67 available upon request)
 Certifications: UL Listed, File E218123 (available upon request)

Configuration Code*

Build-a-Part Number

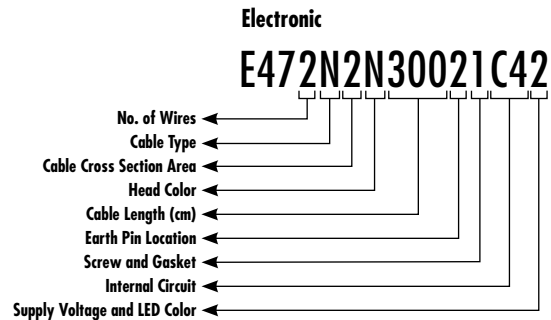
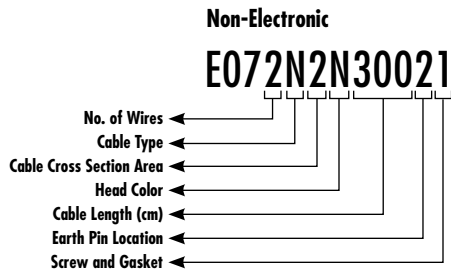
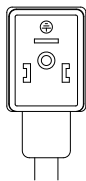

*Once an engineering number is created using the configuration code, consult Molex tech support for information regarding any part numbers.

Brad® mPm® Molded Cable DIN Valve Connectors

121040

Form C
Non-Electronic, Electronic



Features and Benefits

- DIN overmolded connector according to UNI EN 175301-803
- Available in Form A, Form B, Form C, Industrial and Micro
- Fully overmolded provides IP65 as standard but available with IP67
- Protection for harsh environments
- Available in array of configurations:
 - Large variety of cable types
 - H12 ground position standard (more orientations available upon request)
 - Black head standard (gray available upon request)
 - UL listed versions available
 - Large variety of integrated electronic circuit versions available
 - Different gasket available (flat, profile)

Physical

Overmolding Material: Polypropylene
 Gasket: NBR black (silicon gasket available upon request)
 Contacts: Brass with Silver plating
 Wire: PVC (more available upon request)
 No. of Wires: 1—2 Wires
 2—2 Wires plus Earth
 3—4 Wires
 5—2 Wires (SMC Compatible)
 6—3 Wires (SMC Compatible)
 7—4 Wires (SMC Compatible)

Head Color: G—Gray
 N—Black
 A—Black (UL)
 B—Gray (UL)

Cable Length (cm): 050—.050cm
 300—3.0m
 10K—10.0m

Earth Pin Location: 1—H6/12 Double Earth
 6—H6
 2—H12

Gasket Screws:

- 1—NBR Profile Gasket Plus Fixing Screw
- 2—NBR Flat Gasket Plus Fixing Screw
- 3—Silicon Profile Gasket Plus Fixing Screw
- 4—Silicon Flat Gasket Plus Fixing Screw

Physical (continued)

Voltage, LED Color (Electronic):

Red LED: 1—12V
 2—24V
 3—48V
 4—115V
 5—230V
 Green LED: A—12V
 B—24V
 C—48V
 D—115V
 E—230V
 Amber LED: G—12V
 H—24V
 K—48V
 L—115V
 M—230V

Cable Cross Section Area: See Cable Options on Technical Features page

Cable Type: See Cable Options on Technical Features page

Internal Circuit (Electronic): See Circuit Options on Circuits Available page

Environmental

Protection: IP65 (IP67 available upon request)
 Certifications: UL Listed, File E218123 (available upon request)

Drawing	Pitch	Poles	Cable Type	Max. Current per Contact	Max. Voltage	1.0m		2.0m		5.0m		10.0m		Type
						Engineering No.	Standard Order No.	Engineering No.	Standard Order No.	Engineering No.	Standard Order No.	Engineering No.	Standard Order No.	
	8.00mm	2	PVC H03 0.50mm ²	3.0A	250V AC 300V DC	E432N2N10011	121040-0491	E432N2N20011	121040-0496	E432N2N50011	121040-0500	E432N2N10K11	121040-0493	Non-Electronic
		3	PVC H03 0.50mm ²	3.0A	250V AC 300V DC	E433N2N10021	121040-1258	E433N2N20021	121040-1259	E433N2N50021	121040-0511	E433N2N10K21	121040-1109	
For all Electronic part numbers, please use the Electronic Build-a-Part Number system in the Configuration Code below.														Electronic

Configuration Code*

Build-a-Part Number

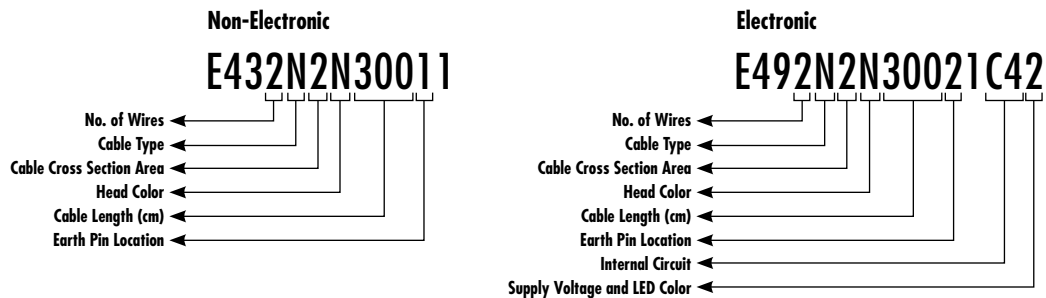

*Once an engineering number is created using the configuration code, consult Molex tech support for information regarding any part numbers.

Brad® mPm® Molded Cable DIN Valve Connectors

121040

Form Micro
Non-Electronic, Electronic



Features and Benefits

- DIN overmolded connector according to UNI EN 175301-803
- Available in Form A, Form B, Form C, Industrial and Micro
- Fully overmolded provides IP65 as standard but available with IP67
- Protection for harsh environments
- Available in array of configurations:
 - Large variety of cable types
 - H12 ground position standard (more orientations available upon request)
 - Black head standard (gray available upon request)
 - UL listed versions available
 - Large variety of integrated electronic circuit versions available
 - Different gasket available (flat, profile)

Physical

Overmolding Material: Polypropylene
 Gasket: NBR black (silicon gasket available upon request)
 Contacts: Brass with Silver plating
 Wire: PVC (more available upon request)
 No. of Wires: 1—Need description
 2—Need description
 3—4 Wires
 5—2 Wires (SMC Compatible)
 6—3 Wires (SMC Compatible)
 7—4 Wires (SMC Compatible)
 Head Color: G—Gray
 N—Black
 A—Black (UL)
 B—Gray (UL)
 Cable Length (cm): 050—050cm
 300—3.0m
 10K—10.0m
 Earth Pin Location: 1—H6/12 Double Earth
 6—H6
 2—H12
 Gasket Screws:
 1—NBR Profile Gasket Plus Fixing Screw
 2—NBR Flat Gasket Plus Fixing Screw
 3—Silicon Profile Gasket Plus Fixing Screw
 4—Silicon Flat Gasket Plus Fixing Screw

Physical (continued)

Voltage, LED Color (Electronic):
 Red LED: 1—12V
 2—24V
 3—48V
 4—115V
 5—230V
 Green LED: A—12V
 B—24V
 C—48V
 D—115V
 E—230V
 Amber LED: G—12V
 H—24V
 K—48V
 L—115V
 M—230V
 Cable Cross Section Area: See Cable Options on Technical Features page
 Cable Type: See Cable Options on Technical Features page
 Internal Circuit (Electronic): See Circuit Options on Circuits Available page

Environmental

Protection: IP65 (IP67 available upon request)
 Certifications: UL Listed, File E218123 (available upon request)

Drawing	Pitch	Poles	Cable Type	Max. Current per Contact	Max. Voltage	1.0m		2.0m		5.0m		10.0m		Type
						Engineering No.	Standard Order No.	Engineering No.	Standard Order No.	Engineering No.	Standard Order No.	Engineering No.	Standard Order No.	
	9.40mm	2	PVC H03 0.50mm ²	3.0A	250V AC 300V DC	E332N2N10011	121040-0422	E332N2N20011	121040-0436	E332N2N50011	121040-0451	E332N2N10K11	121040-0428	Non-Electronic
		3	PVC H03 0.50mm ²	3.0A	250V AC 300V DC	E333N2N10021	121040-1260	E333N2N20021	121040-0470	E333N2N50021	121040-0887	E333N2N10K21	121040-0703	
For all Electronic part numbers, please use the Electronic Build-a-Part Number system in the Configuration Code below.														Electronic

Configuration Code* Build-a-Part Number

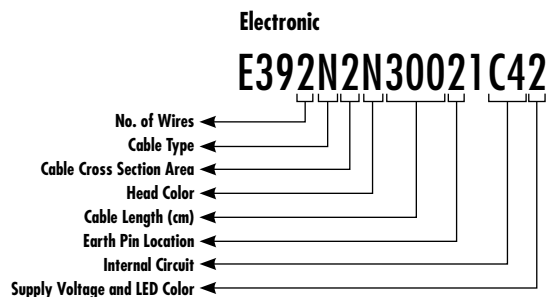
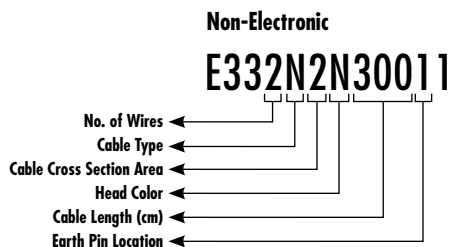

*Once an engineering number is created using the configuration code, consult Molex tech support for information regarding any part numbers.

mPm[®] Technical Features

Cable Types

Cable Type	Code	Features	Stranding	Bending Radius
PVC	N	Application general purpose cable which has good resistance to water, but usually poor oil resistance.	0.5mm ² = 15 x 0.20 0.75mm ² = 21 x 0.20 1mm ² = 28 x 0.20	15X outside diameter
CEI	I	Approved to IEC 332-2A, flame retardant and self extinguishing. Limited resistance to mineral oils.	0.5mm ² = 28 x 0.15 0.75mm ² = 42 x 0.15 1mm ² = 32 x 0.20	10X outside diameter
PUR	P	Offers good resistance to oil and chemicals. Can swell when constantly immersed in water.	0.5mm ² = 28 x 0.15 0.75mm ² = 42 x 0.15 1mm ² = 32 x 0.20	10X outside diameter
PVC CSA-UL	A	Approved to CSA-UL 2661, application general purpose cable which has good resistance to water, but usually poor oil resistance.	20 AWG = 32 x 0.15 18 AWG = 52 x 0.15	10X outside diameter
PUR CSA-UL	B	Approved to CSA-UL 20668. Very good resistance to oil and chemicals.	20 AWG = 32 x 0.15 18 AWG = 52 x 0.15	10X outside diameter

Technical Features

mPm Code	Material	Color	Conductors	Section	External Diameter	Temperature Range	DIN A-B	DIN C	
I	2	PVC CEI 2022 II O.R.	Gray RAL7035	2	0.5mm ²	5.5±0.2mm	-5 to +70	x	x
I	2	PVC CEI 2022 II O.R.	Gray RAL7035	3	0.5mm ²	5.5±0.2mm	-5 to +70	x	x
I	2	PVC CEI 2022 II O.R.	Gray RAL7035	4	0.5mm ²	6.5±0.2mm	-5 to +70	x	
I	2	PVC CEI 2022 II O.R.	Gray RAL7035	5	0.5mm ²	7±0.2mm	-5 to +70	x	
P	2	PUR - BLEND	Black	2	0.5mm ²	5.5±0.2mm	-5 to +70	x	x
P	2	PUR - BLEND	Black	3	0.5mm ²	5.5±0.2mm	-5 to +70	x	x
P	2	PUR - BLEND	Black	5	0.5mm ²	7±0.2mm	-5 to +70	x	x
A	2	PVC CSA/UL 2661	Black	2	20 AWG	5.5±0.2mm	-15 to +105	x	x
A	2	PVC CSA/UL 2661	Black	3	20 AWG	5.6±0.2mm	-15 to +105	x	x
A	2	PVC CSA/UL 2661	Black	4	20 AWG	6.2±0.2mm	-15 to +105	x	x
A	2	PVC CSA/UL 2661	Black	5	20 AWG	7±0.2mm	-15 to +105	x	
B	2	PUR CSA/UL 20668	Black	2	20 AWG	5.5±0.2mm	-25 to +90	x	x
B	2	PUR CSA/UL 20668	Black	3	20 AWG	5.6±0.2mm	-25 to +90	x	x
B	2	PUR CSA/UL 20668	Black	4	20 AWG	6.2±0.2mm	-25 to +90	x	x
B	2	PUR CSA/UL 20668	Black	5	20 AWG	7±0.2mm	-25 to +90	x	
P	3	PUR - BLEND	Black	2	0.75mm ²	6.5±0.2mm	-5 to +70	x	
P	3	PUR - BLEND	Black	3	0.75mm ²	6.5±0.2mm	-5 to +70	x	
P	3	PUR - BLEND	Black	4	0.75mm ²	7±0.2mm	-5 to +70	x	
A	3	PVC CSA/UL 2661	Black	2	18 AWG	6.5±0.2mm	-15 to +105	x	
A	3	PVC CSA/UL 2661	Black	3	18 AWG	6.5±0.2mm	-15 to +105	x	
A	3	PVC CSA/UL 2661	Black	4	18 AWG	7±0.2mm	-15 to +105	x	
A	3	PVC CSA/UL 2661	Black	5	18 AWG	7.8±0.2mm	-15 to +105	x	
B	3	PUR CSA/UL 20668	Black	2	18 AWG	6.5±0.2mm	-25 to +90	x	
B	3	PUR CSA/UL 20668	Black	3	18 AWG	6.5±0.2mm	-25 to +90	x	
B	3	PUR CSA/UL 20668	Black	4	18 AWG	7±0.2mm	-25 to +90	x	
B	3	PUR CSA/UL 20668	Black	5	18 AWG	7.8±0.2mm	-25 to +90	x	
I	4	PVC CEI 2022 II O.R.	Gray RAL7035	2	1mm ²	7.1+0.2-0mm	-5 to +70	x	
I	4	PVC CEI 2022 II O.R.	Gray RAL7035	3	1mm ²	7.1+0.2-0mm	-5 to +70	x	
N	2	PVCH03	Black	2	0.5mm ²	5.1+ 0.2-0mm	-5 to +70	x	x
N	2	PVCH03	Black	3	0.5mm ²	5.4+ 0.2-0mm	-5 to +70	x	x
N	2	PVCH03	Black	4	0.5mm ²	5.75+0.2-0mm	-5 to +70	x	x
N	3	PVCH05	Black	2	0.75mm ²	6.2+ 0.2-0mm	-5 to +70	x	
N	3	PVCH05	Black	3	0.75mm ²	6.6+0.2-0mm	-5 to +70	x	
N	3	PVCH05	Black	4	0.75mm ²	7.15+0.2-0mm	-5 to +70	x	
N	3	PVCH05	Black	5	0.75mm ²	8.0+0.2-0mm	-5 to +70	x	
N	4	PVCH05	Black	+2	1mm ²	6.5+0.2-0mm	-5 to +70	x	
N	4	PVCH05	Black	3	1mm ²	6.9+0.2-0mm	-5 to +70	x	

mPm[®] Available Circuits

Input	Circuit Schematic	Circuit Description	Product Form	
			Overmoulded	Field Attachable
V AC-DC		<p>Circuit A0 With filament lamp for 12 or 24V or with neon lamp for 115 or 230V</p>		S 222 S 282 S 922
V AC-DC		<p>Circuit A1 With bipolar LED Bipolar LED voltage: 12 to 230V</p>	E 452 E 482 E 472 E 392 E 492	S 222 S 282 S 922 S 252 S 292
V DC		<p>Circuit C3 With LED plus blocking diode to protect against overvoltage when switching off. Voltage 12 to 230V.</p>	E 452 E 462 E 472 E 392 E 492	S 222 S 282 S 922 S 252 S 292
V AC-DC		<p>Circuit C4 Bipolar LED and VDR to protect supply and switch. (The energy in the coil is limited by the VDR). Voltage: 12 to 230V.</p>	E 452 E 462 E 472 E 392 E 492	S 222 S 282 S 922 S 252 S 292
V AC-DC		<p>Circuit D0 With VDR to protect supply and switch from overvoltage. (The energy in the coil is limited by the VDR).</p>	E 452 E 462 E 472 E 392 E 492	S 222 S 282 S 922 S 252 S 292
V DC		<p>Circuit E0 With blocking diode to protect against overvoltage when switching off.</p>	E 452 E 462 E 472 E 392 E 492	S 222 S 282 S 922 S 252 S 292
V AC-DC		<p>Circuits S0 With transient suppressor (Transil) to provide blocking of input and output overvoltage, plus LED indicator to confirm voltage presence.</p>	E 452 E 462 E 472	S 222 S 282 S 922
V AC-DC		<p>Circuits S1 With transient suppressor (Transil) to provide blocking of input and output overvoltage.</p>		S 222 S 282 S 922

Power Products

NFPA 79-2012 Compliant	204
Trunk/Feeder	
Cordsets	205 to 207
Tees	208
Reducers	209
Receptacles	210
Field Attachable Connectors	211
Drop/Branch	
Cordsets	212 to 214
Receptacles	215
Field Attachable Connectors	216
Accessories	
Closure Caps and Locking Clips	217
Emergency Stop Cordsets and Tees	218
Emergency Stop Receptacles and Terminators	219

Power Ultra products

Pipe and wire is how we used to distribute power to machine outputs. Today, more design engineers are choosing Brad® Power modular, flexible power wiring systems from Molex. Beginning with machine assembly, Brad® power solutions save money and time.

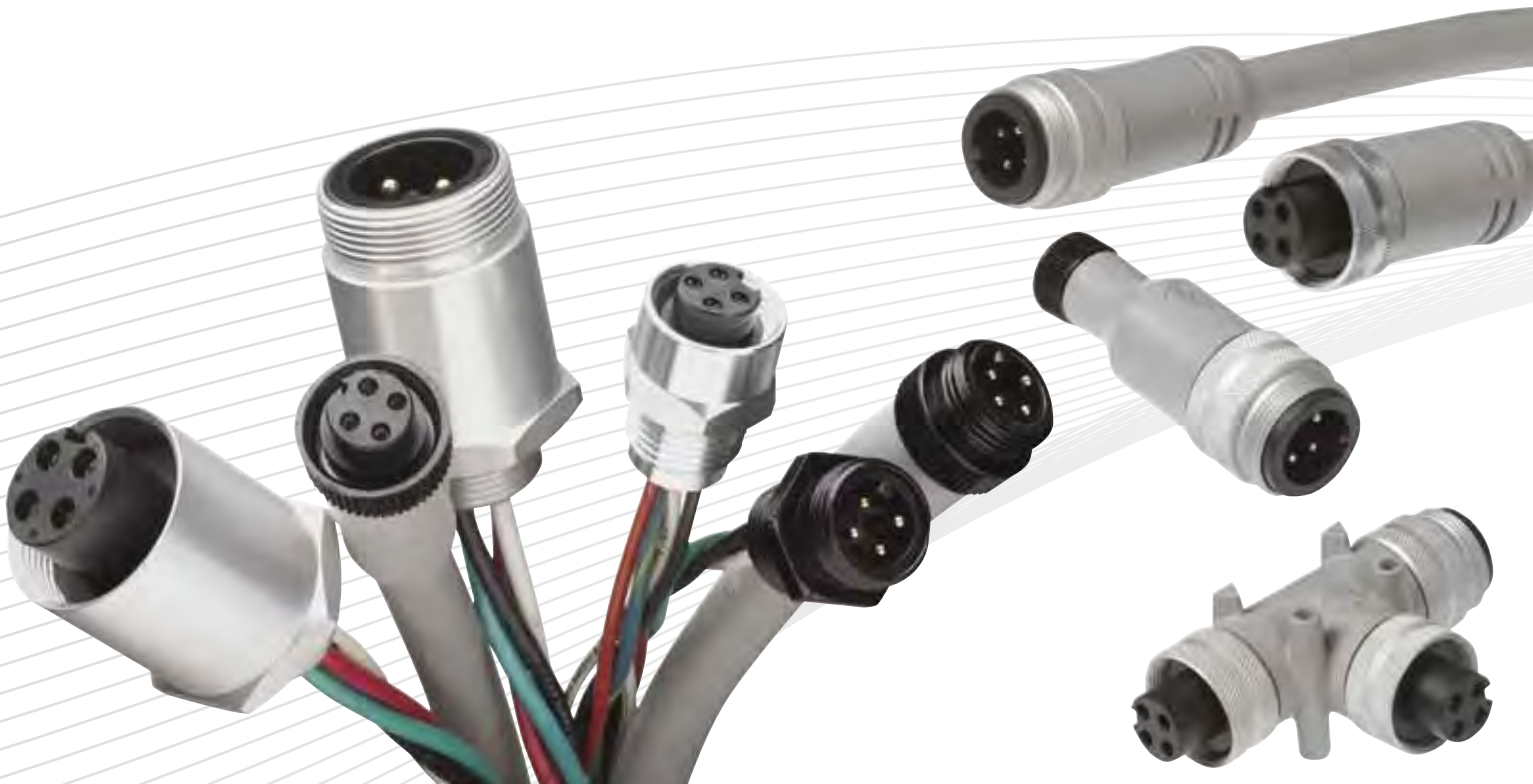

Modular power for everyone

Brad® Power modular components make installation faster, easier and more reliable. Where multiple machines are involved, assembling the systems is consistent and repeatable.

Compared to traditional hard wiring, Brad® Power solutions provide reduced labor costs, simplified connections, increased plant flexibility and reduced commission time. They also deliver rapid return on capital equipment investments.

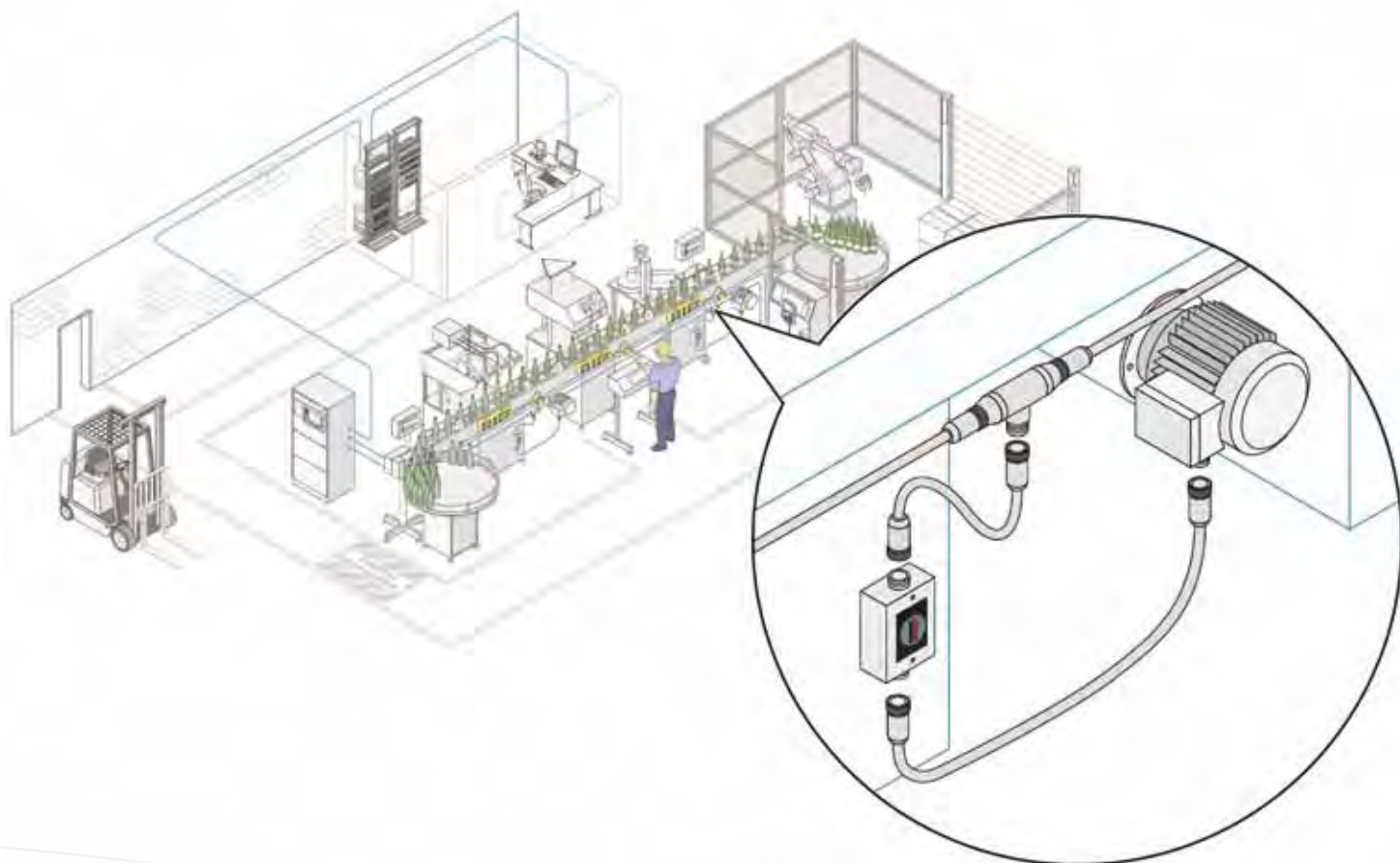

Cut your total installed cost

Brad® quick-connect, modular wiring solutions install easily and make commissioning simple. In fact, electrical installation and commissioning times can be slashed by as much as 80%. And that can translate into a total installed cost (TIC) reduction of 20% to 50% vs. conventional hard-wiring thanks to:

- No specialized tools
- No pipe bending
- No wire pulling
- No conduit or raceways required
- Reduced labor time
- Minimized testing and troubleshooting

Reduce your total cost of ownership

The Brad® Power system delivers a higher return on investment (ROI) because the total cost of ownership (TCO) continues to drop the longer the system is owned, used and maintained. Benefits include:

- Increased machine uptime
- Faster, easier maintenance of failed machine devices
- Simplified scalability
- Parts that can be reused over and over

NFPA 79-2012 Compliant

It took a 2002 electrical code revision (and further refinements in 2007 and 2012) to enable system designers and users to experience this practical alternative to hard-wired power distribution and motor control on industrial equipment and machine tools. Compare the codes:

	1997 Edition	2012 Edition
Conductor Sizing for Power Circuits	Section 15.3 (a): Conductors shall not be smaller than 14 AWG.	Section 12.6.1 Conductors shall not be smaller than 14 AWG for power circuits unless otherwise permitted in 12.6.1.1 (16 AWG) and 12.6.1.2 (18 AWG).
Wiring Methods and Practices Regarding Connectors	Section 16.1.4: Conductors and cables shall be run without splices from terminal to terminal.	Section 13.1.2.3 Factory-applied connectors, molded onto cables, shall be permitted. Such connectors shall not be considered as splices or joints.
Wiring Methods and Practices Regarding Exposed Cable	Section 16.3.1: Conductors and their connections, external to the control panel, shall be totally enclosed in suitable raceways or enclosures.	Section 13.1.6.1 Exposed cables, installed along the structure of the equipment or system or in the chases of the machinery, shall be permitted. Exposed cables shall be installed to closely follow the surface and structural members of the machinery.

UL 2237 (PVVA) Listed

Brad® Power products are designed to interconnect high-energy devices, such as motors, heaters, and pumps to their power source. In such applications, there is a high potential for extreme electrical transients to occur during a fault condition before the over-current protection device (i.e. fuse or breaker) trips. Brad Power

products have been tested and proven to withstand these fault conditions under UL 2237.

UL 2237 covers interconnect systems intended for use in power branch circuits, including motor branch circuits in industrial machinery.

The UL 2237 Listing assures that our wiring system integrity and safety is preserved, even after a fault has occurred in the installation. Just reset, or eliminate the fault condition, and continue operating.

Applications

Power distribution and motor control in:

- Complex automated assembly equipment
- Material handling and conveying equipment
- Food/beverage processing and packaging
- Pharmaceutical process equipment
- Petrochemical plants

Design and Quality

- UL 2237 (PVVA) approved
- Rugged, factory-applied connectors over-molded
- Strong, crush-resistant TC-ER cable
- Convenient, field attachable connectors

A Complete System

There are no holes in the Brad Power solution. It's all here, including: receptacles, trunk/feeder cordsets and connectors, drop/branch cordsets and connectors, tees, reducers, and accessories (locking clips, closure caps, field attachable connectors, etc.). Stainless steel hardware is available as an option.

Machine builders will appreciate the increased worker productivity, reduced manufacturing costs, quicker time to market and improved profit margins. System designers, integrators and plant engineers will enjoy the faster commissioning times,

lower installation costs and simplified maintenance and repair. And everyone will appreciate the fact that Brad Power solutions are from Molex, a leading single-source supplier of interconnect products. Backed by a firm commitment to research and development, the Molex team of skilled experts is passionate about designing, developing and distributing innovative connection solutions for you.

Brad® Power Trunk/Feeder Single-Ended Cordsets

130063

**Female
Straight, Right Angle
Threaded**



Features and Benefits

- Meets NFPA 79-2012 standards for motor and branch circuits
- UL 2237 (PVVA) listed

Reference Information

UL File No.: E258922

Electrical

Voltage: 600V AC/DC

Mechanical

Wire Size: 10 AWG

Physical

Connector Face: PVC

Connector Body: PVC

Cable: A48—UL Type STOOW/TC-ER

Cable Jacket: PVC

Cable Jacket Color: Gray

Contact: Copper alloy with Gold over Nickel plating

Coupling Nut: Anodized Aluminum

Operating Temperature: -20 to +105° C

Environmental

Protection: IP67, IP68 and IP69K (with Stainless Steel)

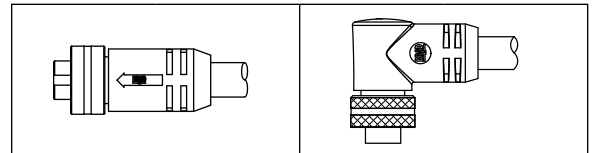

Poles (Female View)	Current	Keyway	Cable Jacket (Cable Code)	Wire Size AWG	Length	Female Straight		Female Right Angle	
						Engineering No.	Standard Order No.	Engineering No.	Standard Order No.
3 Pole 1 - Black 3 - White 2 - Green/Yellow-gnd	32.0A	Single	PVC (A48)	10	2.0m	C03000A48M020	130063-0003	C03001A48M020	130063-0037
3 Pole 1 - Black 3 - White 2 - Green/Yellow-gnd		Alternate				C03100A48M020	130063-0056	C03101A48M020	130063-0199
4 Pole 1 - Black 2 - Green/Yellow-gnd 3 - Red 4 - White	32.0A	Single	PVC (A48)	10	2.0m	C04000A48M020	130063-0089	C04001A48M020	130063-0135
4 Pole 1 - Black 2 - Green/Yellow-gnd 3 - Red 4 - White		Alternate				C04100A48M020	130063-0181	C04101A48M020	130063-0183

Note: Sales drawings for all standard order numbers are available on molex.com

Configuration Code*
Build-a-Part Number

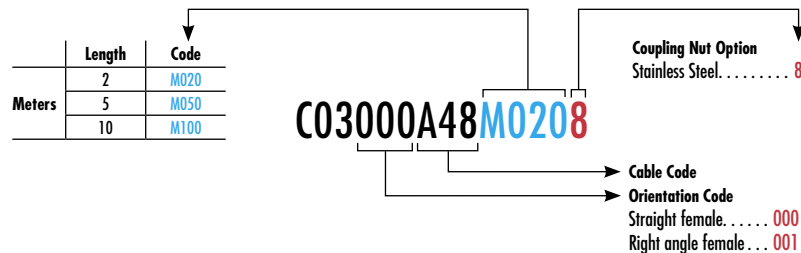

*Once an engineering number is created using the configuration code, consult Molex tech support for information regarding any part numbers.

Brad® Power Trunk/Feeder Single-Ended Cordsets

130063

**Male
Straight, Right Angle
Threaded**



Features and Benefits

- Meets NFPA 79-2012 standards for motor and branch circuits
- UL 2237 (PVVA) listed

Reference Information

UL File No.: E258922

Electrical

Voltage: 600V AC/DC

Mechanical

Wire Size: 10 AWG

Physical

Connector Face: PVC

Connector Body: PVC

Cable: A48—UL Type STOOW/TC-ER

Cable Jacket: PVC

Cable Jacket Color: Gray

Contact: Copper alloy with Gold over Nickel plating

Coupling Nut: Anodized Aluminum

Operating Temperature: -20 to +105° C

Environmental

Protection: IP67, IP68 and IP69K (with Stainless Steel)

Poles	Current	Keyway	Cable Jacket (Cable Code)	Wire Size AWG	Length	Male Straight		Male Right Angle	
						Engineering No.	Standard Order No.	Engineering No.	Standard Order No.
3 Pole 1 - Black 3 - White 2 - Green/Yellow-gnd	32.0A	Single	PVC (A48)	10	2.0m	C03006A48M020	130063-0042	C03007A48M020	130063-0194
		Alternate				C03106A48M020	130063-0200	C03107A48M020	130063-0201
4 Pole 1 - Black 3 - Red 2 - Green/Yellow-gnd 4 - White	32.0A	Single	PVC (A48)	10	2.0m	C04006A48M020	130063-0150	C04007A48M020	130063-0169
		Alternate				C04106A48M020	130063-0012	C04107A48M020	130063-0189

Note: Sales drawings for all standard order numbers are available on molex.com

Configuration Code*

Build-a-Part Number

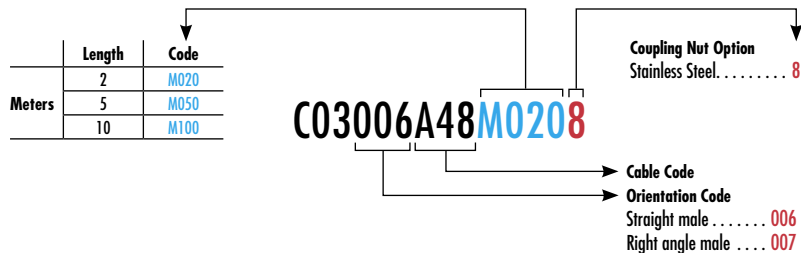

*Once an engineering number is created using the configuration code, consult Molex tech support for information regarding any part numbers.

Brad® Power Trunk/Feeder Double-Ended Cordsets

130064

Female Straight-to-Male Straight Threaded



Features and Benefits

- Meets NFPA 79-2012 standards for motor and branch circuits
- UL 2237 (PVVA) listed

Reference Information

UL File No.: E258922

Electrical

Voltage: 600V AC/DC

Mechanical

Wire Size: 10 AWG

Physical

Connector Face: PVC

Connector Body: PVC

Contact: Copper alloy with Gold over Nickel plating

Cable: A48—UL Type STOOW/TC-ER

Cable Jacket: PVC

Cable Jacket Color: Gray

Coupling Nut: Anodized Aluminum

Operating Temperature: -20 to +105° C

Environmental

Protection: IP67, IP68, IP69K (with Stainless Steel)

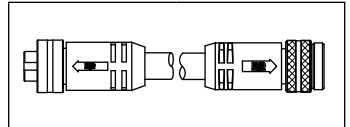

Poles (Female View)	Current	Keyway	Cable Jacket (Cable Code)	Wire Size AWG	Length	Female Straight-to-Male Straight	
						Engineering No.	Standard Order No.
3 Pole 	32.0A	Single	PVC (A48)	10	2.0m	CC3030A48M020	130064-0065
3 Pole 		Alternate				CC3130A48M020	130064-0401
4 Pole 	32.0A	Single	PVC (A48)	10	2.0m	CC4030A48M020	130064-0187
4 Pole 		Alternate				CC4130A48M020	130064-0356

Note: Sales drawings for all standard order numbers are available on molex.com

Configuration Code*
Build-a-Part Number

	Length	Code
Meters	2	M020
	5	M050
	10	M100

CC3030A48M0208

Coupling Nut Option
Stainless Steel..... **8**

Cable Code

Orientation Code

Straight female-to-straight male **030**

Right angle female-to-straight male **031**

Straight female-to-right angle male **032**

Right angle female-to-right angle male **033**

*Once an engineering number is created using the configuration code, consult Molex tech support for information regarding any part numbers.

Brad® Power Trunk Tees

130068

Trunk-to-Trunk and Trunk-to-Drop



Features and Benefits

- Meets NFPA 79-2012 standards for motor and branch circuits
- UL 2237 (PVVA) listed

Reference Information

UL File No.: E258922

Electrical

Voltage: 600V AC/DC

Physical

Connector Face: PVC

Connector Body: PVC

Contact: Copper alloy with Gold over Nickel plating

Coupling Type: Anodized Aluminum/epoxy-coated Zinc

Cable Type: UL Type STOOW, TC-ER



Cable Jacket: PVC



Cable Jacket Color: Gray

Operating Temperature: -20 to +105° C

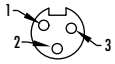
Environmental

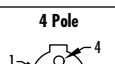
Protection: IP67, IP68, IP69K (with Stainless Steel)

Poles (Female View)	Current	Keyway	Trunk-to-Trunk	
			Engineering No.	Standard Order No.
 <p>3 Pole</p>	32.0A	Single	TC30C30-200	130068-0045
 <p>3 Pole</p>		Alternate	TC31C31-200	130068-0055
 <p>4 Pole</p>	32.0A	Single	TC40C40-200	130068-0079
 <p>4 Pole</p>		Alternate	TC41C41-200	130068-0086

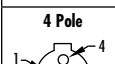
Poles (Female View)	Current	Keyway	Trunk-to-Drop	
			Engineering No.	Standard Order No.
 <p>3 Pole</p>	32.0A Trunk / 15.0A Drop	Single	TC30130-200	130068-0034
 <p>3 Pole</p>		Alternate	TC31130-200	130068-0051
 <p>4 Pole</p>	32.0A Trunk / 13.0A Drop	Single	TC40140-200	130068-0069
 <p>4 Pole</p>		Alternate	TC41140-200	130068-0082

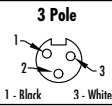
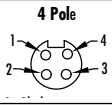
Poles (Female View)	Current	Keyway	Cable AWG	Trunk-to-Drop	
				Engineering No.	Standard Order No.
 <p>3 Pole</p> <p>1 - Black 3 - White</p>	32.0A Trunk / 15.0A Drop	Single	14	TC30200A46M010	130068-0042
	32.0A Trunk / 13.0A Drop		16	TC30200A45M010	130068-0039
 <p>4 Pole</p>	32.0A Trunk / 15.0A Drop	Single	14	TC40200A46M010	130068-0075
	32.0A Trunk / 10.0A Drop		16	TC40200A45M010	130068-0072

Note: Sales drawings for all standard order numbers are available on molex.com

Configuration Code*
Build-a-Part Number

	Length	Code
Meters	2	M020
	5	M050
	10	M100

TC30200A46M0108

Coupling Nut Option
Stainless Steel..... 8

→ Cable Code

*Once an engineering number is created using the configuration code, consult Molex tech support for information regarding any part numbers.

Brad® Power Truck-to-Drop Reducers

130068
Male-Female
Straight
Threaded



Features and Benefits

- Meets NFPA 79-2012 standards for motor and branch circuits
- UL 2237 (PVVA) listed

Reference Information

UL File No.: E258922

Electrical

Voltage: 600V AC/DC

Physical

Connector Face: PVC

Connector Body: PVC

Contact: Copper alloy with Gold over Nickel plating

Coupling Nut: Anodized Aluminum/epoxy-coated Zinc

Operating Temperature: -20 to +90° C

Environmental

Protection: IP67, IP68, IP69K (with Stainless Steel)

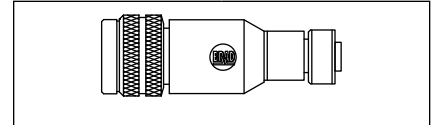

Poles (Male View)	Current	Keyway	Engineering No.	Standard Order No.
3 Pole 	15.0A	Single	1C3030-001	130068-0015
3 Pole 		Alternate	1C3130-001	130068-0017
4 Pole 	15.0A	Single	1C4030-001	130068-0019
4 Pole 		Alternate	1C4130-001	130068-0022

Note: Sales drawings for all standard order numbers are available on molex.com

Configuration Code*
Build-a-Part Number

1C3030-0018

Coupling Nut Option
Stainless Steel. **8**

*Once an engineering number is created using the configuration code, consult Molex tech support for information regarding any part numbers.

Brad® Power Trunk/Feeder Receptacles

130066
Female, Male
Straight



Features and Benefits

- Meets NFPA 79-2012 standards for motor and branch circuits
- UL 2237 (PVVA) listed

Reference Information

UL File No.: E258922

Electrical

Voltage: 600V AC/DC

Mechanical

Wire Size: 10 AWG

Wire Type: UL Type THHN

Physical

Connector Face: PVC

Shell: Anodized Aluminum

Contact: Copper alloy with Gold over Nickel plating

Panel Mount: Front

Environmental

Protection: IP67, IP68 (IP69K with Stainless Steel)

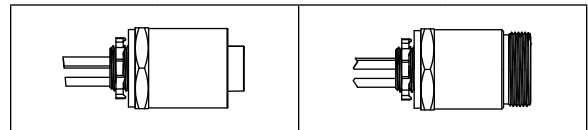

Poles (Female View)	Current	Keyway	Mounting Thread Size	Female		Male	
				Engineering No.	Standard Order No.	Engineering No.	Standard Order No.
3 Pole 1 - Black 3 - White 2 - Green/Yellow-gnd	32.0A	Single	1/2" - 14 NPT	CR3000A30M005	130066-0110	CR3006A30M005	130066-0255
			3/4" - 14 NPT	CR3C00A30M005	130066-0134	CR3C06A30M005	130066-0143
3 Pole 1 - Black 3 - White 2 - Green/Yellow-gnd	32.0A	Alternate	1/2" - 14 NPT	CR3100A30M005	130066-0256	CR3106A30M005	130066-0257
			3/4" - 14 NPT	CR3D00A30M005	130066-0258	CR3D06A30M005	130066-0259
4 Pole 1 - Black 4 - White 2 - Green/Yellow-gnd 3 - Red	32.0A	Single	1/2" - 14 NPT	CR4000A30M005	130066-0152	CR4006A30M005	130066-0170
			3/4" - 14 NPT	CR4C00A30M005	130066-0189	CR4C06A30M005	130066-0203
4 Pole 1 - Black 4 - White 2 - Green/Yellow-gnd 3 - Red	32.0A	Alternate	1/2" - 14 NPT	CR4100A30M005	130066-0260	CR4106A30M005	130066-0186
			3/4" - 14 NPT	CR4D00A30M005	130066-0261	CR4D06A30M005	130066-0262

Note: Sales drawings for all standard order numbers are available on molex.com

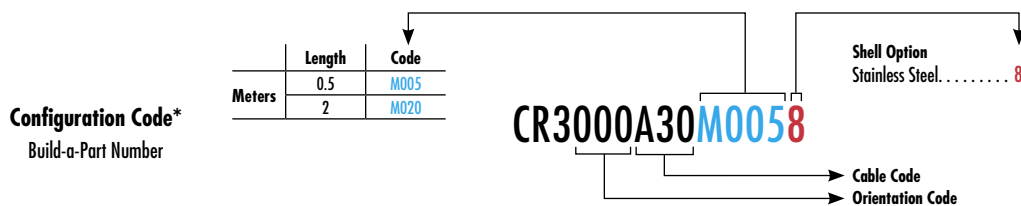

*Once an engineering number is created using the configuration code, consult Molex tech support for information regarding any part numbers.

Brad® Power Trunk/Feeder Field Attachable Connectors

130070

**Internal Thread Female
External Thread Male**



Features and Benefits

- Special contact design for reliability and low resistance
- Allows easy field conversion to quick-connect or repair of damaged, molded connectors

Reference Information

UL File No.: E258922

Electrical

Voltage: 600V AC/DC

Mechanical

Wire Size: 14 to 8 AWG

Cable Range: .43 to .82" (11 to 21mm)

Physical

Connector Face: PVC

Connector Body: Nylon

Contact: Copper alloy with Gold over Nickel plating

Coupling Nut: Anodized Aluminum



Grommet: Neoprene

Operating Temperature: -20 to +80° C

Environmental

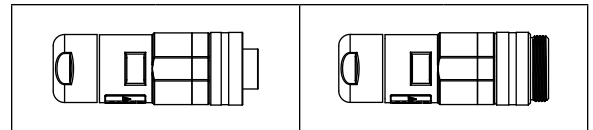
Protection: IP67, IP68, IP69K



Poles (Female View)	Current	Coupling Type	Female Straight		Male Straight	
			Engineering No.	Standard Order No.	Engineering No.	Standard Order No.
3 Pole 	32.0A	Internal Thread	CA3000-39	130070-0021		
		External Thread			CA3006-39	130070-0022
4 Pole 	32.0A	Internal Thread	CA4000-39	130070-0023		
		External Thread			CA4006-39	130070-0024

Brad® Power Drop/Branch Single-Ended Cordsets

130061

Female Straight, Right Angle Threaded



Features and Benefits

- Meets NFPA 79-2012 standard for motor and branch circuits
- UL 2237 (PVVA) listed

Reference Information

UL File No.: E258922

Electrical

Voltage: 600V AC/DC

Physical

Connector Face: PVC
 Connector Body: PVC
 Contact: Brass with Gold over Nickel plating
 Cable: A45—UL Type STOOW/TC-ER 16 AWG
 A46—UL Type STOOW/TC-ER 14 AWG
 Cable Jacket: PVC
 Cable Jacket Color: Gray
 Coupling Nut: Black epoxy-coated Zinc
 Operating Temperature: -20 to +105° C

Environmental

Protection: IP67, IP68 and IP69K (with Stainless Steel)

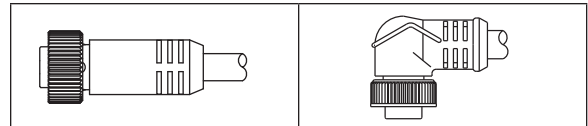

Poles	Current	Cable Type	Cable Jacket (Cable Code)	Wire Size AWG	Length	Female Straight		Female Right Angle	
						Engineering No.	Standard Order No.	Engineering No.	Standard Order No.
3 Pole 1 - Green/Yellow-gnd 2 - Black 3 - White	13.0A	STOOW/TC-ER	PVC (A45)	16	2.0m	103000A45M020	130061-0025	103001A45M020	130061-0220
	15.0A		PVC (A46)	14		103000A46M020	130061-0030	103001A46M020	130061-0040
4 Pole 1 - Black 2 - White 3 - Red 4 - Green/Yellow-gnd	10.0A	STOOW/TC-ER	PVC (A45)	16	2.0m	104000A45M020	130061-0080	104001A45M020	130061-0108
	15.0A		PVC (A46)	14		104000A46M020	130061-0091	104001A46M020	130061-0119

Note: Sales drawings for all standard order numbers are available on molex.com

Configuration Code*
Build-a-Part Number

	Length	Code
Meters	2	M020
	5	M050
	10	M100

103000A45M0208

Coupling Nut Option
Stainless Steel. 8

Cable Code
Orientation Code
Straight female. 000
Right angle female. 001

*Once an engineering number is created using the configuration code, consult Molex tech support for information regarding any part numbers.

Brad® Power Drop/Branch Single-Ended Cordsets

130061

Male Straight, Right Angle Threaded



Features and Benefits

- Meets NFPA 79-2012 standard for motor and branch circuits
- UL 2237 (PVVA) listed

Reference Information

UL File No.: E258922

Electrical

Voltage: 600V AC/DC

Physical

Connector Face: PVC
 Connector Body: PVC
 Contact: Brass with Gold over Nickel plating
 Cable: A45—UL Type ST00W/TC-ER 16 AWG
 A46—UL Type ST00W/TC-ER 14 AWG
 Cable Jacket: PVC
 Coupling Nut: Black epoxy-coated Zinc
 Cable Jacket Color: Gray
 Operating Temperature: -20 to +105° C

Environmental

Protection: IP67, IP68 and IP69K (with Stainless Steel)

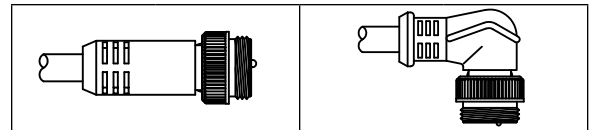

Poles	Current	Cable Type	Cable Jacket (Cable Code)	Wire Size AWG	Length	Male Straight		Male Right Angle	
						Engineering No.	Standard Order No.	Engineering No.	Standard Order No.
3 Pole 1 - Green/Yellow-gnd 2 - Black 3 - White	13.0A	ST00W/TC-ER	PVC (A45)	16	2.0m	103006A45M020	130061-0046	103007A45M020	130061-0218
	15.0A		PVC (A46)	14		103006A46M020	130061-0057	103007A46M020	130061-0073
4 Pole 1 - Black 2 - White 3 - Red 4 - Green/Yellow-gnd	10.0A	ST00W/TC-ER	PVC (A45)	16	2.0m	104006A45M020	130061-0135	104007A45M020	130061-0168
	15.0A		PVC (A46)	14		104006A46M020	130061-0150	104007A46M020	130061-0179

Note: Sales drawings for all standard order numbers are available on molex.com

Configuration Code*
Build-a-Part Number

	Length	Code
Meters	2	M020
	5	M050
	10	M100

103006A45M0208

Coupling Nut Option
Stainless Steel 8

Cable Code
Orientation Code
 Straight male 006
 Right angle male 007

*Once an engineering number is created using the configuration code, consult Molex tech support for information regarding any part numbers.

Brad® Power Drop/Branch Double-Ended Cordsets

130062 Threaded Female Straight-to-Male Straight



Features and Benefits

- Meets NFPA 79-2012 standard for motor and branch circuits
- UL 2237 (PVVA) listed

Reference Information

UL File No.: E258922

Electrical



Voltage: 600V AC/DC

Physical

Connector Face: PVC
 Connector Body: PVC
 Contact: Brass with Gold over Nickel plating
 Cable: A45—UL Type STOOW/TC-ER 16 AWG
 A46—UL Type STOOW/TC-ER 14 AWG
 Cable Jacket: PVC
 Cable Jacket Color: Gray
 Coupling Nut: Black epoxy-coated Zinc
 Operating Temperature: -20 to +105° C

Environmental

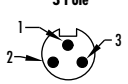
Protection: IP67, IP68 and IP69K (with Stainless Steel)

Poles (Male View)	Current	Cable Type	Cable Jacket (Cable Code)	Wire Size AWG	Length	Female Straight-to-Male Straight	
						Engineering No.	Standard Order No.
3 Pole  1 - Green/Yellow-gnd 2 - Black 3 - White	13.0A	STOOW/TC-ER	PVC (A45)	16	2.0m	113030A45M020	130062-0032
	15.0A		PVC (A46)	14		113030A46M020	130062-0047
4 Pole  1 - Black 2 - White 3 - Red 4 - Green/Yellow-gnd	10.0A	STOOW/TC-ER	PVC (A45)	16	2.0m	114030A45M020	130062-0088
	15.0A		PVC (A46)	14		114030A46M020	130062-0124

Note: Sales drawings for all standard order numbers are available on molex.com

Configuration Code* Build-a-Part Number

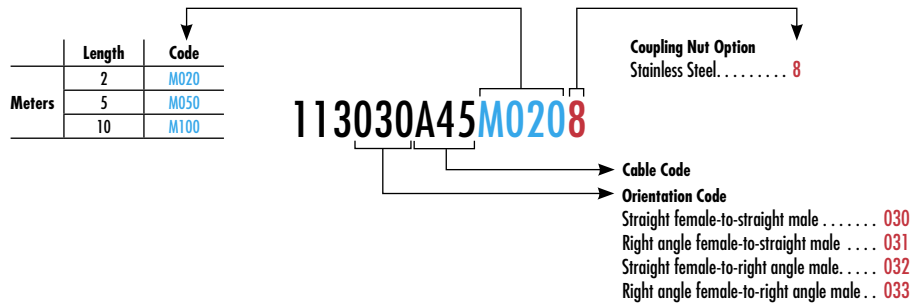

*Once an engineering number is created using the configuration code, consult Molex tech support for information regarding any part numbers.

Brad® Power Drop/Branch Receptacles

130066

Female, Male Straight



Features and Benefits

- Patented Quad Beam™ contact provides high reliability and low resistance
- Meets NFPA 79-2012 standards for motor and branch circuits
- UL 2237 (PVVA) listed

Reference Information

UL File No.: E258922

Electrical

Voltage: 600V AC/DC

Mechanical

Wire Type: THHN

Physical

Connector Face: PVC

Shell: Black epoxy-coated Zinc or anodized Aluminum

Mounting Thread Size: 1/2" - 14 NPT

Panel Mount: Front

Environmental

Protection: IP67, IP68 (IP69K with Stainless Steel)

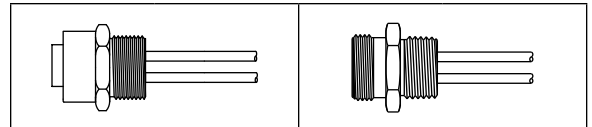

Poles (Female View)	Current	Wire Size AWG	Female Straight		Male Straight	
			Engineering No.	Standard Order No.	Engineering No.	Standard Order No.
3 Pole 1 - Green/Yellow-gnd 2 - Black 3 - White	13.0A	16	1R3000A20M005G	130066-0281	1R3006A20M005G	130066-0263
	15.0A	14	1R3000A28M005G	130066-0035	1R3006A28M005G	130066-0050
4 Pole 1 - Black 2 - White 3 - Red 4 - Green/Yellow-gnd	10.0A	16	1R4000A20M005G	130066-0254	1R4006A20M005G	130066-0078
	15.0A	14	1R4000A28M005G	130066-0069	1R4006A28M005G	130066-0090

Note: Sales drawings for all standard order numbers are available on molex.com

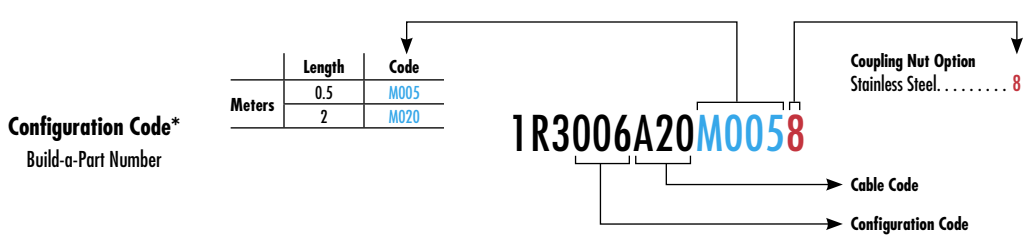

*Once an engineering number is created using the configuration code, consult Molex tech support for information regarding any part numbers.

Brad® Power Mini-Change® Drop/Branch Field Attachable Connectors

130017
Female, Male
Straight



Features and Benefits

- Patented Quad-Beam™ contact design for reliability and low resistance
- Allows easy field conversion to quick-connect or repair of damaged, molded connector

Reference Information

UL File No.: E258922

Electrical

Voltage: 600V AC/DC

Mechanical

Wire Size: 15 to 24 AWG

Cable Range: 5.08 to 11.43mm (.200 to .450")

Physical

Connector Face: Polyurethane

Connector Body: Nylon

Contact: Brass with Gold over Nickel plating

Coupling Nut: Nickel-plated Brass

Operating Temperature: -20 to +80° C

Environmental

Protection: IP67

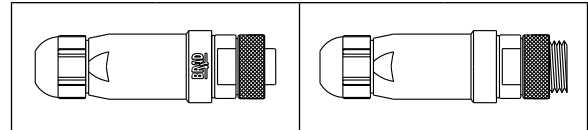

Poles (Female View)	Current	Female Straight		Male Straight	
		Engineering No.	Standard Order No.	Engineering No.	Standard Order No.
3 Pole 	15.0A	1A3000-34PWR	130017-0055	1A3006-34PWR	130017-0056
4 Pole 	15.0A	1A4000-34PWR	130017-0057	1A4006-34PWR	130017-0058

Note: Sales drawings for all standard order numbers are available on molex.com

Brad® Power Trunk/Feeder Accessories

- Features and Benefits**
- Protects connector from dust and moisture

130070 Closure Cap/Locking Clip



Product Name	Description	Engineering No.	Standard Order No.	Engineering No.	Standard Order No.	Engineering No.	Standard Order No.
Closure Cap	1 3/8" - 16 UN-2A External Thread, Anodized Aluminum	55-0198	130070-0018				
	1 3/8" - 16 UN-2B Internal Thread, Anodized Aluminum			55-0298	130070-0019		
Locking Clip	Snap Lock, Tool to Release (Pkg of 10)					66200A-10	130070-0020

Brad® Power Drop/Branch Accessories

- Features and Benefits**
- Protects connector from dust and moisture

130201/130070 Closure Cap/Locking Clip

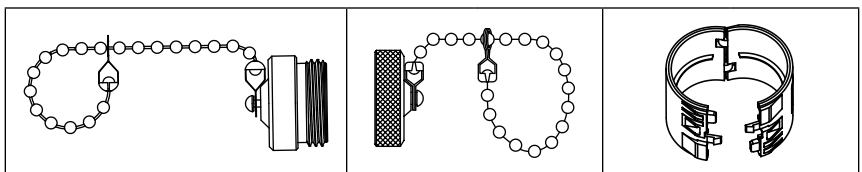

Product Name	Description	Engineering No.	Standard Order No.	Engineering No.	Standard Order No.	Engineering No.	Standard Order No.
Closure Cap	7/8" - 16 UN-2A External Thread, Anodized Aluminum with Steel Bead Chain	65-0085	130201-1109				
	7/8" - 16 UN-2B Internal Thread, Anodized Aluminum with Steel Bead Chain			65-0086	130201-1111		
Locking Clip	Snap Lock, Tool to Release (Pkg of 10)					11400A-10	130070-0012

Brad® Mini-Change® and Micro-Change® (M12) Emergency Stop Cordsets and Tees

130010/130018
Special Wired



Features and Benefits

- Patented Quad Beam™ contact with Gold over Nickel plating provides high reliability and low resistance
- Compatible with Allen-Bradley ArmorStart drives*

Reference Information

UL File No. E152210
CSA File No. LR6837

Physical

Connector Face: TPE
Connector Body: TPE
Contacts: Brass with Gold over Nickel plating
Hardware: Black epoxy-coated Zinc
Operating Temperature: -20 to +80° C

Environmental

Protection: IP67

E-stop Cordset (Mini-Change-to-Mini-Change)

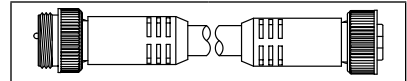

Male	Schematic	Female	Current	Voltage	Cable Type	Male Straight-to-Female Straight	
						Engineering No.	Standard Order No.
			8.0A	600V	TC-ER	51180-M020	130018-0125

E-stop Adapter Cordset (Mini-Change-to-Micro-Change)

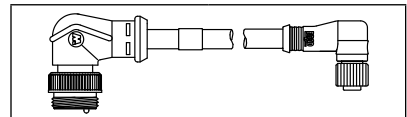

Male	Schematic	Female	Current	Voltage	Cable Type	Male-Female Right Angle-to-Right Angle	
						Engineering No.	Standard Order No.
			4.0A	300V	ITC-ER	41627-M010	130010-1657

Tee for E-stop In (Mini-Change)

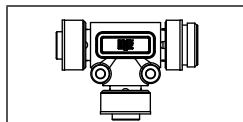

Schematic	Current	Voltage	Engineering No.	Standard Order No.
	8.0A	600V	61451-ESIN	130035-0030

Tee for E-stop Out (Mini-Change)

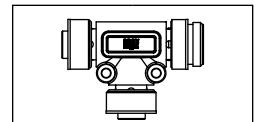

Schematic	Current	Voltage	Engineering No.	Standard Order No.
	8.0A	600V	61451-ESOUT	130035-0031

Note: Sales drawings for all standard order numbers are available on molex.com
*Allen-Bradley and ArmorStart are trademarks of Rockwell Automation Inc.

Configuration Code†
Build-a-Part Number

	Length	Code
Meters	2	M020
	5	M050
	10	M100

51180-M020

†Once an engineering number is created using the configuration code, consult Molex tech support for information regarding any part numbers.

Brad® Mini-Change® Emergency Stop Receptacles and Terminators

130010/130018
Special Wired

Features and Benefits

- Patented Quad Beam™ contact with Gold over Nickel plating provides high reliability and low resistance
- Compatible with Allen-Bradley ArmorStart drives*

Reference Information

UL File No.: E152210
CSA File No.: LR6837

Physical

Connector Face: TPE
Connector Body: TPE
Contacts: Brass with Gold over Nickel plating
Hardware: Zinc die-cast with black epoxy
Mounting Thread Size: 1/2" - 14 NPT
Panel Mount: Front
Operating Temperature: -20 to +80° C

Environmental

Protection: IP67



Female Receptacle

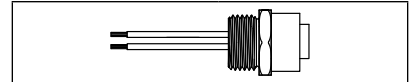

Female	Schematic	Current	Voltage	Wire Type	Female Straight	
					Engineering No.	Standard Order No.
6 Pole 		8.0A	600V	UL 1015	41671-0030	130013-0991

E-stop In Terminator

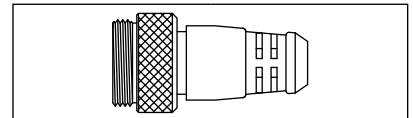

Male	Schematic	Current	Voltage	Male	
				Engineering No.	Standard Order No.
6 Pole 		8.0A	600V	41437-001	130039-0358

E-stop Out Terminator

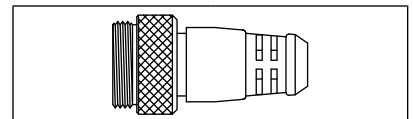

Male	Schematic	Current	Voltage	Male	
				Engineering No.	Standard Order No.
6 Pole 		8.0A	600V	41437-002	130039-0359

*Allen-Bradley and ArmorStart are trademarks of Rockwell Automation Inc.

Network Solutions

DeviceNet*	224 to 225	Micro-Change® (M12) and Ultra-Lock®	
Remote Scanners	226	Cordsets (US)	323 to 324
Diagnostic Tools	227	Cordsets (Europe)	325 to 326
Interface Cards	228	Receptacles (US)	327
Interface Modules	229-230	Receptacles (Europe)	328
Common Industrial Safety Software Kits	231	Field Attachable Connectors	329
I/O Modules	232 to 233	Ethernet	330
Bulk Cables	234 to 237	Development Kits	332 to 333
Mini-Change®		Windows* Compatible Drivers	334 to 335
Cordsets	238 to 244	Network Interface Cards	336 to 337
Receptacles	245 to 247	Communication Modules	338
Field Attachable Connectors	248	I/O Modules	339 to 340
Terminator Resistors	249	Common Industrial Safety Software Kits	341
Tees and Adapters	250 to 253	Ethernet Switches	342 to 343
Passive Multi-Ports	254 to 255	RJ-Lnxx® RJ-45 and Standard RJ-45	
Micro-Change® (M12)		Cordsets	344 to 348
Cordsets	256 to 261	Receptacles	349 to 353
Receptacles	262 to 263	Field Attachable Connectors	354
Field Attachable Connectors	264	Accessories	354
Terminators	265	Sealed RJ-45	
Tees and Splitters	266	Cordsets	355 to 357
Passive Multi-Ports	267 to 268	Receptacles	358
Open Style		Field Wireable Connectors	359
Cordsets	269 to 270	Dust Caps	359
Receptacle Assemblies	271	Micro-Change® (M12)	
Nano-Change® (M8)		Cordsets	360 to 363
Cordsets	272 to 276	Field Attachable Connectors	364
Passive Multi-Ports	277	Ultra-Lock®	
Auxiliary Power Media		Cordsets	365 to 366
Mini-Change®		Receptacles	367 to 370
Cordsets	278	Micro-Change® (M12)	
Adapters	279	Adapters	371
Field Attachable Connectors	280	Circular Hybrid Technology Connector	372
Power Taps	281	X-Coded	373 to 374
Machine Stop Tees	282	Other Networks	376
Micro-Change® (M12) and Ultra-Lock®		Communication Modules	378
Cordsets	283 to 284	Interface Cards	379 to 381
Receptacles	285	Windows Compatible Protocol Drivers	382
Field Attachable Connectors	286	I/O Modules	383
PROFIBUS†	288	PICS Simulation Software	384
Adapters	290	NMEA 2000*	385
Interface Cards	290 to 297	Bulk Cables	386
Communication Modules	298 to 299	Micro-Change® (M12)	
Industrial Gateway	300	Cordsets	387 to 389
I/O Modules	301 to 302	Receptacles	390
Cables	303	Field Attachable Connectors	391
Micro-Change® (M12)		Terminator Resistors	392
Cordsets	304 to 306	Tees	393 to 394
Receptacles	307 to 309	Junction Boxes	395
Field Attachable Connectors	310	Mini-Change®	
Terminators	311	Cordsets	396
Tees	312	Field Attachable Connectors	397
D-Sub		Terminator Resistors	398
Field Attachable Connectors	313	Tees	399
Cordsets	314 to 318	Power Tap	400
Auxiliary Power Media		Auxiliary Power Media Cordsets	401
Mini-Change®		Micro-Change® (M12) and Mini-Change®	
Cordsets	319	Receptacles	402
Receptacles	320	Closure Caps	402
Field Attachable Connectors	321	Industrial USB	403
Tees	322	Cordsets	404 to 405
		Receptacles	406
		Dust Cap	407

*DeviceNet is a trademark of Open DeviceNet Vendor Association (ODVA).

†PROFIBUS is a trademark of PROFIBUS International.

*Windows is a registered trademark of Microsoft Corporation.

*NMEA 2000 is a trademark of the National Marine Electronics Association

Network solutions

Our line of Brad® communication and control products is designed to support and facilitate the networks that automate today's and tomorrow's premier global industrial applications. Molex supports the most popular industrial networks and fieldbuses—Ethernet, DeviceNet*, PROFIBUS† and legacy with a variety of products and solutions. Through its leading connectivity brands, Brad products give the user and designer a complete communication and connectivity solution—from network interface cards for PC-based HMI/supervision, PLC communication modules for fieldbus control up to IP67 infrastructure to connect on-machine I/O devices. Molex brings the flexibility which is scalable based on your needs and applications. Upgrade to a total system solution by incorporating Brad communications and Brad control products.

*DeviceNet is a trademark of Open DeviceNet Vendor Association (ODVA).
†PROFIBUS is a trademark of PROFIBUS International.



DeviceNet

Brad® and DeviceNet™

Brad® automation products give the designers and users of a DeviceNet™ system a complete communication and connectivity solution—from scanner through media infrastructure to IP67 I/O connections and diagnostics. No other supplier provides a comprehensive backbone of connectivity while giving you the power to choose other elements of the control system. You select which control engine you want, whether it be PC- or PLC-based. You choose which control architecture—centralized or distributed—which type of motor controllers, valve banks or sensors you want. Brad insures connectivity to all these devices.

PROFIBUS†

Brad® and PROFIBUS

Brad® products give the user and designer of a PROFIBUS system a complete communication and connectivity solution—from scanner card to media infrastructure to IP67 I/O connections. You can select which control engine you want, whether it is PC- or PLC-based; we get you onto the network. You can choose which control architecture—centralized or distributed—that makes the most sense to you. Whether you are connecting motor controllers, valve banks or sensors, we ensure that connectivity to those points are there.

Ethernet

Brad® and Ethernet

Brad® ethernet products provide solutions that enable the world's most popular Local Area Network to be reliably utilized on the factory floor or in harsh commercial environments. The Brad line offers a large choice of products including physical media, IP67 I/O modules, unmanaged and managed switches, powerful network interfaces, industrial gateways and protocol development kits to connect the most popular Ethernet industrial networks and fieldbuses. Brad Ethernet products give the user a complete communication and connectivity solution to design a large scope of industrial applications—PC-Based control, supervision, data storage, protocol bridging, etc.—to suit all industry sectors.

Other Networks

Brad® and Other Networks

The Brad® product portfolio covers more than 40 industrial protocols including current and legacy networks such as Modbus, CANopen, Serial, AS-interface, and CC-Link. Brad products offer users a complete communication and connectivity solution—from software drivers, interface cards, PLC communication modules, industrial gateways, IP67 digital I/O modules and network media. With over 20 years of experience and technical expertise in industrial communication and control, Molex is a dependable partner. Brad systems are installed around the world in sectors as varied as petrochemical, automotive, food processing and building management. Brad product lines are developed in compliance with the standards and specifications published by international organizations to guarantee a high level of performance, reliability and availability.



Brad® DeviceNet



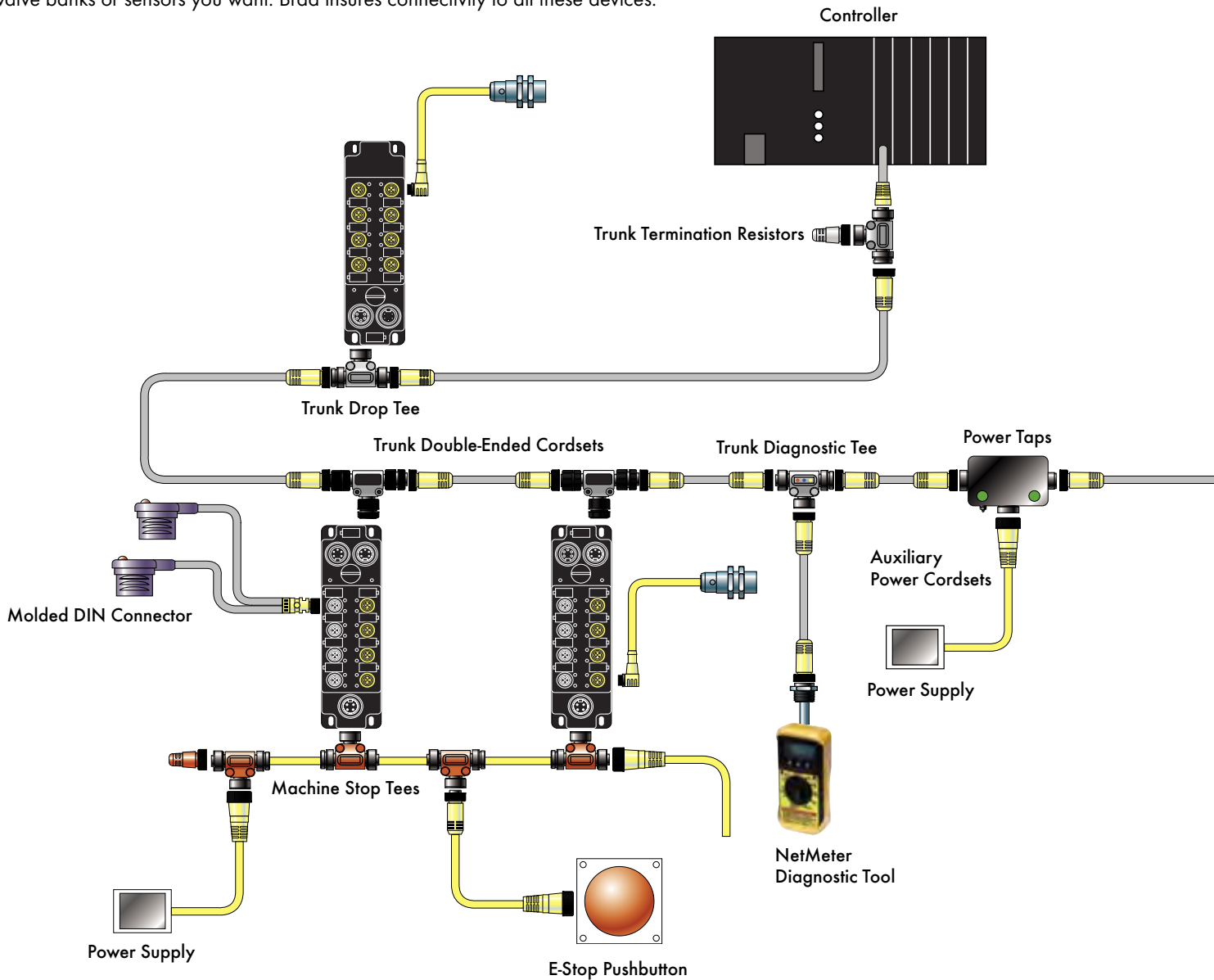

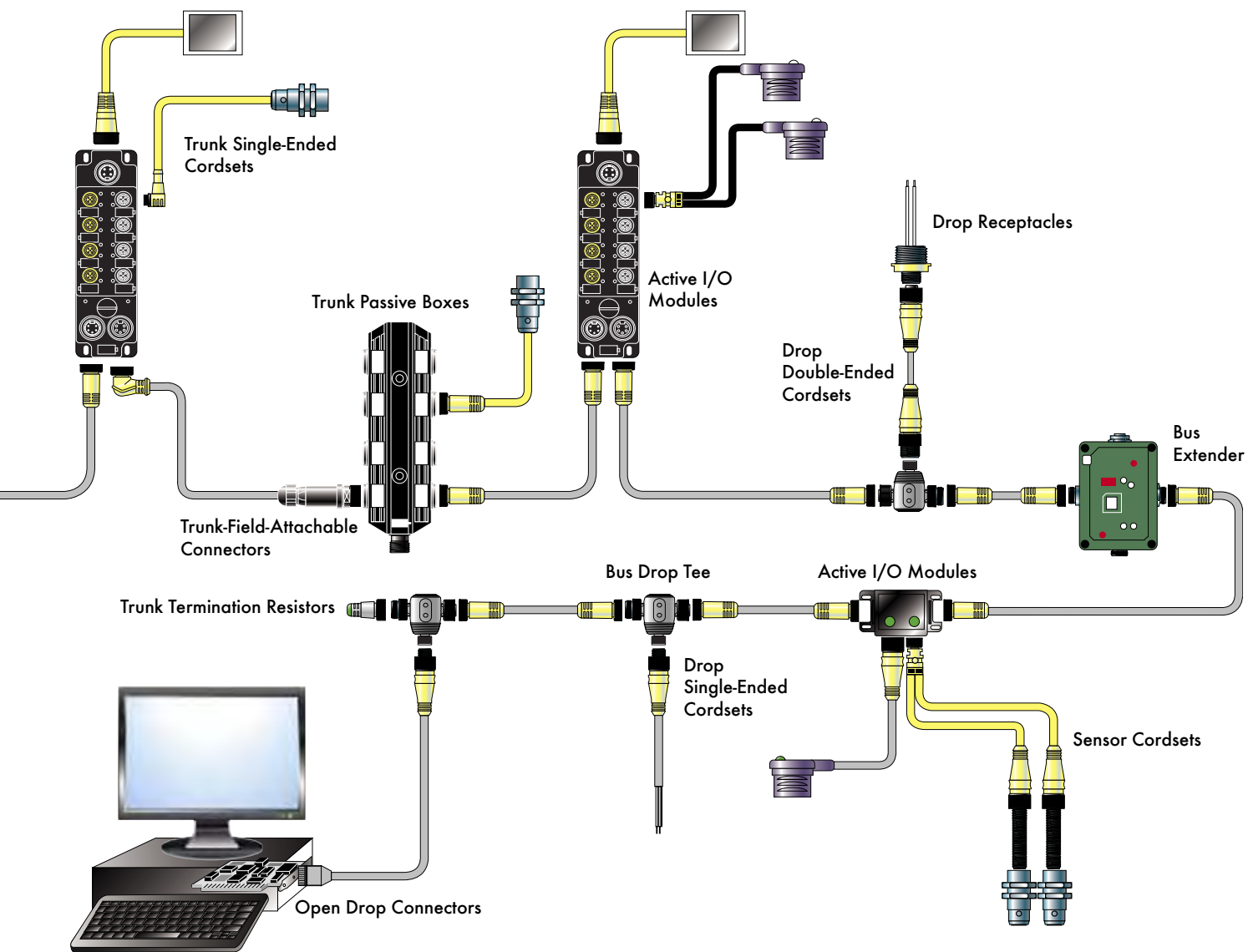





Brad® automation products give the designer and users of a DeviceNet system a complete communication and connectivity solution—from scanner through media infrastructure to IP67 I/O connections and diagnostics. No other supplier provides a comprehensive backbone of connectivity while giving you the power to choose other elements of the control system. You select which control engine you want, whether it be PC- or PLC-based. You choose which control architecture—centralized or distributed—which type of motor controllers, valve banks or sensors you want. Brad insures connectivity to all these devices.





PC-Based
Control/HMI/
SCADA

Components and Elements of DeviceNet System

- | | | | |
|---|-------------------|---|-----------------|
|  | Controller |  | Thick Media |
|  | I/O Devices |  | Thin Media |
|  | IP67 I/O Modules |  | Power Media |
|  | Media |  | Cordsets |
|  | Network Interface |  | I/O Connections |

Brad® SST™ DeviceNet™ Remote Scanner

112034

DeviceNet Control over Ethernet



Features and Benefits

- High performance DeviceNet protocol executed via up to 16 Remote DeviceNet Scanners
- User interface DLL/API is completely backward compatible with existing applications and local DeviceNet interface cards
- Diagnostic LEDs
- UCMM (Unconnected Message Manager) capable; Group 1, 2, and 3 dynamic explicit connections supported
- Provides simultaneous execution of Group 2 Client (Master) and Server (Slave) operation
- Supports all DeviceNet standard baud rates: 125, 250, and 500 Kbaud
- Supports Poll, Strobe, Change of State (COS) and Cyclic I/O messaging
- Provides Client (Master) explicit messaging to slave devices
- Backward compatible DLL preserves existing investment
- DIN rail mount allows distribution to machine level
- Frees up PC slots by placing scanner cards remotely
- Manage your DeviceNet application across an Ethernet LAN
- Capable of updating DeviceNet I/O faster than a PCI version
- Reduce infrastructure costs by using cheaper Ethernet cable and fewer and/or less expensive PCs

OS and Drivers Supported

- Microsoft® Windows XP, Vista and 7 (32/64-bit) drivers
- Diagnostic tools
- Example C source code and Windows DLLs for custom driver development

Software Tools

Diagnostic and test tools are available that enable fast integration of industrial communication into your application.

Hardware Specifications

- Diagnostic LEDs:
 - Remote Scanner—Power, system status
 - DeviceNet—Power, communication, health
 - Ethernet—Link, 10/100 Mbaud, activity
- Remote Scanner Power: 10–30VDC, 330mA typical (male Nano-Change® M8 connector)
- RoHS Compliant: Yes
- Approvals: CE, ODVA DeviceNet Conformance

Environmental

- Humidity: 5 to 95% non-condensing

Network Specifications

- Protocol:
 - DeviceNet Master—Group 2 Client, Group 2 only Client
 - DeviceNet Slave—Group 2 Server
 - Isolated CAN physical layer on each channel
- Cable:
 - DeviceNet—shielded twisted pair, compatible with target network
 - Ethernet—Cat 5e shielded
- Connector:
 - DeviceNet—Compliant male Micro-Change® M12 connector
 - Ethernet—RJ45
- DeviceNet Power: 11-24 VDC, 50 mA typical
- Isolation: 500 V
- Data Rate:
 - DeviceNet—125 Kbps, 250 Kbps and 500 Kbps
 - Ethernet—10/100 Mbps

Physical

- Operating Temperature: 0° to +50° C
- Storage Temperature: -40 to +85° C

Product Description	Engineering No.	Standard Order No.
Remote DeviceNet Scanner (without cables)	SST-EDN-1	112034-0021
Remote DeviceNet Scanner with cable kit (DeviceNet and Power) Single-ended power cable: 3-pole, M8 connector on one end, 2 meters (6.6ft), UL/CSA cable, Cat. No. 120086-0102 (403000A10M020) Single-ended DeviceNet cable: 5-pole, M12 connector on one end, 2 meters (6.6ft), UL/CSA cable, Cat. No. 130027-0049 (DND20A-M020)	SST-EDN-1-C2	112034-0026

Brad® DeviceNet™ Diagnostic Tools

112008 eNetMeter™ DN
112008 NetAlytix™
112008 NetMeter®



Quickly identify problems relating to network power, data errors and excessive bandwidth consumption for your DeviceNet network.

eNetMeter DN and NetAlytix

eNetMeter DN is a passive device that continuously monitors a DeviceNet network and sends the information over Ethernet to a PLC or PC monitoring system. The information can be used to proactively respond to out-of-tolerance parameters before network failure occurs. Optionally, data can be accessed through NetAlytix software, an OPC server or a DLL.

NetMeter

NetMeter cuts troubleshooting time by providing technical details, yet it simplifies and summarizes, allowing both a DeviceNet expert and novice to effectively identify and diagnose network problems. It summarizes DeviceNet bus health by displaying a happy face icon, indicating a healthy network; a sad face, indicating a serious problem; or a neutral face, indicating nominal performance (a good indication to repair things before they actually fail). NetMeter then walks the user through each fault condition and its potential source.

eNetMeter DN and NetAlytix

Features and Benefits

- Continuously monitors a DeviceNet network in a passive state
- Provides feedback to an EtherNet/IP* master or one of three methods to a personal computer (PC) residing on Ethernet:
 - NetAlytix™ software
 - OPC server
 - DLL interface
- High-speed sampling of network parameters
 - Signals are sampled millions of times per second providing accurate values
- Information captured includes:
 - Overall network status and measurements
 - Individual node status and measurements
 - Detailed measurements of power (V+, V-), signal (CANH, CANL) and shield parameters
- Warning and fault flags indicate when a value has exceeded a set tolerance (levels are customizable)
- NetAlytix software enables quick graphical access to network issues including CAN and power waveform details

Electrical

Input Power (Aux. or DeviceNet)
11 to 25V DC, 300 mA (typical at 24 VDC)
Data Rate: DeviceNet: 125K, 250K and 500K baud
Ethernet: 10/100 M baud

Mechanical

Diagnostic LEDs and Control: Ready, System/Boot, Power & Comm; Reset (recessed)

Physical

Dimensions: 142.00mm (5.60") high;
102.00mm (4.08") deep;
38.00mm (1.53") wide
Connectors: DeviceNet—5-pole M12 Micro-Change®
Ethernet—RJ-45
Enclosure: IP20
Mounting: DIN rail or panel (screw) mounted
USB: USB 2.0 master, for transfer/storage of configuration parameters
Operating Temperature: 0 to 60° C
Storage Temperature: -5 to 75° C
Humidity: 5 to 95% non-condensing

Compliance

Approvals: CE, cULus, ODVA EtherNet/IP Conformance
RoHS Compliant: Yes

NetMeter

Features and Benefits

- Certifies proper network operation:
 - Measures 677 key network parameters
 - Compares with DeviceNet specification
- Battery-powered:
 - Save readings for off-line analysis
- Accelerates fault troubleshooting:
 - AutoSearch finds all bad network parameters
 - Full traffic and error analysis by node address
 - Power quality, shield voltage, signal quality

Electrical

Power supply: 7V—30V (30 mA at 24V)
Battery 2x AA Alkaline (for offline review of stored measurements)

Mechanical

Baud Rates Supported: 125K, 250K, 500K (auto-detect)
Analog Range (with over/under range indication):
Bus Power: 0 to 25V
Bus Signal: -5 to 10V

Physical

Connectors: DeviceNet* Standard "Sealed Micro"
Adapter cable included for DeviceNet Standard "Sealed Mini"



Product Description	Engineering No.	Standard Order No.
eNetMeter DN diagnostic tool for DeviceNet	SST-ENM-DN1	112008-0008
NetAlytix software for eNetMeter DN (includes full application, DLL/API, OPC Server)	SST-NAS-DN1	112008-0011
Bundle of eNetMeter DN (112008-0008) and NetAlytix (112008-0011), with a limit of one per partner or end-customer site	SST-ENM-SKT	112008-0012
Bundle of eNetMeter DN (112008-0008) and NetAlytix (112008-0011) in portable test case (IP54) with DC power and external ports for network as well as AC power connections	SST-ENM-PTU	112008-0016
NetMeter for DeviceNet	DN-MTR (E)	112008-0013
NetMeter Kit for DeviceNet (includes carrying case, PowerMonitor T and LED Termination Resistor)	DN-MTR-KIT (E)	112008-0014
NetMeter carrying case	DN-MTR-BAG	112008-0003
NetMeter ISO calibration	DN-MTR-CAL	112008-0004

The diagnostic tools above are all endorsed within the Encompass Program by Rockwell Automation.
*EtherNet/IP is a trademark of ODVA (Open Device Vendor Association)

Brad® SST™ Network Interface Cards

112005 DeviceNet™ PC/104 Cards

112027 OPC Software Tools

112113 DeviceNet PCI Cards

112030 DeviceNet Software Tools



SST™ network interface cards (NICs) and software tools are used for high-speed control and monitoring applications on DeviceNet.

SST™ Network Interface Cards

DeviceNet NICs from Molex are ideal for applications where high-performance control and reliability are required. Backed by superior support and service, Molex network interfaces support a wide range of network protocols and bus formats.

SST network interface cards for DeviceNet can be found in many applications including:

- Human-Machine Interface
- PC Control
- OEM machine control (robotics, semiconductor, material handling)
- Device Development
- Network Diagnostics

SST NICs undergo DeviceNet conformance testing.

Features and Benefits

- Enhanced FPGA-based design
 - Lower component count for higher reliability
 - Extended product lifecycle
- Diagnostic LEDs
- Provides Quick-Connect functionality (Master mode)
 - Allows devices to be accessed on power-up in under 500 milliseconds
- Flexible communication support:
 - UCMM (Unconnected Message Manager) capable; Group 1, 2, and 3 dynamic explicit connections supported
 - Provides simultaneous execution of Group 2 Client (Master) and Server (Slave) operation
 - Supports all DeviceNet standard baud rates: 125, 250, and 500 Kbaud
 - Supports Poll, Strobe, Change of State (COS) and Cyclic I/O messaging
 - Provides Client (Master) explicit messaging to slave devices
 - Supports fragmented Explicit and I/O messages
- Support for CAN 2A and 2B (both 11 and 29 bit identifiers)
- Windows XP, Vista and 7 (32/64-bit) drivers provided
- Form-fit-function replacements for the DN3 family of NICs for DeviceNet
- Compatible with CIP Safety Stack from Molex (provided separately)
- Multi-Slave versions available (optional) to aid in system simulation (PCU format only)
- Software tools enable faster network commissioning and diagnosis of faults

Electrical

External Power: 11-24 VDC, 50 mA typical

Isolation: 500 V

Data Rate: Up to 1 Mbaud for CAN 125K, 250K and 500K baud for DeviceNet

Protocol

DeviceNet Master—Group 2 Client, Group 2 only Client

DeviceNet Slave—Group 2 Server

Compliant with DeviceNet Specification 1.8

CAN 2.0 B

Isolated CAN physical layer on each channel (where applicable)

Mechanical

PCI (PCU)

Bus Interface: 32-bit, 33 MHz, PCI universal 3.3/5V interface (compliant with PCI v2.2 and v2.3)

Processor: 64 MHz NIOS Processor

Memory: 128 bytes for PCI configuration

Diagnostics: Bi-color LEDs showing card status power, communication

Interrupts: Hardware Plug and Play (32 Kbytes used per card)

Typical Current Draw: +5V, ± 5%, 300mA (1 channel)

Addressing—Memory: 256 Kbyte window available per channel

Addressing—I/O: 16 bytes allocated per channel

PC/104

Bus Interface: 16-bit PC/104 interface (compliant with PC/104, v2.3 & v2.4)

Processor: 64 MHz NIOS Processor

Memory: 256 KB of shared RAM per channel

Diagnostics: Bi-color LEDs showing card status power, health, communication

Interrupts: Software selectable level

IRQ 2/9, 5, 7, 10, 11, 12, 15; standard TTL drive

Typical Current Draw: +5V, ± 5%, 600mA 2 channel

Addressing—Memory: 256K in a window of 8K, 16K, 32K, 64K, 128K or 256K bytes on even window boundary between 512K and 1Mb

Addressing—I/O: 8 bytes on any even 8-bit boundary from 200h-2F8h or 600h-6F8h

Physical

Dimensions —PCI (PCU):

Standard half-height (1 channel)

Standard full-height (2 channel)

Dimensions (LxW)—PC/104:

9.588 x 9.017cm (3.775 x 3.550")

Operating Temperature: 0 to +60° C (32 to 140° F)

Storage Temperature: -40 to +85° C (-40 to 185° F)

Cable: Shielded twisted pair, compatible with target network

Connector: DeviceNet compliant 5-pin CAN connector

Environmental

RoHS Compliant

Humidity: 5 to 95% non-condensing

Product Description	Engineering No.	Standard Order No.
DeviceNet card, Universal PCI bus (3.3V / 5V), 1 channel, full-height bracket	SST-DN4-PCU	112113-0007
DeviceNet card, Universal PCI bus (3.3V / 5V), 1 channel, half-height bracket	SST-DN4-PCU-H	112113-0001
DeviceNet card, Universal PCI bus (3.3V / 5V), Multi-Slave, 1 channel	SST-DNMS4-PCU	112113-0009
DeviceNet card, Universal PCI bus (3.3V / 5V), Multi-Slave, 1 channel, half-height bracket	SST-DNMS4-PCU-H	112113-0010
DeviceNet card, Universal PCI bus (3.3V / 5V), 2 channels	SST-DN4-PCU-2	112113-0005
DeviceNet card, PC/104, 1 channel	SST-DN4-104-1	112005-0040
DeviceNet card, PC/104, 2 channels	SST-DN4-104-2	112005-0048

SST™ DN4 DeviceNet* USB Interface Module

112076 USB Interface Module



Molex's compact SST DN4 DeviceNet USB interface module uses an enhanced FPGA design to maximize performance in control and monitoring applications

The SST DN4 DeviceNet USB module from Molex was developed to provide industrial OEMs and end-users with a compact, high-performance DeviceNet interface for PC communication. Ideal for use in control and monitoring applications, Molex's USB design is the result of 15 years of DeviceNet product expertise.

The SST DN4 USB interface module uses an enhanced FPGA (Field Programmable Gate Array) design with a lower component count, resulting in an extended product lifecycle and higher reliability.

Features and Benefits

- Scans DeviceNet in 3 to 5 milliseconds for a high-performance module for control applications
- Provides simultaneous execution of Group 2 Client (Master) and Server (Slave) operations for applications where both capabilities may be required

Features and Benefits (continued)

- Supports poll, strobe, change-of-state (COS) and cyclic input/output messaging flexibility for any DeviceNet control scheme
- QuickConnect capability in Client (Master) mode ensures devices may be accessed faster on power-up (in under 500 milliseconds)
- Used in Controller Area Network (CAN) networks (2A, up to 1Mb per second), and DeviceNet networks (at 125, 250 or 500kB per second); one device supports multiple networks
- SST DN4 USB interface module is a functional replacement for the DNP PCMCIA cards providing backward compatibility with DNP cards
- Conformance tested to ODVA standards (Volume 3, v.1.8 for DeviceNet) meeting industry standard requirements

Operating Systems and Drivers Supported

- Windows XP/Vista/7 drivers (32/64-bit)
- The Console; a grouping of software tools including OPC server configuration and diagnostic tools
- Open, documented memory map interface with example C source code and Windows DLLs for custom driver development

Reference Information

cULus, CE
FCC (Part 15, Subpart B—Class A)

Electrical

Processor: 64 MHz NIOS Processor
Addressing I/O: Up to 500 bytes of input data and 500 bytes of output data per I/O connection as a DeviceNet master or slave
Current Draw (USB): 4.75 to 5.25V DC, 80mA max. typical
Protocol: DeviceNet Master—Group 2 Client, Group 2 only Client
DeviceNet Slave—Group 2 Server
Compliant with ODVA DeviceNet Specification 1.8
Compliant with CAN 2.0 A

Electrical (continued)

External Power: 11 to 25V DC, 60mA max.
Isolation: Isolated CAN physical layer 500V DC
Data Rate: Up to 1M baud for CAN 125K, 250K and 500K baud for DeviceNet

Physical

Bus Interface: USB High-Speed 2.0 compatible standard
USB Type B receptacle

Dimensions: Width—102mm (4.016")
Depth—54.0mm (2.126")
Height—30.0mm (1.181")

Cable: Shielded twisted pair, compatible with target network

Connector: DeviceNet compliant 5-pin CAN connector

Diagnostics: LEDs showing card status health (tri-colour) and communication (bi-colour)

Humidity: 5 to 95% non-condensing

Operating Temperature: 0 to +60° C (+32 to +140° F)

Storage Temperature: -40 to +85° C (-40 to +185° F)

Environmental

RoHS

Markets and Applications

- Applications
 - I/O blocks
 - PC control systems
 - HMI/SCADA (Human Machine Interface/Supervisory Control and Data Acquisition) systems
 - Robot and other machine control
 - Diagnostics
- Markets
 - Automotive
 - Semiconductor
 - Material handling
 - Pulp and paper
 - Food and beverage
 - Mining and metals

SST™ DN4 DeviceNet USB Interface Module

Description	Engineering No.	Standard Order No.
DeviceNet USB interface with 5-pin connector	SST-DN4-USB	112076-0001
DeviceNet USB interface with 5-pin to M12 Sealed Micro connector	SST-DN4-USB-SM	112076-0002

Note: SST™ DeviceNet remote diagnostic software is included with each module

*DeviceNet and CIP are trademarks of ODVA

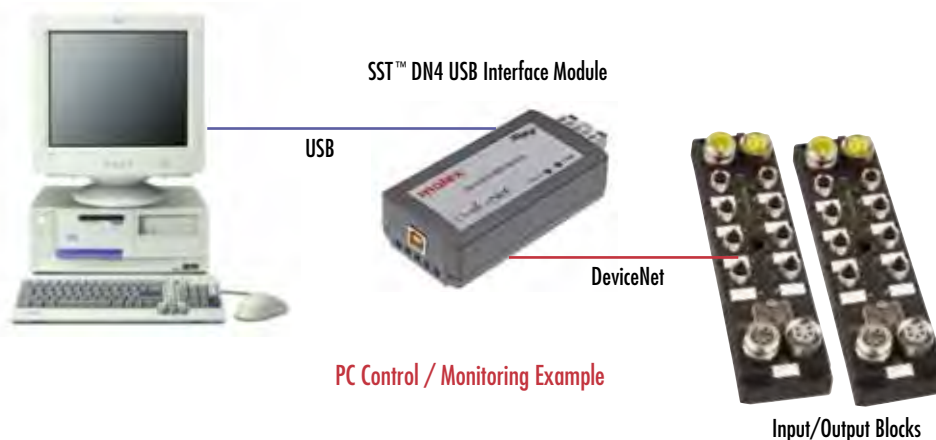

SST™ DeviceNet* Software Tools

112027/112030

DeviceNet Software Tools

Software available for the SST DeviceNet interfaces enables fast integration of industrial communication within a customer's application.

Operating Systems and Drivers Supported

- Windows XP/Vista/7 drivers (32/64-bit)
- The Console; a grouping of software tools including OPC server configuration and diagnostic tools
- Open, documented memory map interface with example C source code and Windows DLLs for custom driver development



DeviceNet Software Console Tools and OPC Server

Key	Engineering No.	Standard Order No.
USB (single license)	SST-DN3-CNF-U	112030-0007
(single license)	SST-DN3-OPC	112027-0014

*DeviceNet and CIP are trademarks of ODVA

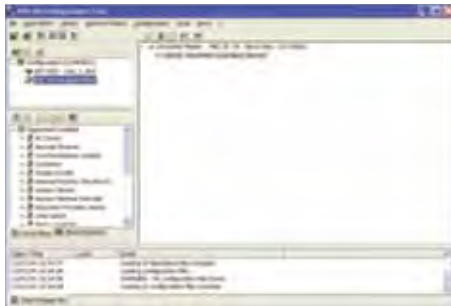

Configuration Console



OPC Server



Diagnostic and Test Tools
(included with DN3/DN4 DeviceNet cards)

Brad® Common Industrial Protocol (CIP*) Safety Software Kit (Stack)

112115/112116/112117
DeviceNet* and EtherNet/IP*
Stack Development Kits



Molex demonstrates market leadership with the comprehensive CIP Safety Stack software solution, allowing industrial-device manufacturers to embed CIP Safety Stack technology quickly and economically within their products.

Common Industrial Protocol (CIP) Safety is a protocol extension developed by the ODVA. The CIP Safety protocol offers a set of highly-integrated safety services which leverage the underlying communications stacks of the standard CIP networks to transport data from a source to a destination. CIP Safety allows end-users to implement safety systems in a more integrated, cost-effective manner. The Molex CIP Safety Software Kit (also called Stack) is offered as a tool kit, with the stack provided as modular "C" code that is pre-tested. The software allows a manufacturer of intelligent industrial products to implement the necessary safety-application layer that enables products to comply with the CIP Safety specification (Edition 2.1) from ODVA. The CIP Safety Stack is available for both DeviceNet* and EtherNet/IP*, and both are endorsed by Rockwell Automation under the Value Added Design Partner program.

The CIP Safety Stack is approved by TÜV for SIL3 applications and it has been conformance tested using the ODVA Conformance Test. Molex can support customers that request assistance with design implementation and/or guidance through TÜV approval.

Features and Benefits

- Meets IEC 61508, SIL3 ensuring international market acceptance
- Approved by TÜV and tested by ODVA means a high-quality solution for minimal project risk and faster time-to-market
- Pre-tested modular ANSI C code is easy to compile using standard compilers; faster time-to-market
- Molex engineers can support protocol-integration requests minimizing investment required for in-house resources
- Designed for use with other Molex/Brad offerings: Hardware (DN4 network interface cards), Software (DeviceNet or EtherNet/IP software stacks) which results in a complete CIP communication solution

Specifications

- ANSI C code is provided for the safety portion of the Stack (Compliant with CIP Safety Specification 2.1)
- ANSI C code for black-channel components (NET_CTRL_IO)
- Interface specification for high-integrity and black-channel environments
- Safety integration manual (including safety measure requirements)
- Optionally, modified standard CIP stacks (software/firmware) for DeviceNet (Slave) or EtherNet/IP (Adapter)
- Optionally, ANSI C code for the Platform Adaptation Layers (both safety and non-safety)
- Documentation required by certification bodies (TÜV, ODVA)
- Support during certification process of vendor's final product

Markets and Applications

- Industrial Device Manufacturers
 - I/O blocks
 - Valves
 - Drives
 - Complex machines (OEM)
- End-Users
 - Automotive
 - Consumer goods
 - Heavy industries

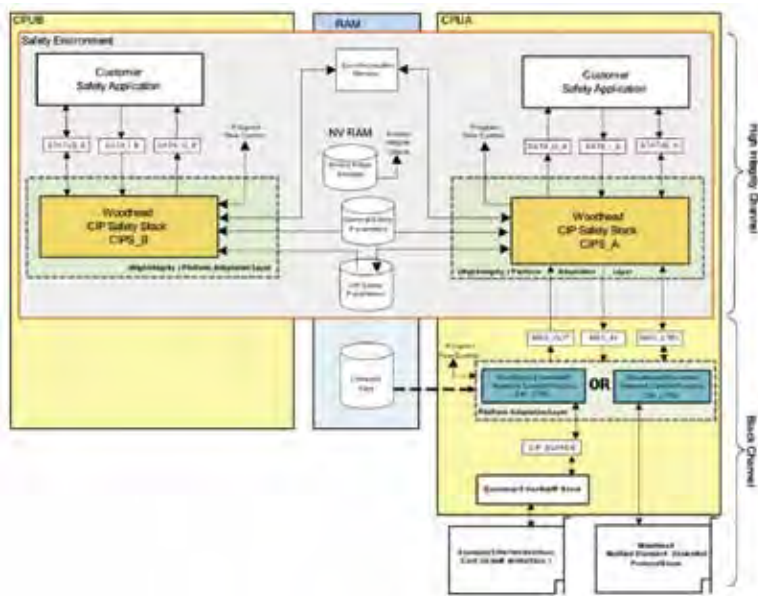

CIP* Safety Software Stack Concept for a Slave (Adapter) Application

Device Type	Network	Description	Engineering No.	Standard Order No.
Slave	DeviceNet	Stack Development Kit (Standard Source Code)	SDK-DNS-SAF	112115-0001
		Stack Development Kit (Source Code Obfuscation [†])	SDK-DNS-SAF-O	112115-0002
		Royalty (per device)	SDK-DNS-SAF-L	112116-0001
Adapter	EtherNet/IP	Stack Development Kit (Standard Source Code)	SDK-EIP-ADP-SAF	112117-0001
		Stack Development Kit (Source Code Obfuscation [†])	SDK-EIP-ADP-SAF-O	112117-0002
		Royalty (per device)	SDK-EIP-ADP-SAF-L	112116-0002
Slave and Adapter	DeviceNet and EtherNet/IP	Stack Development Kit (Standard Source Code)	SDK-DEP-SAP-SAF	112115-0003
		Stack Development Kit (Source Code Obfuscation [†])	SDK-DEP-SAP-SAF-O	112115-0004
N/A	N/A	Engineering Support	SDK-CIP-EDS-SAF	112115-0005

*CIP, DeviceNet and EtherNet/IP are trademarks of ODVA, Inc.

†Note: Source code obfuscation means that the "C" code is protected, but the compiler can process it.

Brad® HarshIO 600

112092

Digital IP67 IO Module Classic Format



Features and Benefits

- Reliable solution for connecting industrial controllers to IO devices in harsh duty environments.
- Accepts M12 threaded connectors or Brad Ultra-Lock® Push-Pull connection system
- Standard hole housing pattern allows for interchangeability with popular IO modules
- Visible LEDs provide maintenance personnel with the ability to easily determine IO, module and network status
- Support of QuickConnect (Fast Boot) for robot tool changer application

Description

- Rated IP67 for harsh environments
- Designed for direct machine mount applications
- Sixteen digital input/output per module
- Supports PNP and NPN input devices
- Watchdog with output reply state

Compatible Protocols

- DeviceNet® Slave
- Supports ODVA Group 2 Server Slave functionality
- Supports ADR and Quick-Connect

Conformance

- IP67 according to IEC 60529
- Vibration: IEC 60068-2-6 conformance
- Mechanical Shock: 10G, 11ms, 3 axis
- CE
- UL
- cUL
- RoHS compliant
- ODVA certified

Technical Data

- IO Configurations:
 - 16 inputs
 - 8 inputs + 8 outputs
- IO Connectors: 8x M12 ports, Ultra-Lock M12 female 5-pole, internally threaded
- DeviceNet Connectors:
 - 1x Mini-Change® male, 5-pole
 - 1x Mini-Change female, 5-pole
- Power Connectors:
 - Power In—Male Mini-Change, 4-pole
 - Power Out—Female Mini-Change, 4-pole
- Power Requirements:
 - Module Input Power—24V DC
 - Module Output Power—24V DC, 2.0A max. per channel, 8.0A max. per module
- Input Type:
 - Compatible with dry contact and PNP or NPN 3-wire switches
 - Electronic short circuit protection
- DeviceNet Address: 0 to 63 by rotary switches
- Input Device Supply: 140mA per port at 25° C
- Output Load Current: 1.0A max. per channel, electronic short circuit protection
- Maximum Switching Frequency: 200 Hz
- Housing Dimensions: 60.00 by 220.00 by 20.00mm (2.36 by 8.66 by .780")
- Mounting Dimensions:
 - 37.50mm (1.480") horizontal on centers
 - 210.00mm (8.270") vertical on centers
 - Center hole
- Operating Temperature: -25 to +70° C
- Storage Temperature: -40 to +85° C

No. of Power Pin	IO Configuration		Input Channel Type	Engineering No.	Standard Order No.
	Input	Output			
4	16		NPN	TCDDN-8DON-10U	112092-0019
	8	8		TCDDN-888N-11U	112092-0020
	16		PNP	TCDDN-8DOP-10U	112092-0010
	8	8		TCDDN-888P-11U	112092-0009

Brad® HarshIO 600

112092

Digital IP67 IO Module Compact Format



Features and Benefits

- Reliable solution for connecting industrial controllers to IO devices in harsh duty environments.
- Accepts M12 threaded connectors or Brad Ultra-Lock® Push-Pull connection system
- Standard hole housing pattern allows for interchangeability with popular IO modules
- Visible LEDs provide maintenance personnel with the ability to easily determine IO, module and network status
- Support of QuickConnect (Fast Boot) for robot tool changer application

Description

- Rated IP67 for harsh environments
- Designed for direct machine mount applications
- Eight digital input/output per module
- Supports PNP and NPN input devices
- Watchdog with output reply state

Compatible Protocols

- DeviceNet® Slave
- Supports ODVA Group 2 Server Slave functionality
- Supports ADR and Quick-Connect

Conformance

- IP67 according to IEC 60529
- Vibration: IEC 60068-2-6 conformance
- Mechanical Shock: 10G, 11ms, 3 axis
- CE
- UL
- cUL
- RoHS compliant
- ODVA certified

Included Hardware/Software

- IO Configurations:
 - 8 inputs
 - 4 inputs + 4 outputs
- IO Connectors:
 - 4x ports, Ultra-Lock M12 female 5-pole, internally threaded
 - 8x ports, M8 female 3-pole threaded
- DeviceNet Connectors:
 - 1x M12 male, 5-pole
 - 1x M12 female, 5-pole
- Power Connectors: M12 Male, 5-pole, A-Coding
- Power Requirements:
 - Module Input Power—24V DC
 - Module Output Power—24V DC, 4.0A max.
- Input Type:
 - Compatible with dry contact and PNP or NPN
 - Electronic short circuit protection
- DeviceNet Address: 0 to 63 by rotary switches
- Input Delay: 3ms default or configurable (through EDS)
- Input Device Supply: 140mA per port at 25° C
- Output Load Current: 1.0A max. per channel, electronic short circuit protection
- Maximum Switching Frequency: 200 Hz
- Housing Dimensions: 30.00 by 175.00 by 20.00mm (1.18 by 6.89 by .78")
- Mounting Dimensions:
 - 23.00mm (0.91") horizontal on centers
 - 168.00mm (6.61") vertical on centers
- Operating Temperature: -25 to +70° C
- Storage Temperature: -40 to +85° C

Compact—M8

No. of Power Pin	IO Configuration		Input Channel Type	Engineering No.	Standard Order No.
	Input	Output			
5	8		NPN	TBDDN-880N-804	112092-0022
	8		PNP	TBDDN-880P-804	112092-0008

Compact—M12

No. of Power Pin	IO Configuration		Input Channel Type	Engineering No.	Standard Order No.
	Input	Output			
5	8		NPN	TBDDN-480N-80U	112092-0018
	4	4	NPN	TBDDN-444N-88U	112092-5004
	8		PNP	TBDDN-480P-80U	112092-0007
	4	4	PNP	TBDDN-444P-88U	112092-0006

DeviceNet* Brad® Bulk Cable 130039 Thick Cable

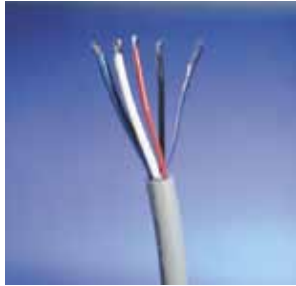

Features and Benefits

- Meets or exceeds ODVA specifications for highest system reliability

Reference Information

UL: Type CL2, VL 1581 flame resistance
CSA: AWM I/II and A/B FT4

Overall

Rating: 300V, 80° C
Materials: Power—Gray PVC outer jacket, PVC with nylon skin inner insulation
Data—PE foam inner insulation
Construction: Two shielded pairs with 18 AWG (19x30 AWG) drain wire between pairs

Power Pair

Wire: Two 15 AWG (19x28 AWG) stranded tinned Copper
Shielding: Aluminum outside/polyester tape 25% overlap
DC resistance: 3.6 ohms/1000 ft max. at 20° C
Current: 8.0A
Color Code: Red/Black

Data Pair

Wire: Two 18 AWG (19x28 AWG) stranded tinned Copper
Shielding: Aluminum outside/polyester tape 25% overlap
DC Resistance: 6.92 ohms/1000 ft max. at 20° C
Capacitance: 12pF/ft
Color Code: White/Blue

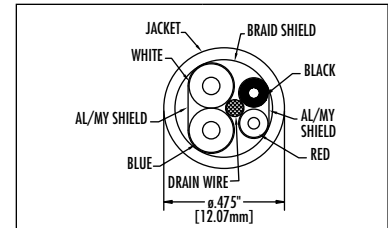

Cable Length	Max. Current	Max. Voltage	Engineering No.	Standard Order No.
50.0m (164.04')	8.0A	300V	DN00A-M500	130039-0368
100.0m (328.08')			DN00A-T100	130039-0369

Note: Sales drawings for all standard order numbers are available on molex.com
*DeviceNet is a trademark of Open DeviceNet Vendor Association (ODVA)

DeviceNet* Brad® Bulk Cable 130039 Thick Flex Rated Cable



Features and Benefits

- Meets or exceeds ODVA for highest system reliability
- Rated over 1.4M flex cycles—40% greater than most flex rated DeviceNet cabling

Reference Information

UL: CL3; AWM 20626, UL 1581
CSA: AWM I/II A/B 80° C 300V FT1

Overall

Rating: 300V, 80° C
Materials: Power—TPE outer jacket, PVC with nylon skin inner insulation
Data—PE foam inner insulation
Flexure: Rolling flex >1.4m cycles at 10x bend radius
Construction: Two shielded pairs with 18 AWG (19x30 AWG) drain wires between pairs

Power Pair

Wire: Two 15 AWG (19x28 AWG) individually-tinned Copper
Shielding: Aluminum outside/polyester tape 25% overlap
DC Resistance: 3.6 ohms/1000 ft max. at 20° C
Current: 8.0A
Color Code: Red/Black

Data Pair

Wire: Two 18 AWG (19x30 AWG) individually-tinned Copper
Shielding: Aluminum outside/polyester tape 25% overlap
DC Resistance: 6.9 ohms/1000 ft max. at 20° C
Capacitance: 12pF/ft
Color Code: White/Blue

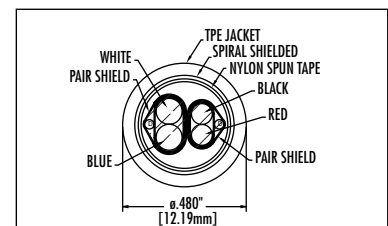

Cable Length	Current	Max. Voltage	Engineering No.	Standard Order No.
50.0m (164.04')	8.0A	300V	DNF00A-M500	130039-0349
100.0m (328.08')			DNF00A-T100	130039-0350

Note: Sales drawings for all standard order numbers are available on molex.com
*DeviceNet is a trademark of Open DeviceNet Vendor Association (ODVA)

DeviceNet* Brad® Bulk Cable

130039 Thick Tray Rated Cable



Features and Benefits

- Designated for tray-rating usage per NEC guidelines or where 600V cable requirements need to be met
- Meets or exceeds ODVA for highest system reliability

Reference Information

UL: Type TC-ER
CSA: 1/II A/B

Overall

Rating: 600V UL type TC
Materials: Power—PVC outer jacket, PP inner insulation,
Data—PVC with nylon skin
Construction: Two shielded pairs, with one 18 AWG
(19x30 AWG) Copper drain wire

Power Pair

Wire: Two 16 AWG (19x29 AWG) individually tinned
Copper
Shielding: Aluminum outside with polyester tape overlap
DC Resistance: 4.9 ohms/1000 ft max. at 20° C
Current: 8.0A
Color Code: Red/Black

Data Pair

Wire: Two 18 AWG (19x30 AWG) individually tinned
Copper
Shielding: Aluminum outside/polyester tape 25% overlap
DC Resistance: 6.9 ohms/1000 ft max. at 20° C
Capacitance: 14.7 pF/ft
Color Code: White/Blue
Velocity of Propagation: 64% NOM
Cable Jacket Color: Gray

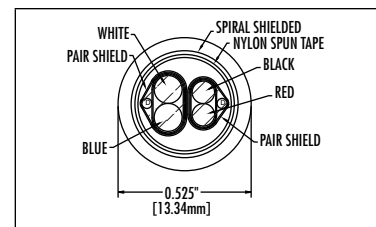

Cable Length	Current	Max. Voltage	Engineering No.	Standard Order No.
50.0m (164.04')	8.0A	600V	DNE00A-M500	130039-0347
100.0m (328.08')			DNE00A-T100	130039-0348

Note: Sales drawings for all standard order numbers are available on molex.com
*DeviceNet is a trademark of Open DeviceNet Vendor Association (ODVA)

DeviceNet* Brad® Bulk Cable

130039 Mid Cable



Features and Benefits

- Meets or exceeds ODVA specifications for thin or drop cable for the highest system reliability
- Allows for cleaner, tighter cable rating of trunk cable for smaller length networks

Reference Information

UL: AWM Style 1569
CSA: AWM I/II A/B 300V FT1, 80° C

Overall

Rating: 300V, 80° C
Materials: Power—Gray PVC outer jacket, PVC inner insulation
Data—PE foam inner insulation
Construction: Two shielded pairs, 20 AWG tinned Copper
drain wire between pair

Power Pair

Wire: Two 16 AWG (65x34 AWG) tinned Copper
Shielding: Aluminum outside/polyester tape 25% overlap
Velocity of Propagation: 75%
DC Resistance: 4.1 ohms/1000 ft max. at 20° C
Current: 8.0A
Color Code: Red/Black

Data Pair

Wire: Two 20 AWG (19x36 AWG) stranded Copper
Shielding: Aluminum outside/polyester tape 25% overlap
DC Resistance: 10.4 ohms/1000 ft max. at 20° C
Capacitance: 12.35pF/ft
Color Code: White/Blue
Cable Jacket Color: Gray

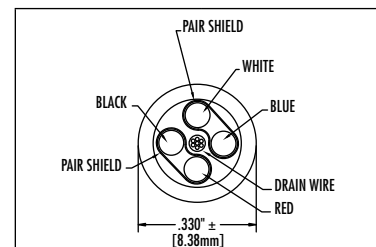

Cable Length	Current	Max. Voltage	Engineering No.	Standard Order No.
50.0m (164.04')	8.0A	300V	DNB00A-M500	130039-0339
100.0m (328.08')			DNB00A-T100	130039-0340

Note: Sales drawings for all standard order numbers are available on molex.com
*DeviceNet is a trademark of Open DeviceNet Vendor Association (ODVA)

DeviceNet* Brad® Bulk Cable

130039 Thin Cable



Features and Benefits

- Meets and exceeds ODVA specifications for the highest reliability
- Standard Thin or drop line cable
- Thin High Flex is rated over 1.4M flexcycles—40% greater than most DeviceNet Flex-rated cabling

Reference Information

UL: CL2, AWM 2464
CSA: FT4 rated

Overall

Rating: 300V 80° C

Materials: Power—PVC outer jacket with semi-rigid PVC inner insulation (power) PE foam inner insulation

Data—PE foam inner insulation

Construction: Two shielded pairs, 22 AWG Tin-Copper drain wire between pairs

Cable Jacket Color: Gray

Power Pair

Wire: Two 22 AWG individually tinned stranded Copper
Shielding: Aluminum foil shield, 25% overlap
DC resistance: 16.5 ohms/1000 ft max. at 20° C
Current: 4.0A
Color Code: Red/Black

Data Pair

Wire: Two 22 AWG individually tinned stranded Copper
Shielding: Aluminum foil shield, 25% overlap
DC resistance: 16.5 ohms/1000 ft max. at 20° C
Velocity of Propagation: 75%
Capacitance: 11pF/ft
Color Code: White/Blue

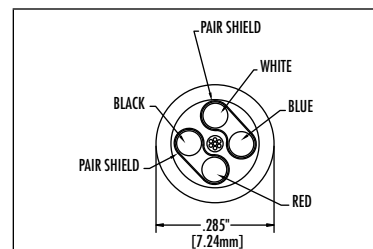

Cable Length	Max. Current	Max. Voltage	Engineering No.	Standard Order No.
100.0m (328.08')	4.0A	300V	DND00A-T100	130039-0381

Note: Sales drawings for all standard order numbers are available on molex.com

*DeviceNet is a trademark of Open DeviceNet Vendor Association (ODVA)

DeviceNet* Brad® Bulk Cable

130039 Thin Flex Rated Cable



Features and Benefits

- Meets and exceeds ODVA specifications for the highest reliability
- Standard Thin or drop line cable
- Thin High Flex is rated over 1.4M flexcycles—40% greater than most DeviceNet Flex-rated cabling

Reference Information

UL: CL3 AWM 20626, flame UL 1581
CSA: AWM 1/II A/B, 80° C, 300V FT1

Overall

Rating: 300V 80° C

Materials: Power—TPE outer jacket PVC with nylon skin skin inner insulation

Data—PE foam inner insulation

Flexure: Rolling flex > 1m cycles at 10x bend radius
Construction: Two foil shielded pairs, 26 AWG Tin-Copper drains between pairs

Cable Jacket Color: Gray

Power pair

Wire: Two 22 AWG individually tinned stranded Copper
Shielding: Aluminum outside/polyester tape, 25% overlap
DC Resistance: 17.5 ohms/1000 ft max. at 20° C
Current: 4.0A
Color Code: Red/Black

Data Pair

Wire: Two 24 AWG individually tinned stranded Copper
Shielding: Aluminum outside/polyester tape, 25% overlap
DC Resistance: 28 ohms/1000 ft max. at 20° C
Velocity of Propagation: 75%
Capacitance: 12pF/ft
Color Code: White/Blue

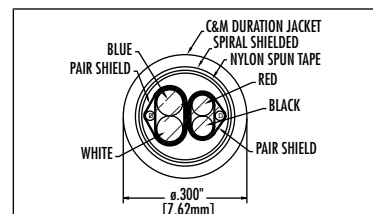

Cable Length	Max. Current	Max. Voltage	Engineering No.	Standard Order No.
100.0m (328.08')	4.0A	300V	DNDF00A-T100	130039-0344

Note: Sales drawings for all standard order numbers are available on molex.com

*DeviceNet is a trademark of Open DeviceNet Vendor Association (ODVA)

DeviceNet* Brad® Bulk Cable

130039 Thin Tray Rated Cable



Features and Benefits

- Designated for tray-rating usage per NEC guidelines or where 300V cable requirements need to be met
- Meets or exceeds ODVA specification for the highest system reliability

Reference Information

UL: CMG, CL2 AWM, flame 1581
CSA : AWM 1/II A, flame FT4

Overall

Rating: 300V UL type CL2 80° C
Materials: Power—PVC outer jacket, PVC with nylon skin inner insulation
Data—FPE insulation
Construction: Two foil shielded pairs with one 22 AWG Copper drain wire between pairs
Cable Jacket Color: Gray

Power pair

Wire: Two 22 AWG individually tinned Copper
Shielding: Aluminum outside with polyester tape overlap
DC Resistance: 17.5% ohms/1000 ft max. at 20° C
Current: 4.0A
Color Code: Red/Black

Data Pair

Wire: Two 24 AWG individually tinned stranded Copper
Shielding: Aluminum outside/polyester tape, 25% overlap
DC Resistance: 28 ohms/1000 ft max. at 20° C
Velocity of Propagation: 75%
Capacitance: 12pF/ft
Color Code: White/Blue

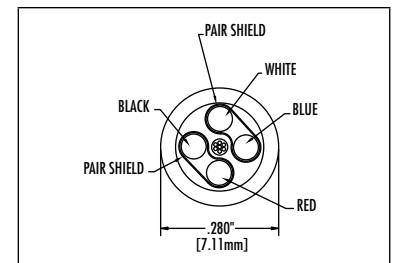

Cable Length	Max. Current	Max. Voltage	Engineering No.	Standard Order No.
100.0m (328.08')	4.0A	300V	DNDG00A-T100	130039-0346

Note: Sales drawings for all standard order numbers are available on molex.com
*DeviceNet is a trademark of Open DeviceNet Vendor Association (ODVA)

DeviceNet* Brad® Mini-Change® Single-Ended Cordsets

130024

**Female
Straight, Right Angle
Threaded
Thick and Mid Media**



Features and Benefits

- Phosphor-Bronze contacts for greatest reliability
- Variety of cable types, cable exit, coupling nut and length options for maximum system flexibility

Reference Information

UL File No.: E152210
CSA File No.: LR6837

Mechanical

Connector Face: PVC-UL STD 94-V
Molded Body: PVC-UL STD 94-V
Coupling Nut: Zinc diecast with black epoxy coat
Optional Stainless Steel or Nickel-plated Brass

Physical

Connector Body: PVC
Contact: Brass with Gold plating
Coupling Nut: Diecast Zinc
Operating Temperature: -20 to +80° C

Environmental

Protection: IP67
NEMA Rating: NEMA 6

Cables

DNB—DeviceNet Mid (Trunk)

Rating: 300V, 80° C
Materials: Power—Gray PVC outer jacket, PVC inner insulation
Data—PE Foam inner insulation
Construction: Two shielded pairs, 20 AWG Tin Copper drain wire between pair

UL: AWM Style 1569
CSA: AWM I/II A/B 300V FY1, 80° C

DN—DeviceNet Thick (Trunk)

Rating: 300V, 80° C
Materials: Power—Gray PVC outer jacket, PVC with Nylon skin inner insulation
Data—PE foam inner insulation
Construction: Two shielded pairs with 18 AWG (19x30 AWG) drain wire between pairs
UL: UL type CL2, VL 1581 flame resistance
CSA: AWM I/II A/B 80° C 300V FT1

DNF—DeviceNet Thick Flex-Rated

Rating: 300V, 80° C
Materials: Power:—TPE outer jacket, PVC with Nylon skin inner insulation
Data—PE Foam inner insulation
Flexure: Rolling flex > 1.4m cycles at 10x bend radius
Construction: Two shielded pairs, 18 AWG (19x30 AWG), drain wire between pair
UL: CL3; AWM 20626, UL 1581
CSA: AWM I/II A/B 80° C 300V FT1

DNE—DeviceNet Thick Tray-Rated

Rating: 600V UL type TC
Materials: Power—PVC outer jacket, PP inner insulation
Data—PVC with Nylon skin
Construction: Two shielded pairs, with one 18 AWG (19x30 AWG), Copper drain wire
UL: Type TC-ER
CSA: I/II A/B

Poles (Female View)	Max. Current per Contact	Max. Voltage	Cable Type	Cable Jacket	Wire Size AWG	Cable Diameter	Cable Length	Straight		Right Angle	
								Engineering No.	Standard Order No.	Engineering No.	Standard Order No.
<p>1 - Drain 4 - CAN_H 2 - V+ 5 - CAN_L 3 - V-</p>	4.0A	300V AC/DC	Mid Cable	PVC	16/20	8.38mm	1.0m	DNB10A-M010	130024-0169	DNB90A-M010	130024-0178
			Thick (Trunk)	PVC	15/18	12.07mm		DN10A-M010	130024-0073	DN90A-M010	130024-0133
	8.0A	600V AC/DC	Thick Flex-Rated	TPE High-Flex	15/18	12.19mm		DNF10A-M010	130024-0337	DNF90A-M010	130024-0341
			Thick Tray-Rated	PVC	16/18	13.34mm		DNE10A-M010	130024-0260		

Note: Sales drawings for all standard order numbers are available on molex.com
*DeviceNet is a trademark of Open DeviceNet Vendor Association (ODVA)

Configuration Code†
Build-a-Part Number

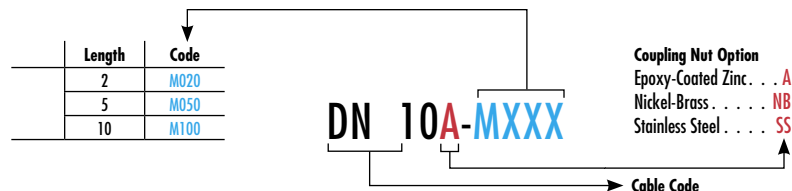

†Once an engineering number is created using the configuration code, consult Molex tech support for information regarding any part numbers.

DeviceNet* Brad® Mini-Change® Single-Ended Cordsets

130024

**Female
Straight, Right Angle
Thin Media
Threaded**



Features and Benefits

- Over-molded open style of DeviceNet connector provides for environmental protection and cable integrity strain relief
- Variety of form factor, cable type and length options available for maximum flexibility

Mechanical

Body: Molded PVC
Insert: PVC

Physical

Contact: Phosphor Bronze
Contact Plating: Gold over Nickel
Operating Temperature: -20 to +80° C

Environmental

Protection: IP67
NEMA Rating: NEMA 6

Cables

DND—Thin Standard

Rating: 300V 80° C
Outer Jacket: PVC
Inner Insulation: Power—Semi-rigid PVC
Data—PE foam
Construction: Two shielded pairs, 22 AWG Tin-Copper drain wire between pairs
Cable Jacket Color: Gray
UL: CL2, AWM 2464
CSA: FT4 Rated

DNDF—Thin High-Flex

Rating: 300V 80° C
Outer Jacket: PVC
Inner Insulation: Power—Semi-rigid PVC
Data—PE foam
Flexure: Rolling Flex > 1 million cycles at 10x bend radius
Construction: Two foil shielded pairs, 26 AWG Tin-Copper drains between pairs
Cable Jacket Color: Gray
UL : CL3 AWM 20626, Flame UL 1581
CSA : AWM: 1/II A/B, 80° C, 300V FT1

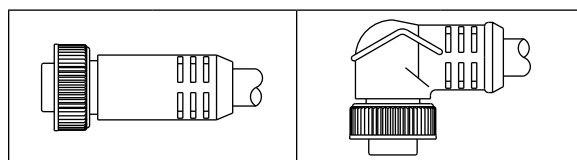

Poles (Female View)	Max. Current per Contact	Max. Voltage	Cable Type	Cable Jacket	Wire Size AWG	Cable Diameter	Length	Straight		Right Angle	
								Engineering No.	Standard Order No.	Engineering No.	Standard Order No.
<p>5 Pole</p> <p>1 - Drain 4 - CAN_H 2 - V+ 5 - CAN_L 3 - V-</p>	4.0A	300V AC/DC	Thin Cable	PVC	22/22	7.24mm	1.0m	DND10A-M010	130024-0215	DND90A-M010	130024-0232
			Thin, High-Flex	TPE	22/24	7.62mm	1.0m	DNDF10A-M010	130024-0353	DNDF90A-M010	130024-0355

Note: Sales drawings for all standard order numbers are available on molex.com
*DeviceNet is a trademark of Open DeviceNet Vendor Association (ODVA)

Configuration Code†
Build-a-Part Number

	Length	Code
Meters	2	M020
	5	M050
	10	M100

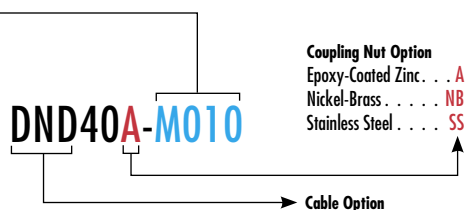

†Once an engineering number is created using the configuration code, consult Molex tech support for information regarding any part numbers.

DeviceNet* Brad® Mini-Change® Single-Ended Cordsets

130024/130025

Male
Straight, Right Angle
Thick and Mid Media
Threaded



Features and Benefits

- Phosphor-Bronze contacts for greatest reliability
- Variety of cable types, cable exit, coupling nut and length options for maximum system flexibility

Reference Information

UL File No.: E152210
CSA File No.: LR6837

Mechanical

Connector Face: PVC-UL Std 94-V
Molded Body: PVC-UL Std 94-V
Coupling Nut: Zinc diecast with black epoxy coat

Physical

Contacts: Phosphor-Bronze base material
Contact Plating: Gold over Nickel per ODVA specs
Operating Temperature: -20 to +80° C

Environmental

Protection: IP67
NEMA Rating: NEMA 6

Cables

DNB—Mid Trunk

Rating: 300V, 80° C
Materials: Power—Gray PVC outer Jacket, PVC inner insulation
Data—PE foam inner insulation
Construction: Two shielded pairs, 20 AWG Tin Copper drain wire between pair
UL: AWM Style 1569
CSA: AWM 1/II A/B 300V FTI, 80° C

Cables (continued)

DN—Thick Trunk

Rating: 300V, 80° C
Materials: Power—Gray PVC outer jacket, PVC with nylon skin inner insulation
Data—PE foam inner insulation
Construction: Two shielded pairs with 18 AWG (19x30 AWG) drain wire between pairs
UL: UL Type CL2, VL 1581 flame resistance
CSA: CSA AWM: 1/II and A/B FT4

DNF—Thick Flex-Rated

Rating: 300V, 80° C
Materials: Power—TPE outer jacket, PVC with nylon skin inner insulation
Data—PE foam inner insulation
Flexure: Rolling Flex >1.4m cycles at 10x bend radius
Construction: Two shielded pairs with 18 AWG (19x30 AWG), drain wire between pairs
UL: CL3; AWM 20626, UL 1581
CSA: AWM 1/II A/B 300V FTI, 80° C

DNE—Thick Tray-Rated

Rating: 600V UL Type TC
Materials: Power—PVC outer jacket, PP inner insulation
Data—PVC with Nylon skin
Construction: Two shielded pairs with one 18 AWG (19x30 AWG) Copper drain wire
UL: Type TC-ER
CSA: 1/II A/B

Poles (Male View)	Max. Current Per Contact	Max. Voltage	Cable Type	Cable Jacket	Cable Diameter	Wire Size AWG	Length	Straight		Right Angle	
								Engineering No.	Standard Order No.	Engineering No.	Standard Order No.
									4.0A	300V AC/DC	Mid Cable
			Thick (Trunk)		12.07mm	15/18	DN01A-M010	130024-0028	DN09A-M010	130024-0059	
			Thick Flex-Rated	TPE High-Flex	12.19mm	15/18	DNF01A-M010	130024-0265			
	8.0A	600V AC/DC	Thick Tray-Rated	PVC	13.34mm	16/18	DNE01A-M010	130024-0249	DNF09A-M010	130025-0538	

Note: Sales drawings for all standard order numbers are available on molex.com
*DeviceNet is a trademark of Open DeviceNet Vendor Association (ODVA)

Configuration Code†
Build-a-Part Number

	Length	Code
Meters	2	M020
	5	M050
	10	M100

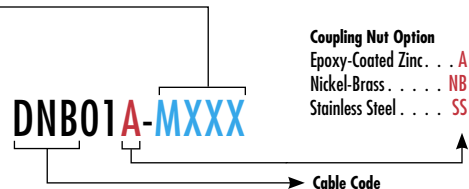

†Once an engineering number is created using the configuration code, consult Molex tech support for information regarding any part numbers.

DeviceNet* Brad® Mini-Change® Single-Ended Cordsets

130024/130027

Male
Straight, Right Angle
Thin Media
Threaded



Features and Benefits

- Phosphor-Bronze contacts for greatest reliability
- Variety of cable types, cable exit, coupling nut and length options for maximum system flexibility

Reference Information

UL File No.: E152210
CSA File No.: LR6837

Mechanical

Connector Face: PVC-UL Std 94-V
Molded Body: PVC-UL Std 94-V
Coupling Nut: Zinc diecast with black epoxy coat

Physical

Contacts: Phosphor-Bronze base material
Contact Plating: Gold over Nickel per ODVA specs
Operating Temperature: -20 to +80° C

Environmental

Protection: IP67
NEMA Rating: NEMA 6

Cables

DND—Thin

Rating: 300V, 80° C
Materials: Power—PVC outer jacket with semi-rigid PVC inner insulation
Data —PE foam inner insulation
Construction: Two shielded pairs, 22 AWG Tin-Copper drain wire between pairs
Cable Jacket Color: Gray

DNDF—Thin High Flex

Rating: 300V, 80° C
Materials: Power—TPE outer jacket, PVC with nylon skin inner insulation
Data —PE foam PE foam inner insulation
Flexure: Rolling Flex >1m cycles at 10x bend radius
Construction: Two foil shielded pairs, 26 AWG Tin-Copper drains between pairs
Cable Jacket Color: Gray

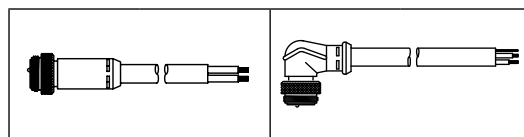

Poles (Male View)	Max. Current Per Contact	Max. Voltage	Cable Type	Cable Jacket	Cable Diameter	Wire Size AWG	Length	Male Straight		Male Right Angle	
								Engineering No.	Standard Order No.	Engineering No.	Standard Order No.
	4.0A	300V AC/DC	Thin	PVC	7.24mm	22/22	1.0m	DND01A-M010	130024-0191	DND09A-M010	130024-0207
			Thin Flex Rated	TPE	7.62mm	22/24		DNDF01A-M010	130024-0005	DNDF09A-M010	130024-0356

Note: Sales drawings for all standard order numbers are available on molex.com
*DeviceNet is a trademark of Open DeviceNet Vendor Association (ODVA)

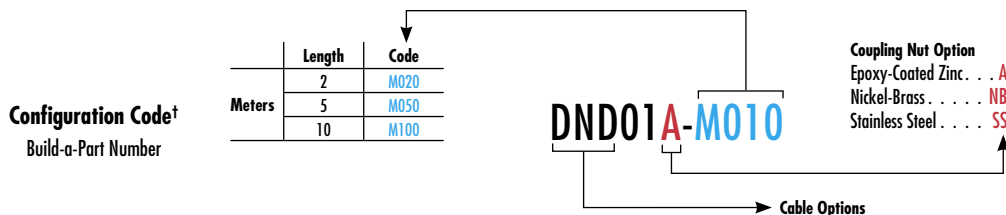

†Once an engineering number is created using the configuration code, consult Molex tech support for information regarding any part numbers.

DeviceNet* Brad® Mini-Change® Double-Ended Cordsets

130025

**Female Straight-to-Male Straight
Right Angle Female-to-Straight
Male
Right Angle Female-to-Right
Angle Male
Thick and Mid Media
Threaded**



Features and Benefits

- Phosphor-Bronze contacts for greatest reliability
- Variety of cable types, cable exit, coupling nut and length options for maximum system flexibility

Reference Information

UL File No.: E152210
CSA File No.: LR6837

Electrical

Voltage: 300V AC/DC
Max. Current per Contact: 4.0A
Thick Tray-Rated: Voltage—300V AC/DC
Thick Tray-Rated: Max. Current per Contact—8.0A

Mechanical

Connector Face: PVC-UL Std 94-V
Molded Body: PVC-UL Std 94-V
Coupling Nut: Zinc diecast with black epoxy coat
Optional stainless Steel or Nickel-coated

Physical

Connector Body: PVC
Cable Jacket: PVC
Cable Jacket Color: Gray
Connector End A: Mini-Change
Connector End B: Mini-Change
Contact: Brass with Gold plating
Copper with Gold over Nickel plating
Coupling Nut: Diecast Zinc
Keyway: Single
LED Indicator: No
Operating Temperature: -20 to +80° C

Environmental

Protection: IP67
NEMA Rating: NEMA 6

Cables

DNB—DeviceNet Mid (Trunk)

Rating: 300V, 80° C
Materials: Power—Gray PVC outer jacket, PVC inner insulation
Data—PE Foam inner insulation
Construction: Two shielded pairs, 20 AWG Tin-Copper drain wire between pair
UL: AWM—Style 1569
CSA: AWM—1/II A/B 300V FY1, 80° C

Cables (continued)

DN—DeviceNet Thick (Trunk)

Rating: 300V, 80° C
Materials: Power—Gray PVC outer jacket, PVC with Nylon skin inner insulation
Data—PE Foam inner insulation
Construction: Two shielded pairs with 18 AWG (19x30 AWG) drain wire between pairs
UL: Type CL2, VL 1581 flame resistance
CSA: AWM I/II A/B 80° C 300V FT1

DNF—DeviceNet Thick Flex-Rated

Rating: 300V, 80° C
Materials: Power—TPE outer jacket, PVC with Nylon skin inner insulation
Data—PE Foam inner insulation
Flexure: Rolling flex > 1.4m cycles at 10x bend radius
Construction: Two shielded pairs, 18 AWG (19x30 AWG), drain wire between pair
UL: CL3; AWM 20626, UL 1581
CSA: AWM I/II A/B 80° C 300V FT1

DNE—DeviceNet Thick Tray-Rated

Rating: 600V UL type TC
Materials: Power—PVC outer jacket, PP inner insulation
Data—PVC with Nylon skin
Construction: Two shielded pairs, with one 18 AWG (19x30 AWG) Copper drain wire
UL: Type TC-ER
CSA: 1/II A/B

Poles (Female View)	Wire/Cable Type	Cable Jacket	Wire Size AWG	Cable Diameter	Cable Length	Female Straight-to-Male Straight		Right Angle Female-to-Straight Male		Right Angle Female-to-Right Angle Male	
						Engineering No.	Standard Order No.	Engineering No.	Standard Order No.	Engineering No.	Standard Order No.
	Mid Cable	PVC	16/20	8.38mm	1.0m	DNB11A-M010	130025-0233				
	Thick (Trunk)	PVC	15/18	12.10mm	1.0m	DN11A-M010	130025-0054	DNB91A-M010	130025-0259	DNB99A-M010	130025-0267
	Thick Flex-Rated	TPE, High-Flex	15/18	12.07mm	1.0m	DNF11A-M010	130025-0408	DNF91A-M010	130025-0173	DNF99A-M010	130025-0197
	Thick Tray-Rated	PVC	16/18	13.34mm	1.0m	DNE11A-M010	130025-0352			DNF99A-M010	130025-0482

Note: Sales drawings for all standard order numbers are available on molex.com
*DeviceNet is a trademark of Open DeviceNet Vendor Association (ODVA)

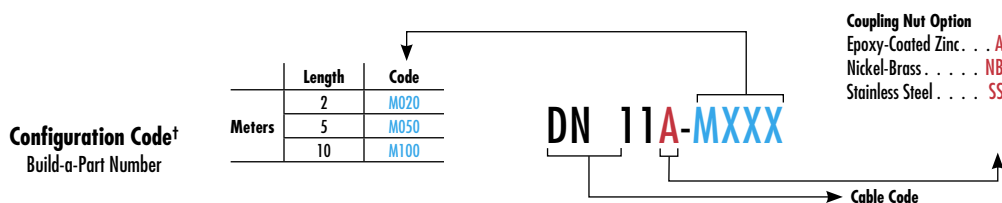

†Once an engineering number is created using the configuration code, consult Molex tech support for information regarding any part numbers.

DeviceNet* Brad® Mini-Change® Double-Ended Cordsets

130025

**Female, Male
Straight, Right Angle
Thin Media
Threaded**



Features and Benefits

- Phosphor-bronze contacts for greatest reliability
- Variety of cable types, cable exit, coupling nut and length options for maximum system flexibility

Reference Information

UL File No.: E152210
CSA File No.: LR6837

Mechanical

Connector Face: PVC-UL Std 94-V
Molded Body: PVC-UL Std 94-V
Coupling Nut: Zinc diecast with black epoxy coat

Physical

Contacts: Phosphor-Bronze base material
Contact Plating: Gold over Nickel per ODVA Specs
Operating Temperature: -20 to +80° C

Environmental

Protection: IP67
NEMA Rating: NEMA 6

Cables

DND—DeviceNet Thin

Rating: 300V 80° C

Materials: Power—PVC outer jacket with semi-rigid PVC inner insulation
Data—PE foam inner insulation

Construction: Two shielded pairs, 22 AWG Tin-Copper drain wire between pairs
Cable Jacket Color: Gray

DNDF—DeviceNet Thin High-Flex

Rating: 300V 80° C

Materials: Power—TPE outer jacket, PVC with nylon skin inner insulation
Data—PE foam inner insulation

Flexure: Rolling Flex > 1m cycles at 10x bend radius
Construction: Two foil shielded pairs, 26 AWG Tin-Copper drains between pairs
Cable Jacket Color: Gray

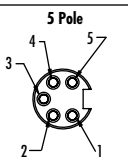
Poles (Female View)	Max. Current per Contact	Max. Voltage	Cable Type	Cable Jacket (Cable Code)	Cable Diameter	Wire Size AWG	Length	Female Straight-to-Male Straight		Female Straight-to-Male Right Angle	
								Engineering No.	Standard Order No.	Engineering No.	Standard Order No.
 <p>5 Pole 1 - Drain 4 - CAH_H 2 - V+ 5 - CAH_L 3 - V-</p>	4.0A	300V AC/DC	Thin	PVC	7.24mm	22/22	1.0m	DND11A-M010	130025-0287	DND19A-M010	130025-0313
			Thin/ Flex Rated	TPE	7.62mm	22/24		DNDF11A-M010	130025-0502	DNDF19A-M010	130025-0013

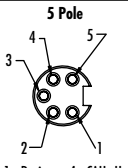
Poles (Female View)	Max. Current per Contact	Max. Voltage	Cable Type	Cable Jacket (Cable Code)	Cable Diameter	Wire Size AWG	Length	Female Right Angle-to-Male Straight		Female Right Angle-to-Male Right Angle	
								Engineering No.	Standard Order No.	Engineering No.	Standard Order No.
 <p>5 Pole 1 - Drain 4 - CAH_H 2 - V+ 5 - CAH_L 3 - V-</p>	4.0A	300V AC/DC	Thin	PVC	7.24mm	22/22	1.0m	DND91A-M010	130025-0322	DND99A-M010	130025-0543
			Thin/Flex-Rated	TPE	7.62mm	22/24		DNDF91A-M010	130025-0546	DNDF99A-M010	130025-0513

Note: Sales drawings for all standard order numbers are available on molex.com

*DeviceNet is a trademark of Open DeviceNet Vendor Association (ODVA)

Configuration Code†
Build-a-Part Number

	Length	Code
Meters	2	M020
	5	M050
	10	M100

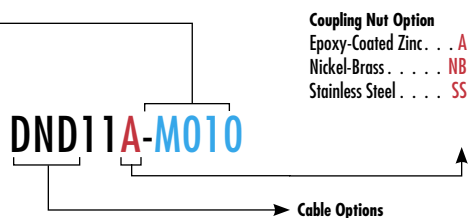

†Once an engineering number is created using the configuration code, consult Molex tech support for information regarding any part numbers.

DeviceNet* Brad® Mini-Change® Back Panel Mount Double-Ended Cordsets

130039

Male-to-Female Straight
Female Straight-to-Male Right Angle
Male-to-Female Straight
Female Right Angle-to-Male Straight
Back Panel Mount
Thick Media



Features and Benefits

- Back panel mount receptacles are used to bring connectivity from inside to outside the control panel
- A variety of configurations are available for maximum flexibility

Reference Information

UL File No.: E152210
CSA File No.: LR6837

Electrical

Voltage Rating: 300V AC/DC
Current: 4.0A

Mechanical

Connector Face: PVC-UL STD 94-V
Molded Body: PVC-UL STD 94-V
Coupling Nut: Zinc diecast with black epoxy coating
Shell: Nickel-Brass
Shell Inserts: PVC-UL STD 94-V

Physical

Contacts: Phosphor-Bronze base material
Contact Plating: Gold over Nickel per ODVA specifications
Operating Temperature: -20 to +80° C

Environmental

Protection: IP67
NEMA Rating: NEMA 6

Cables

DN—Thick Trunk

Rating: 300V, 80° C

Materials: Power—Gray PVC outer jacket, PVC with Nylon skin inner insulation

Data—PE foam inner insulation

Construction: Two shielded pairs with 18 AWG (19x30) drain wire between pairs

UL: Type CL2, VL 1581 flame resistance

CSA: AWM I/II and A/B FT4

Back Panel Face View (Female)	Male-to-Female Straight		Female Straight-to-Male Right Angle		Male-to-Female Straight		Female Right Angle-to-Male Straight	
	Engineering No.	Standard Order No.	Engineering No.	Standard Order No.	Engineering No.	Standard Order No.	Engineering No.	Standard Order No.
<p>5 Pole</p> <p>1 - Drain 4 - CAH_H 2 - V+ 5 - CAH_L 3 - V-</p>	DN5210A-M010	130039-0096	DN5290A-M010	130039-0098	DN5301A-M010	130039-0101	DN5309A-M010	130039-0103

Note: Sales drawings for all standard order numbers are available on molex.com
*DeviceNet is a trademark of Open DeviceNet Vendor Association (ODVA)

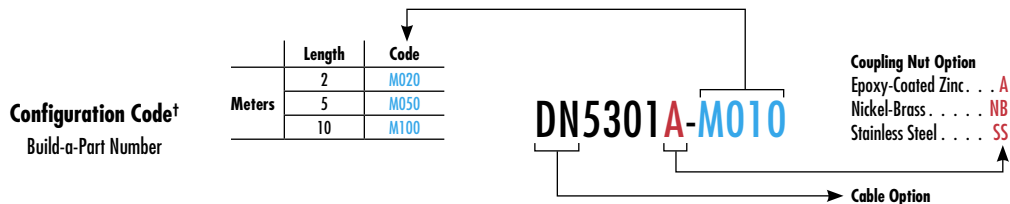

†Once an engineering number is created using the configuration code, consult Molex tech support for information regarding any part numbers.

DeviceNet* Brad® Mini-Change® Trunk Receptacles

130039

Female, Male
Straight
Thick and Mid Media



Features and Benefits

- Receptacles offered with a variety of cable and length options for maximum flexibility
- Receptacles allow for the trunk line to come into an enclosure and make connection to inside of the panel components
- Male or female receptacles are mounted to the enclosure and the back end trunk cabling can be wired to the open terminal strip of a motor controller, the master scanner or a power supply for the network

Reference Information

UL File No.: E152210
CSA File No.: LR6837

Physical

Shell (Receptacle): Gray anodized Aluminum
Insert: PVC—UL STD 94V
Operating Temperature: -20 to +80° C

Environmental

Protection: IP67
NEMA Rating: NEMA 6

Cables

DNB—DeviceNet Mid Trunk

Rating: 300V, 80° C

Materials: Power—Gray PVC outer jacket, PVC inner insulation
Data—PE foam inner insulation

Construction: Two shielded pairs, 20 AWG Tin-Copper drain wire between pairs

UL: AWM Style 1569

CSA: AWM 1/II A/B 300V FTI, 80° C

Outside Diameter: 0.34" (8.60mm)

DN—DeviceNet Thick Trunk

Rating: 300V, 80° C

Materials: Power—Gray PVC outer jacket, PVC with Nylon skin inner insulation
Data—PE foam inner insulation

Construction: Two shielded pairs with 18 AWG (19x30 AWG) drain wire between pairs

UL: Type CL2, VL 1581 flame resistance

CSA: AWM 1/II and A/B 300V FT4

Outside Diameter: 0.48" (12.10mm)

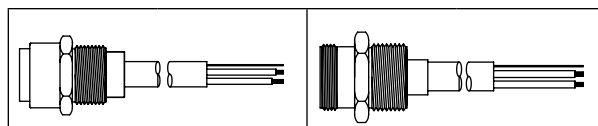

Face View (5 Pole)	Max. Current per Contact	Max. Voltage	Cable Type	Cable Jacket	Wire Size AWG	Length	Configuration			
							Female Straight with 1/2"-14 NPT, Front Panel Mount		Male Straight with 1/2"-14 NPT, Front Panel Mount	
							Engineering No.	Standard Order No.	Engineering No.	Standard Order No.
Female View 1 - Drain 4 - White 2 - Red 5 - Blue 3 - Black	4.0A	300V AC/DC	Trunk (DN)	PVC	15/18	1.0m	DN5000-M010	130039-0284	DN5100-M010	130039-0299
Male View 1 - Drain 4 - White 2 - Red 5 - Blue 3 - Black	4.0A	300V AC/DC	Mid (DNB)	PVC	16/20	1.0m	DNB5000-M010	130039-0312	DNB5100-M010	130039-0318

Note: Sales drawings for all standard order numbers are available on molex.com

*DeviceNet is a trademark of Open DeviceNet Vendor Association (ODVA)

Configuration Code†
Build-a-Part Number

	Length	Code
Meters	2	M020
	5	M050
	10	M100

DNB5000-M010

→ Cable Option

†Once an engineering number is created using the configuration code, consult Molex tech support for information regarding any part numbers.

DeviceNet* Brad® Mini-Change® PCB Mount Receptacles

130188

**Female, Male
Straight
Thick Media
Threaded, PCB Pins**



Features and Benefits

- Receptacles offered with PCB mount options for maximum flexibility

Reference Information

UL File No.: E152210

CSA File No.: LR6837

Physical

Shell: Gray anodized Aluminum

Insert: PVC—UL STD 94V

Operating Temperature: -20 to +80° C

Environmental

Protection: IP67

NEMA Rating: NEMA 6

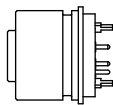
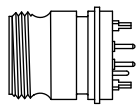
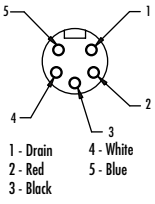
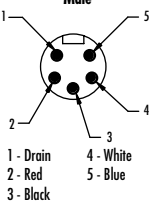
						
		Female Straight with 1/2" - 14 NPT, PCB Mount, PCB Pins		Male Straight with 1/2" - 14 NPT, PCB Mount, PCB Pins		
Poles	Max. Current per Contact	Max. Voltage	Engineering No.	Standard Order No.	Engineering No.	Standard Order No.
5 Pole Female  <p>1 - Drain 4 - White 2 - Red 5 - Blue 3 - Black</p>	8.0A	300V AC/DC	67-0075	130188-0034		
5 Pole Male  <p>1 - Drain 4 - White 2 - Red 5 - Blue 3 - Black</p>	8.0A	300V AC/DC			67-0065	130188-0033

*DeviceNet is a trademark of Open DeviceNet Vendor Association (ODVA)

DeviceNet* Brad® Mini-Change® Bulkhead Feed-Through Receptacles

130013

**Female-Male
Straight
Thick Media**



Features and Benefits

- Receptacles offered with a variety of cable and length options for maximum flexibility
- Bulkhead version features rugged keyways for positive alignment of connections

Reference Information

CSA File No.: LR6837

Physical

Shell: Nickel-plated Brass
Gasket Material: Neoprene
Thrust Washer: Nylon
Locknut Material: Nickel-plated Brass
Insert: PVC—UL STD 94V
Operating Temperature: -20 to +60° C

Environmental

Protection: IP67
NEMA Rating: NEMA 6

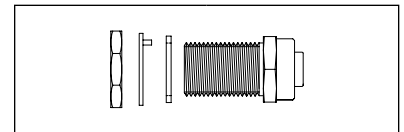

Face View (Female)	Max. Current per Contact	Max. Voltage	Mounting	Engineering No.	Standard Order No.
<p>5 Pole</p> <p>1 - Drain 4 - White 2 - Red 5 - Blue 3 - Black</p>	8.0A	600V	Front Panel Mount	1R5030	130013-0541

*DeviceNet is a trademark of Open DeviceNet Vendor Association (ODVA)

DeviceNet* Brad® Mini-Change® Field Attachable Connectors

130034

**Female, Male
Straight
Thick and Mid Media
Threaded**



Features and Benefits

- Color-coded screw terminators make for error-free field installation
- Accepts a wide range of DeviceNet cables for maximum installation flexibility

Reference Information

CSA File No: LR6837

Physical

Connector Face: Polyurethane
 Connector Body: Polyamide
 Contact: Gold-plated Brass
 Coupling Nut: Nickel-plated Brass
 Grommet: Neoprene
 Cable Range OD: 0.20 to 0.48" (5.00 to 12.00 mm)
 Acceptable Wire Gauges:
 24 AWG (0.25 mm²) to 15 AWG (2.0 mm²)
 Color Coding: Per ODVA standards
 Operating Temperature: -20 to +80° C

Environmental

Protection: IP67

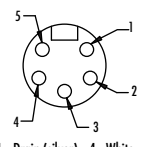
Poles (Female View)	Max. Current per Contact	Max. Voltage	Cable Diameter Range	Male		Female	
				Engineering No.	Standard Order No.	Engineering No.	Standard Order No.
5 Pole  1 - Drain (silver) 4 - White 2 - Red 5 - Blue 3 - Black	8.0A	600V AC/DC	0.20 to 0.48" (5.00 to 12.00mm) OD (Thick and Mid Cables)	1A5006-34DN	130034-0006	1A5000-34DN	130034-0005

Note: Sales drawings for all standard order numbers are available on molex.com
 *DeviceNet is a trademark of Open DeviceNet Vendor Association (ODVA)

DeviceNet* Brad® Mini-Change® Terminator Resistors

130039

**Female, Male
Straight
Threaded
Thick Media**



Features and Benefits

- Phosphor Bronze contacts for maximum reliability
- Diagnostic versions indicate correct polarity at a glance to ensure power connections have been made and made properly

Physical

Connector Face: PVC
 Molded Body: Diagnostic—clear PVC
 STD—gray PVC
 Coupling Nut: Zinc diecast, black e-coat optional
 302 stainless
 Contact Material: Phosphor Bronze alloy
 Contact Plating: Gold over Copper alloy
 LED: Green—Proper polarity
 Red—Improper polarity
 Operating Temperature: 0 to 60° C

Environmental

Protection: IP67
 NEMA Rating: NEMA 6

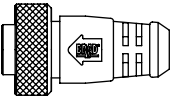
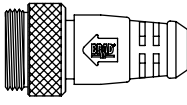
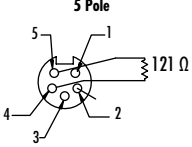
					 Female		 Male	
Poles (Female View)	Max. Current per Contact	Max. Voltage	Connector Face	Type	Engineering No.	Standard Order No.	Engineering No.	Standard Order No.
5 Pole  1 - No connection 4 - Resistor 2 - No connection 5 - Resistor 3 - No connection	8.0A	50V AC/DC	PVC	LED Diagnostic - Clear	DN150L	130039-0072	DN100L	130039-0371
				Molded Gray	DN150	130039-0376	DN100	130039-0370

*DeviceNet is a trademark of Open DeviceNet Vendor Association (ODVA)

DeviceNet* Brad® Mini-Change® Diagnostic Power Monitor® Tees

130035
Male/Female
Thick Media



Features and Benefits

- Minimizes maintenance repair and downtime by analyzing bus power quality
- Predicts power faults by logging outside of specification power conditions thereby increasing uptime
- Helps quickly certify new installations

Reference Information

UL File No.: E152210
CSA File No.: LR6837

Electrical

Power Supply: 7–30V DC, < 50mA
Basic Analog Accuracy: ± 100mV
Minimum “Low” Voltage Threshold: <12.96V
Nominal “OK” Voltage Range: 12.96V–24.78V
Maximum “High” Voltage Threshold: >24.78V
Glitch/Ripple Threshold (AV/AT): Var 75 V/S at 16mS to 640 V/S at 1.0mS
Reset: Magnet at drop “reset” changes mag reed switch state

Physical

Connector Face: Thermo plastic elastomer
Molded Body: Thermo plastic elastomer
Coupling Nut: Zinc diecast black e-coat
Operating Temperature: -20 to +80° C

Environmental

Protection: IP67
NEMA Rating: NEMA 6

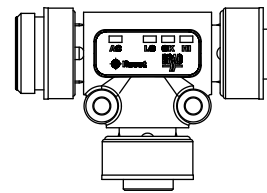

Diagnostic Type	Left Trunk Gender	Right Trunk Gender	Drop Gender	Engineering No.	Standard Order No.
Standard Bus Drop Tee with Diagnostics	Male	Female	Female	DN3020PM-1	130035-0060
	<p>1 - Drain 4 - CAN_H 2 - V+ 5 - CAN_L 3 - V-</p>	<p>1 - Drain 4 - CAH_H 2 - V+ 5 - CAH_L 3 - V-</p>	<p>1 - Drain 4 - CAH_H 2 - V+ 5 - CAH_L 3 - V-</p>		
	Female	Male	Female	DN3020PM-3	130035-0061
	<p>1 - Drain 4 - CAH_H 2 - V+ 5 - CAH_L 3 - V-</p>	<p>1 - Drain 4 - CAN_H 2 - V+ 5 - CAN_L 3 - V-</p>	<p>1 - Drain 4 - CAH_H 2 - V+ 5 - CAH_L 3 - V-</p>		

*DeviceNet is a trademark of Open DeviceNet Vendor Association (ODVA)

Diagnostic Tee

Indication	Led Display	Condition
OK	Green	Normal
HI	Red	Overvoltage
LO	Blue	Undervoltage
HI	Flashing Red	Surge within last 24 hours
LO	Flashing Blue	Brown out within last 24 hours
AC	Flashing Yellow	Power glitch within last 24 hours

DeviceNet* Brad® Mini-Change® Diagnostic Power Monitor® In-Line Adapters

130035

**Male/Female
Thick Media**



Features and Benefits

- Minimizes maintenance repair and downtime by analyzing bus power quality
- Predicts power faults by logging outside of specification power conditions thereby increasing uptime
- Helps quickly certify new installations

Reference Information

UL File No.: E152210

CSA File No.: LR6837

Electrical

Power Supply: 7–30V DC, < 50mA

Basic Analog Accuracy: ±100mV

Minimum “Low” Voltage Threshold: < 12.96V

Nominal “OK” Voltage Range: 12.96V–24.78V

Maximum “High” Voltage Threshold: > 24.78V

Glitch/Ripple Threshold (AV/AT): Var 75 V/S at 16mS to 640 V/S at 1mS

Reset: Magnet at drop “Reset” changes mag reed switch state

Physical

Connector Face: Thermoplastic elastomer

Molded Body: Thermoplastic elastomer

Coupling Nut: Zinc diecast black e-coat

Operating Temperature: -20 to +80° C

Environmental

Protection: IP67

NEMA Rating: NEMA 6

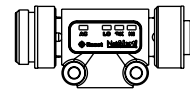

Diagnostic Type	Left Trunk Gender	Right Trunk Gender	Engineering No.	Standard Order No.
Inline Adaptor with Power Diagnostics	Male 1 - Drain 4 - CAH_H 2 - V+ 5 - CAH_L 3 - V-	Female 1 - Drain 4 - CAH_H 2 - V+ 5 - CAH_L 3 - V-	115011A-PM-1	130035-0007
	Female 1 - Drain 4 - CAH_H 2 - V+ 5 - CAH_L 3 - V-	Male 1 - Drain 4 - CAH_H 2 - V+ 5 - CAH_L 3 - V-	115011A-PM-3	130035-0008

Note: Sales drawings for all standard order numbers are available on molex.com

*DeviceNet is a trademark of Open DeviceNet Vendor Association (ODVA)

Diagnostic Tee

Indication	Led Display	Condition
OK	Green	Normal
HI	Red	Overvoltage
LO	Blue	Undervoltage
HI	Flashing Red	Surge within last 24 hours
LO	Flashing Blue	Brown out within last 24 hours
AC	Flashing Yellow	Power glitch within last 24 hours

DeviceNet* Brad® Mini-Change® Tees

130035/130039

Bus Drop Tees
Thick Media



Features and Benefits

- Phosphor bronze contacts for greatest reliability
- Variety of Mini-Change and Micro-Change® configurations for maximum installation flexibility

Reference Information

UL File No.: E152210
CSA File No.: LR6837

Electrical

Voltage Rating: Mini-Change—600V AC/DC
Micro-Change—250V AC/DC
Current: Mini-Change Drop—8.0A
Micro-Change Drop—4.0A

Physical

Connector Face: Brad Micro-Change Drop Tee—PCV
Molded Body: Brad Mini-Change Drop Tee—TPE
Coupling Nut: Zinc diecast black e-coat
Contact Material: Phosphor Bronze alloy
Contact Plating: Gold over Nickel alloy
Operating Temperature: -20 to +80° C

Environmental

Protection: IP67
NEMA Rating: NEMA 6

View	Wiring Schematic	Face View (Left Trunk Female)	Face View (Right Trunk Male)	Face View (Drop Gender Female)	Engineering No.	Standard Order No.
	<p>1 - Drain 2 - V+ 3 - V- 4 - CAN_H 5 - CAN_L</p>	<p>Mini-Change</p> <p>1 - Drain 4 - CAH_H 2 - V+ 5 - CAH_L 3 - V-</p>	<p>Mini-Change</p> <p>1 - Drain 4 - CAN_H 2 - V+ 5 - CAN_L 3 - V-</p>	<p>Mini-Change</p> <p>1 - Drain 4 - CAH_H 2 - V+ 5 - CAH_L 3 - V-</p>	DN3020	130035-0057
		DN3200	130035-0071			
		<p>Mini-Change</p> <p>1 - Drain 4 - CAH_H 2 - V+ 5 - CAH_L 3 - V-</p>	<p>Mini-Change</p> <p>1 - Drain 4 - CAN_H 2 - V+ 5 - CAN_L 3 - V-</p>	<p>Micro-Change</p> <p>1 - Drain 4 - CAN_H 2 - V+ 5 - CAN_L 3 - V-</p>	DND3020	130039-0341

Note: Sales drawings for all standard order numbers are available on molex.com
*DeviceNet is a trademark of Open DeviceNet Vendor Association (ODVA)

DeviceNet* Brad® Mini-Change® Gender Changers

130035/130039

Straight Female-to-Male
Straight Male-to-Female
Right Angle Male-to-Female
Thick Media
Threaded

Features and Benefits

- Phosphor Bronze contacts for greatest reliability
- Variety of male-to-female and female-to-male connection options for maximum installation flexibility

Physical

Connector Face: Thermoplastic elastomer
Molded Body: Thermoplastic elastomer
Coupling Nut: Zinc diecast, black e-coat; Stainless Steel, Nickel-plated Brass optional
Contact Material: Phosphor Bronze alloy
Contact Plating: Gold over Nickel
Operating Temperature: -20 to +80° C

Environmental

Protection: IP67
NEMA Rating: NEMA 6P

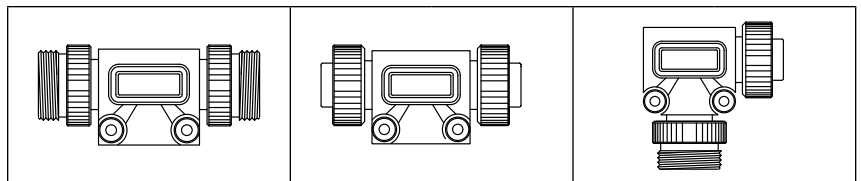

Poles	Max. Current per Contact	Max. Voltage	Female-to-Male		Male-to-Female		Right Angle Male-to-Female Connector	
			Engineering No.	Standard Order No.	Engineering No.	Standard Order No.	Engineering No.	Standard Order No.
5 Pole Female 1 - Drain 4 - CAH_H 2 - V+ 5 - CAH_L 3 - V-	8.0A	600V AC/DC	115060A	130035-0015	115010A	130039-0351	115032A	130035-0013
5 Pole Male 1 - Drain 4 - CAH_H 2 - V+ 5 - CAH_L 3 - V-								

*DeviceNet is a trademark of Open DeviceNet Vendor Association (ODVA)

Configuration Code†
Build-a-Part Number

115060**A**

Coupling Nut Option
 Epoxy-Coated Zinc . . . **A**
 Nickel-Brass **NB**
 Stainless Steel **SS**

†Once an engineering number is created using the configuration code, consult Molex tech support for information regarding any part numbers.

DeviceNet* Brad® Mini-Change® Passive Multi-Ports

130036
Side Mount Bus-In Connection
Thick and Mid Media



Features and Benefits

- A family of configurations from 4- to 8-port for maximum installation flexibility
- Rugged enclosure for reliable connectors in an industrial environment

Reference Information

UL File No.: E46237
CSA File No: LR6837

Electrical

Voltage Rating: 120V AC/DC
Current: 7.0A total per MPIS unit

Mechanical

Insert: PVC
Housing: Pet (Polyester)
Receptacle Housing: Zinc diecast with black epoxy coat
ID Label: ABS

Physical

Operating Temperature: 0 to 60° C

Environmental

Protection: IP67
NEMA Rating: NEMA 6

Face View	Ports	Box Configuration	Wiring Schematic	Engineering No.	Standard Order No.
<p>Female drop</p> <p>1 - Drain 4 - CAH_H 2 - V+ 5 - CAH_L 3 - V-</p>	4			DN4000	130036-0005
<p>Male bus in</p> <p>1 - Drain 4 - CAH_H 2 - V+ 5 - CAH_L 3 - V-</p>	6			DN6000	130036-0008
<p>Male bus in</p> <p>1 - Drain 4 - CAH_H 2 - V+ 5 - CAH_L 3 - V-</p>	8			DN8000	130036-0010

*DeviceNet is a trademark of Open DeviceNet Vendor Association (ODVA)

DeviceNet* Brad® Mini-Change® Passive Multi-Ports

130036

Side Mount
Bus-In-Bus-Out Connection
Thick and Mid Media



Features and Benefits

- Family of configurations for maximum flexibility
- Simple Bus-In/Bus-Out connections for connection convenience
- Rugged housing and connectors designed to withstand tough industrial environments

Reference Information

UL File No.: E46237
CSA File No.: LR6837

Electrical

Voltage Rating: 120V AC/DC
Current: 7.0A total per MPIS unit

Mechanical

Insert: PVC
Housing: PET (Polyester)
Receptacle Shell: Zinc diecast with black epoxy coat
ID Label: ABS

Physical

Operating Temperature: 0 to 60° C

Environmental

Protection: IP67
NEMA Rating: NEMA 6

Face View	Ports	Box Configuration	Wiring Schematic	Engineering No.	Standard Order No.
<p>Female Pass Through</p> <p>1 - Drain 4 - CAH_H 2 - V+ 5 - CAH_L 3 - V-</p>	2			DN2100	130039-0336
<p>Male Bus-In</p> <p>1 - Drain 4 - CAH_H 2 - V+ 5 - CAH_L 3 - V-</p>	4			DN4100	130036-0006
<p>Female Bus-Out</p> <p>1 - Drain 4 - CAH_H 2 - V+ 5 - CAH_L 3 - V-</p>	6			DN6100	130036-0009

*DeviceNet is a trademark of Open DeviceNet Vendor Association (ODVA)

DeviceNet* Brad® Micro-Change® (M12) Single-Ended Cordsets

130027
Female, Pigtail
Straight, Right Angle
Thin Media



Features and Benefits

- Rugged, IP67 rated connectors for continued connection integrity in industrial environments
- Variety of cable types, cable exit, form factor, coupling nut and length options for maximum flexibility

Physical

Body: Molded PVC
Insert: Nylon 6/6
Contacts: Phosphor Bronze
Contact Plating: Gold over Nickel
Operating Temperature: -20 to +80° C

Environmental

Protection: IP67
NEMA Rating: NEMA 6

Cables

DND—Thin Standard

Rating: 300V 80° C
Outer Jacket: PVC
Inner Insulation: Power—Semi-rigid PVC
Data—PE foam
Construction: Two shielded pairs, 22 AWG Tin-Copper drain wire between pairs
Cable Jacket Color: Gray
UL: CL2, AWM 2464
CSA: FT4 Rated

DNDF—Thin High-Flex

Rating: 300V 80° C
Outer Jacket: PVC
Inner Insulation: Power—Semi-rigid PVC
Data—PE foam
Flexure: Rolling Flex > 1 million cycles at 10x bend radius
Construction: Two foil shielded pairs, 26 AWG Tin-Copper drains between pairs
Cable Jacket Color: Gray
UL : CL3 AWM 20626, Flame UL 1581
CSA : AWM 1/II A/B, 80° C, 300V FT1

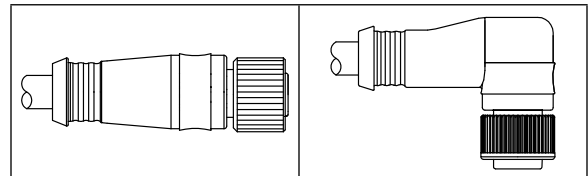

Face View (Female)	Max. Current per Contact	Max. Voltage	Cable Type	Cable Jacket	Wire Size AWG	Cable Diameter	Length	Straight		Right Angle	
								Engineering No.	Standard Order No.	Engineering No.	Standard Order No.
<p>1 - Drain 4 - CAN_H 2 - V+ 5 - CAN_L 3 - V-</p>	4.0A	250V AC	Thin Cable	PVC	22/22	7.24mm	1.0m	DND20A-M010	130027-0048	DND30A-M010	130027-0075
			Thin, High-Flex	TPE	22/24	7.62mm	1.0m	DNDF20A-M010	130027-0171	DNDF30A-M010	130027-0161

Note: Sales drawings for all standard order numbers are available on molex.com
*DeviceNet is a trademark of Open DeviceNet Vendor Association (ODVA)

Configuration Code† Build-a-Part Number

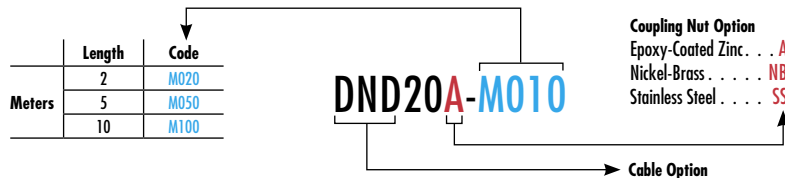

†Once an engineering number is created using the configuration code, consult Molex tech support for information regarding any part numbers.

DeviceNet* Brad® Micro-Change® (M12) Single-Ended Cordsets

130027

Male
Straight, Right Angle
Thin Media
Threaded



Features and Benefits

- Rugged, IP67 rated connectors for continued connection integrity in industrial environments
- Variety of cable type, cable exit, form factor, coupling nut and length options for maximum flexibility

Mechanical

Body: Molded PVC
Insert: PVC

Physical

Contact: Phosphor Bronze
Contact Plating: Gold over Nickel
Operating Temperature: -20 to +80° C

Environmental

Protection: IP67
NEMA Rating: NEMA 6

Cables

DND—Thin Standard

Rating: 300V 80° C
Outer Jacket: PVC
Inner Insulation: Power—Semi-rigid PVC
Data—PE foam
Construction: Two shielded pairs, 22 AWG Tin-Copper drain wire between pairs
Cable Jacket Color: Gray
UL: CL2, AWM 2464
CSA: FT4 Rated

DNDF—Thin High-Flex

Rating: 300V 80° C
Outer Jacket: PVC
Inner Insulation: Power—Semi-rigid PVC
Data—PE foam
Flexure: Rolling Flex > 1 million cycles at 10x bend radius
Construction: Two foil shielded pairs, 26 AWG Tin-Copper drains between pairs
Cable Jacket Color: Gray
UL : CL3 AWM 20626, Flame UL 1581
CSA : AWM I/II A/B, 80° C, 300V FT1

Face View (Male)	Max. Current per Contact	Max. Voltage	Cable Type	Cable Jacket	Cable Diameter	Wire Size AWG	Length	Straight		Right Angle	
								Engineering No.	Standard Order No.	Engineering No.	Standard Order No.
									4.0A	250V AC/DC	Thin
1 - Drain 2 - V+ 3 - V- 4 - CAN_H 5 - CAN_L			Flex Rated	TPE	7.62mm	22/24	1.0m	DNDF02A-M010	130027-0103	DNDF03A-M010	130027-0115

Note: Sales drawings for all standard order numbers are available on molex.com
*DeviceNet is a trademark of Open DeviceNet Vendor Association (ODVA)

Configuration Code†
Build-a-Part Number

	Length	Code
Meters	2	M020
	5	M050
	10	M100

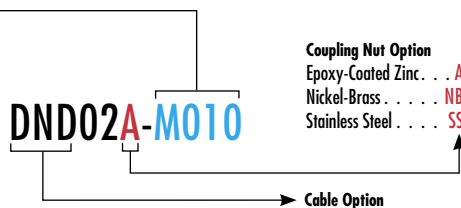

†Once an engineering number is created using the configuration code, consult Molex tech support for information regarding any part numbers.

DeviceNet* Brad® Micro-Change® (M12) Double-Ended Cordsets

130028
Female, Male
Straight, Right Angle
Thin Media
Threaded



Features and Benefits

- Rugged, IP67 rated connectors for continued connection integrity in industrial environments
- Variety of cable, cable exit, form factor, coupling nut and length options for maximum flexibility

Reference Information

UL File No.: E152210
CSA File No.: LR6837

Physical

Connector Face: Nylon 6/6
Molded Body: PVC
Coupling Nut: Zinc diecast with black epoxy coat
Operating Temperature: -20 to +80° C

Environmental

Protection: IP67
NEMA Rating: NEMA 6

Cables

DND—DeviceNet Thin

Rating: 300V, 80° C

Materials: Power—PVC outer jacket with semigrind PVC inner insulation

Data—PE foam inner insulation

Construction: Two shielded pairs, 22 AWG Tin-Copper drain wire between pairs

Cable Jacket Color: Gray

DNDF—DeviceNet Thin High Flex

Rating: 300V, 80° C

Materials: Power—TPE outer jacket PVC with Nylon skin inner insulation

Data—PE foam inner insulation

Flexure: Rolling flex > 1m cycles at 10x bend radius

Construction: Two foil shielded pairs, 26 AWG Tin-Copper drains between pairs

Cable Jacket Color: Gray

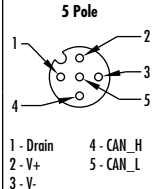
Poles (Female View)	Max. Current per Contact	Max. Voltage	Cable Type	Cable Jacket (Cable Code)	Cable Diameter	Wire Size	Length	Female Straight-to-Male Straight		Female Straight-to-Male Right Angle	
								Engineering No.	Standard Order No.	Engineering No.	Standard Order No.
5 Pole 	4.0A	250V	Thin	PVC	7.24mm (.285")	22/22	1m (3.28')	DND22A-M010	130028-0028	DND23A-M010	130028-0070
			Thin/ Flex Rated	TPE	7.62mm (.300")	22/24		DNDF22A-M010	130028-0132	DNDF23A-M010	130028-0163

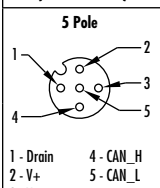
Poles (Female View)	Max. Current per Contact	Max. Voltage	Cable Type	Cable Jacket (Cable Code)	Cable Diameter	Wire Size	Length	Female Right Angle-to-Male Straight		Female Right Angle-to-Male Right Angle	
								Engineering No.	Standard Order No.	Engineering No.	Standard Order No.
5 Pole 	4.0A	250V	Thin	PVC	7.24mm (.285")	22/22	1m (3.28')	DND32A-M010	130028-0085	DND33A-M010	130028-0104
			Thin/ Flex Rated	TPE	7.62mm (.300")	22/24		DNDF32A-M010	130028-0172	DNDF33A-M010	130028-0183

*DeviceNet is a trademark of Open DeviceNet Vendor Association (ODVA)
Note: Sales drawings for all standard order numbers are available on molex.com

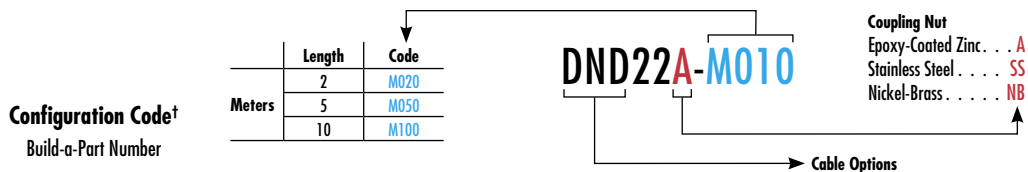

†Once an engineering number is created using the configuration code, consult Molex tech support for information regarding any part numbers.

DeviceNet* Brad® Micro-Change (M12)- to-Mini-Change Double-Ended Cordsets

130039

Female, Male
Straight, Right Angle
Thin Media
Threaded



Features and Benefits

- Rugged, IP67 rated connectors for continued connection integrity in industrial environments
- Variety of cable, cable exit, form factor, coupling nut and length options for maximum flexibility

Reference Information

UL File No.: E152210
CSA File No.: LR6837

Physical

Connector Face: Brad Micro-Change—Nylon 6/6
Brad Mini-Change—PVC

Molded Body: PVC

Coupling Nut: Zinc diecast with black epoxy coat

Operating Temperature: -20 to +80° C

Environmental

Protection: IP67
NEMA Rating: NEMA 6

Cables

DND—DeviceNet Thin

Rating: 300V 80° C

Materials: Power—PVC outer jacket with semigrad PVC inner insulation

Data—PE foam inner insulation

Construction: Two shielded pairs, 22 AWG Tin-Copper drain wire between pairs

Cable Jacket Color: Gray

DNDF—DeviceNet Thin High-Flex

Rating: 300V 80° C

Materials: Power—TPE outer jacket, PVC with nylon skin inner insulation

Data—PE foam inner insulation

Flexure: Rolling Flex > 1m cycles at 10x bend radius

Construction: Two foil shielded pairs, 26 AWG Tin-Copper drain wire between pairs

Cable Jacket Color: Gray

Face View (Female)	Max. Current per Contact	Max. Voltage	Cable Type	Cable Jacket (Cable Code)	Cable Diameter	Wire Size	Length	Micro Female Straight-to-Mini Male Straight		Micro Female Straight-to-Mini Male Right Angle	
								Engineering No.	Standard Order No.	Engineering No.	Standard Order No.
<p>1 - Drain 4 - CAH_H 2 - V+ 5 - CAH_L 3 - V-</p>	4.0A	250V	Thin	PVC	7.24mm	22/22	1.0m	DND21A-M010	130039-0157	DND29A-M010	130039-0175
			Thin/Flex-Rated	TPE	7.62mm	22/24		DNDF21A-M010	130039-0248	DNDF29A-M010	130039-0257

Face View (Female)	Max. Current per Contact	Max. Voltage	Cable Type	Cable Jacket (Cable Code)	Cable Diameter	Wire Size	Length	Micro Female Right Angle-to-Mini Male Straight		Micro Female Right Angle-to-Mini Male Right Angle	
								Engineering No.	Standard Order No.	Engineering No.	Standard Order No.
<p>1 - Drain 4 - CAH_H 2 - V+ 5 - CAH_L 3 - V-</p>	4.0A	250V	Thin	PVC	7.24mm	22/22	1.0m	DND31A-M010	130039-0179	DND39A-M010	130039-0188
			Thin/Flex-Rated	TPE	7.62mm	22/24		DNDF31A-M010	130039-0259	DNDF39A-M010	130039-0263

*DeviceNet is a trademark of Open DeviceNet Vendor Association (ODVA)
Note: Sales drawings for all standard order numbers are available on molex.com

Configuration Code†
Build-a-Part Number

	Length	Code
Meters	2	M020
	5	M050
	10	M100

Cable Options

DND12A-M010

Coupling Nut
Epoxy-Coated Zinc . . . A
Stainless Steel SS
Nickel-Bronze NB

†Once an engineering number is created using the configuration code, consult Molex tech support for information regarding any part numbers.

DeviceNet* Brad® Mini-Change®-to- Micro-Change® (M12) Double-Ended Cordsets

130039

**Female, Male
Straight, Right Angle
Thin Media
Threaded**



Features and Benefits

- Rugged, IP67 rated connectors for continued connection integrity in industrial environments
- Variety of cable, cable exit, form factor, coupling nut and length options for maximum flexibility

Reference Information

UL File No.: E152210
CSA File No.: LR6837

Physical

Connector Face: Brad Micro-Change—Nylon 6/6
Brad Mini-Change—PVC
Molded Body: PVC
Coupling Nut: Zinc diecast with black epoxy coat
Operating Temperature: -20 to +80° C

Environmental

Protection: IP67
NEMA Rating: NEMA 6

Cables

DND—DeviceNet Thin

Rating: 300V, 80° C

Materials: Power—PVC outer jacket with semigrad PVC inner insulation

Data—PE foam inner insulation

Construction: Two shielded pairs, 22 AWG Tin-Copper drain wire between pairs

Cable Jacket Color: Gray

DNDF—DeviceNet Thin High Flex

Rating: 300V, 80° C

Materials: Power—TPE outer jacket PVC with Nylon skin inner insulation

Data—PE foam inner insulation

Flexure: Rolling flex > 1m cycles at 10x bend radius

Construction: Two foil shielded pairs, 26 AWG Tin-Copper drains between pairs

Cable Jacket Color: Gray

Poles (Female View)	Max. Current per Contact	Max. Voltage	Cable Type	Cable Jacket (Cable Code)	Cable Diameter	Wire Size	Length	Female Straight-to-Male Straight		Female Straight-to-Male Right Angle		
								Engineering No.	Standard Order No.	Engineering No.	Standard Order No.	
								<p>1 - Drain 4 - CAH_H 2 - V+ 5 - CAH_L 3 - V-</p>				Thin
Thin/ Flex Rated	TPE	7.62mm	22/24	DNDF12A-M010	130039-0523	DNDF13A-M010	130039-0245					

Poles (Female View)	Max. Current per Contact	Max. Voltage	Cable Type	Cable Jacket (Cable Code)	Cable Diameter	Wire Size	Length	Female Right Angle-to-Male Straight		Female Right Angle-to-Male Right Angle		
								Engineering No.	Standard Order No.	Engineering No.	Standard Order No.	
								<p>1 - Drain 4 - CAH_H 2 - V+ 5 - CAH_L 3 - V-</p>				Thin
Thin/ Flex Rated	TPE	7.62mm	22/24	DNDF92A-M010	130039-0266	DNDF93A-M010	130039-0551					

Note: Sales drawings for all standard order numbers are available on molex.com
*DeviceNet is a trademark of Open DeviceNet Vendor Association (ODVA)

Configuration Code†
Build-a-Part Number

	Length	Code
Meters	2	M020
	5	M050
	10	M100

DND12A-M010

Cable Options ←

Coupling Nut
Epoxy-Coated Zinc . . . A
Stainless Steel . . . SS
Nickel-Brass . . . NB

†Once an engineering number is created using the configuration code, consult Molex tech support for information regarding any part numbers.

DeviceNet* Brad® Micro-Change® Double-Ended Cordsets

130031/130039

Straight, Right Angle,
Female, Male
Thin Media
Panel Mount
Threaded



Features and Benefits

- Back panel mount receptacles are used to couple connectivity from the inside to the outside of the control panel
- A variety of configurations are available for maximum flexibility

Reference Information

UL File No.: E152210
CSA File No.: LR6837

Physical

Connector Face: Nylon 6/6
Molded Body: PVC
Coupling Nut: Zinc diecast with black epoxy coating
Optional Stainless Steel or Nickel-Brass
Shell: Nickel-Brass
Shell Insert: Nylon 6/6
Contacts: Phosphor Bronze alloy
Contact Plating: Gold over Nickel per ODVA specifications
Operating Temperature: -20 to +80° C

Environmental

Protection: IP67
NEMA Rating: NEMA 6

Cables

DND—DeviceNet Thin

Rating: 300V 80° C

Materials: Power—PVC outer jacket with semi-rigid PVC insulation

Data—PE foam inner insulation

Construction: Two shielded pairs, 20 AWG Tin Copper drain wire between pairs

Cable Jacket Color: Gray

Poles (Female View)	Max. Current per Voltage	Maximum Voltage	Cable Type	Cable Jacket	Cable Diameter	Wire Size AWG	Length	Straight-to-Back Panel Mount		Right Angle-to-Back Panel Mount		Back Panel Mount-to-Straight		Back Panel Mount-to-Right Angle	
								Engineering No.	Standard Order No.	Engineering No.	Standard Order No.	Engineering No.	Standard Order No.	Engineering No.	Standard Order No.
<p>1 - Drain 4 - CAH_H 2 - V+ 5 - CAH_L 3 - V-</p>	4.0A	250V	Thin	PVC	7.24mm	22/22	0.5m	DNDC302A-M005	130039-0230	DNDC303A-M005	130031-0012	DNDC220A-M005	130039-0223	DNDC230A-M010	130031-0014

Note: Sales drawings for all standard order numbers are available on molex.com

*DeviceNet is a trademark of Open DeviceNet Vendor Association (ODVA)

Configuration Code†
Build-a-Part Number

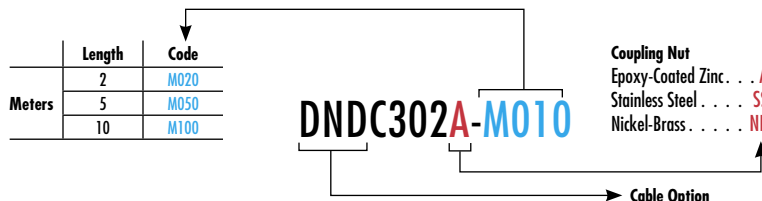

†Once an engineering number is created using the configuration code, consult Molex tech support for information regarding any part numbers.

DeviceNet* Brad® Micro-Change® (M12) Single-Ended Panel Mount Receptacles

130031
Female, Male
Straight
Thin Media



Features and Benefits

- A variety of options allows for maximum flexibility in connecting device nodes
- DeviceNet color coded wiring coming from the back of the receptacle
- The length of wiring can be varied

Physical

Shell: Anodized Aluminum
Insert: Nylon 6/6
Panel Nut: Steel, Zinc plated
Contact Pin: Copper alloy, Gold over Nickel plating
O-Ring: Nitrile
Operating Temperature: -20 to +80° C

Environmental

Protection: IP67
NEMA Rating: NEMA 6P

Face View	Max. Current per Contact	Max. Voltage	Configuration		Configuration	
			Engineering No.	Standard Order No.	Engineering No.	Standard Order No.
<p>Female</p> <p>1 - Drain 4 - CAN_H 2 - V+ 5 - CAN_L 3 - V-</p>	4.0A	250V AC/DC	Female Straight, Front Panel Mount with 1/4"-18 NPT Mounting Thread	Male Straight, Front Panel Mount with 1/4"-18 NPT Mounting Thread		
<p>Male</p> <p>1 - Drain 4 - CAN_H 2 - V+ 5 - CAN_L 3 - V-</p>			4.0A	250V AC/DC	Wire Type PVC, UL 1061	Wire Type PVC, UL 1061
					Wire Size AWG 22	Wire Size AWG 22
			Length 12.00"	Length 12.00"		

Note: Sales drawings for all standard order numbers are available on molex.com
*DeviceNet is a trademark of Open DeviceNet Vendor Association (ODVA)

DeviceNet* Brad® Micro-Change® (M12) Bulkhead Feed-Through

120070

Female Straight-to-Male Straight
Thin Media

Features and Benefits

- Bulkhead version features keyways for positive alignment of connections

Physical

Shell: Nickel over Brass
Insert: Nylon 6/6
Gasket Material: Neoprene
Lock Washer: Steel alloy
Operating Temperature: -20 to +80° C

Environmental

Protection: IP67
NEMA Rating: NEMA 6

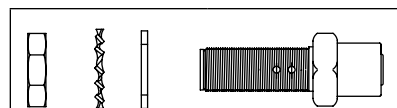

Poles	Max. Current per Contact	Max. Voltage	Mounting Style	Female Straight-to-Male Straight	
				Engineering No.	Standard Order No.
<p>5 Pole Female</p> <p>1 - Drain 4 - CAH_H 2 - V+ 5 - CAH_L 3 - V-</p> <p>5 Pole Male</p> <p>1 - Drain 4 - CAN_H 2 - V+ 5 - CAN_L 3 - V-</p>	4.0A	250V AC/DC	Front Panel Mount	8R5L30	120070-0237

Note: Sales drawings for all standard order numbers are available on molex.com
*DeviceNet is a trademark of Open DeviceNet Vendor Association (ODVA)

DeviceNet* Brad® Micro-Change® (M12) Field Attachable Connectors

130034
Female, Male
Straight
Thin Media
Threaded



Features and Benefits

- Color-coded screw terminals make for error-free field installation
- Rugged housing material designed to withstand industrial environments

Reference Information

CSA File No.: LR6835

Physical

Connector Face: Polyamide
Molded Body: Polyamide
Contact: Silver-plated Brass
Coupling Nut: Nickel-plated Brass
Grommet: Nitrite Rubber
Cable Range OD: 0.16 to 32.00" OD (4.10 to 8.10 mm)
Acceptable Cable Types: Thin, Thin-Flex, Thin-600V
Color Coding: Per DeviceNet standards
Operating Temperature: -25 to +90° C

Environmental

Protection: IP67
NEMA Rating: NEMA 6

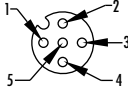
Poles (Female View)	Max. Current per Contact	Max. Voltage	Cable Diameter Range	Male		Female	
				Engineering No.	Standard Order No.	Engineering No.	Standard Order No.
5 Pole  1 - Silver (drain) 4 - White 2 - Red 5 - Blue 3 - Black	4.0A	30V AC 36V DC	0.16 to 0.32" OD Cable (Thin) (4.06 to 8.13mm)	8A5006-32DN	130034-0008		
						8A5000-32DN	130034-0007

*DeviceNet is a trademark of Open DeviceNet Vendor Association (ODVA)
Note: Sales drawings for all standard order numbers are available on molex.com

DeviceNet*
Brad® Micro-Change®
(M12)
Terminators
120039/130039
Female, Male
Straight
Thin Media
Threaded

Features and Benefits

- Phosphor Bronze contacts for maximum reliability
- Diagnostic versions indicate correct polarity at a glance to ensure power connections have been made and made properly

Physical

Connector Face: Nylon
 Molded Body: Diagnostic—Clear PVC
 STD—Gray PVC
 Coupling Nut: Zinc diecast, black e-coat
 Contact Material: Phosphor Bronze alloy
 Contact Plating: Gold over Copper alloy
 LED: Green—Proper polarity
 Red—Improper polarity
 Operating Temperature: 0 to 60° C

Environmental

Protection: IP67
 NEMA Rating: NEMA 6



Poles (Female View)	Max. Current per Contact	Max. Voltage	Connector Face	Type	Female		Male	
					Engineering No.	Standard Order No.	Engineering No.	Standard Order No.
<p>5 Pole</p> <p>1 - No connection 4 - Resistor 2 - No connection 5 - Resistor 3 - No connection</p>	4.0A	30V	Nylon	LED Diagnostic-Clear	DND150L	120039-0003	DND100L	120039-0001
				Molded Gray	DND150	130039-0385	DND100	130039-0382
				Molded Gray-Jumpered*	DND151	130039-0386	DND101	130039-0125

*Jumpered terminators are used during network installation for continuity verification
 DeviceNet is a trademark of Open DeviceNet Vender Association (ODVA)

DeviceNet* Brad® Micro-Change® (M12) Tees and Splitters

130035/130039

Bus Drop
Thin Media



Features and Benefits

- Phosphor Bronze contacts for greatest reliability
- Tees enable tapping into trunk line to add drop lines or devices
- Splitters allow service to two devices through just one connection

Tee

Electrical

Voltage: 250V AC/DC
Current: Drop—4.0A
Contact Material: Phosphor Bronze Alloy
Contact Plating: Gold over Nickel Alloy

Physical

Connector Face: Drop Tee—PVC
Molded Body: Drop Tee—PVC
Coupling Nut: Nickel-plated Brass
Operating Temperature: -20 to +80° C

Environmental

Protection: IP67
NEMA Rating: NEMA 6

Splitter

Reference Information

UL File No.: E152210
CSA File No.: LR6337

Electrical

Voltage: 250V AC/DC
Current: 4.0A

Physical

Connector Face: Nylon 6/6
Molded Body: PVC
Coupling Nut: Zinc diecast with black epoxy coat, Stainless Steel type 303 Nickel-plated Brass
Operating Temperature: -20 to +105° C

Environmental

Protection: IP67
NEMA Rating: NEMA 6

Tee

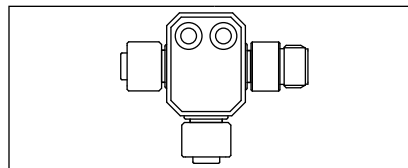

Micro-Bus Drop

Face View (Female)	Type	Engineering No.	Standard Order No.
<p>5 Pole</p> <p>1 - Drain 4 - CAN_H 2 - V+ 5 - CAN_L 3 - V-</p>	Drop Tee	MICT555	130035-0090

Splitter

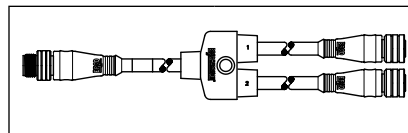

Male-Female/Female

Face View (Female)	Type	Engineering No.	Standard Order No.
<p>5 Pole</p> <p>1 - Drain 4 - CAN H 2 - V+ 5 - CAN L 3 - V-</p>	Splitter Cordset	DNYG001	130039-0396

Note: Sales drawings for all standard order numbers are available on molex.com
*DeviceNet is a trademark of Open DeviceNet Vendor Association (ODVA)

DeviceNet* Brad® Micro-Change® (M12) Passive Multi-Ports

130037

Mini-Change® and Micro-Change® Homerun Connectors



Features and Benefits

- Versions with Home Run connectors and with molded Home Run cable available for maximum system design flexibility
- Rugged housing and connectors designed to withstand harsh industrial environments

Reference Information

UL File No.: E152210
CSA File No.: LR6837

Electrical

Voltage Rating: 10 to 30V DC
Current: 4.0A per port

Physical

Insert: PA
Housing: Glass-filled PBT
Receptacle Housing: Nickel-plated Brass
ID Label: ABS
Operating Temperature: -20 to +90° C

Environmental

Protection: IP67
NEMA Rating: NEMA 6

Home Run Cable

DND—DeviceNet Thin

Rating: 300V, 80° C

Materials: Power—PVC outer jacket with semigrind PVC inner insulation

Data—PE foam inner insulation

Construction: Two shielded pairs, 22 AWG Tin-Copper drain wire between pairs

Cable Jacket Color: Gray

Face View	Ports	Configuration	Wiring Schematic	Drop Cable Length	Drop Cable Configuration			
					Drop with Molded Micro-Change Home Run Cable	Standard Order No.	Drop with Molded Mini-Change Home Run Cable	Standard Order No.
<p>Female Drop Micro-Change</p> <p>1 - Drain 4 - CAN_H 2 - V+ 5 - CAN_L 3 - V-</p>	4			2.0m	DND4500-02	130037-0006	DND4300-02	130037-0005
<p>Male Bus-In Micro-Change</p> <p>1 - Drain 4 - CAH_H 2 - V+ 5 - CAH_L 3 - V-</p>	8			2.0m	DND8500-02	130037-0011	DND8300-02	130037-0010
<p>Male Bus-In Mini-Change</p> <p>1 - Drain 4 - CAN_H 2 - V+ 5 - CAN_L 3 - V-</p>								

Note: Sales drawings for all standard order numbers are available on molex.com

*DeviceNet is a trademark of Open DeviceNet Vendor Association (ODVA)

DeviceNet* Brad® Micro-Change® Passive Multi-Ports

130036/130037
Mini-Change®
Homerun Connectors



Features and Benefits

- Versions with Home Run connectors and with molded home run cable available for maximum system design flexibility
- Rugged housing and connectors designed to withstand harsh industrial environments

Reference Information

UL File No.: E152210
CSA File No.: LR6837

Electrical

Voltage Rating: 10 to 30V DC
Amperage: 4.0A per port

Physical

Insert: PA
Housing: Glass-filled PBT
Receptacle Housing: Nickel-plated Brass
ID Label: ABS
Home Run Connectors: Brad Mini-Change
Operating Temperature: -20 to +90° C

Environmental

Protection: IP67
NEMA Rating: NEMA 6

Face View	Ports	Configuration	Wiring Schematic	Engineering No.	Standard Order No.
<p>Female Drop</p> <p>1 - Drain 4 - CAN_H 2 - V+ 5 - CAN_L 3 - V-</p>	4			DND4200	130037-0004
<p>Male Bus-In</p> <p>1 - Drain 4 - CAN_H 2 - V+ 5 - CAN_L 3 - V-</p>	8			DND8200	130037-0008

*DeviceNet is a trademark of Open DeviceNet Vendor Association (ODVA)

DeviceNet* Brad® Open Style Single-Ended Cordsets

130039

Female
Straight
Thin Media



Features and Benefits

- Over-molded open style of DeviceNet connector provides for environmental protection and cable integrity strain relief
- Variety of form factor, cable type and length options available for maximum flexibility

Physical

Contacts: Bronze
Contact Plating: Gold
Body: Polyamide
Operating Temperature: 0 to 60° C

Environmental

Protection: IP20

Cables

DND—Thin Standard

Rating: 300V 80° C
Outer Jacket: PVC
Inner Insulation: Power—Semi-rigid PVC
Data—PE foam
Construction: Two shielded pairs, 22 AWG Tin-Copper drain wire between pairs
Cable Jacket Color: Gray
UL: CL2, AWM 2464
CSA: FT4 Rated

DNDF—Thin High-Flex

Rating: 300V 80° C
Outer Jacket: PVC
Inner Insulation: Power—Semi-rigid PVC
Data—PE foam
Flexure: Rolling Flex > 1 million cycles at 10x bend radius
Construction: Two foil shielded pairs, 26 AWG Tin-Copper drains between pairs
Cable Jacket Color: Gray
UL : CL3 AWM 20626, Flame UL 158
CSA : AWM I/II A/B, 80° C, 300V FT1

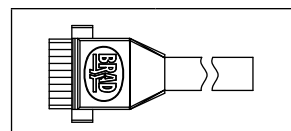

Face View (Female)	Max. Current per Contact	Max. Voltage	Cable Type	Cable Jacket	Wire Size AWG	Cable Diameter	Length	Straight	
								Engineering No.	Standard Order No.
<p>1 - Black (V-) 4 - White (CAH_H) 2 - Blue (CAN_L) 5 - Red (V+) 3 - Bare (Shield Drain)</p>	10.0A	300V AC/DC	Thin Cable	PVC	22/22	7.24mm	1.0m	DND40-M010	130039-0127
Thin, High-Flex			TPE	22/24	7.62mm	1.0m	DNDF40-M010	130039-0545	

Note: Sales drawings for all standard order numbers are available on molex.com
*DeviceNet is a trademark of Open DeviceNet Vendor Association (ODVA)

Configuration Code†
Build-a-Part Number

	Length	Code
Meters	2	M020
	5	M050
	10	M100

DND40A-M010

Coupling Nut Option
Epoxy-Coated Zinc A
Nickel-Brass NB
Stainless Steel SS

Cable Option

†Once an engineering number is created using the configuration code, consult Molex tech support for information regarding any part numbers.

DeviceNet* Open Style-to-Brad® Mini-Change® and Micro-Change® (M12) Double-Ended Cordsets

130039



Features and Benefits

- Over-molded open style of DeviceNet connector provides for environmental protection and cable integrity strain relief
- Variety of form factor, cable type and length options available for maximum flexibility

Electrical

Contacts: Mini-Change—Phosphor Bronze
Micro-Change—Phosphor Bronze
Open—Bronze
Contact Plating: Mini-Change—Gold over Nickel
Micro-Change—Gold over Nickel
Open—Gold

Physical

Body: Mini-Change—Molded PVC
Micro-Change—Molded PVC
Open—Polyamide
Insert: Mini-Change—PVC
Micro-Change—Nylon 6/6
Operating Temperature: Mini-Change—-20 to +80° C
Micro-Change—-20 to +80° C
Open—0 to 60° C

Environmental

Protection: Mini-Change—IP67
Micro-Change—IP67
Open—IP20

Cables

DND—DeviceNet Thin

Rating: 300V 80° C

Materials: Power—PVC outer jacket with semi-rigid PVC inner insulation
Data—PE Foam inner insulation

Construction: Two shielded pairs, 22 AWG Tin Copper drain wire between pairs

Cable Jacket Color: Gray

DNDF—DeviceNet Thin High Flex

Rating: 300V, 80° C

Materials: Power—TPE outer jacket, PVC with Nylon skin inner insulation

Data—PE foam PE foam inner insulation
Flexure: Rolling Flex >1m cycles at 10x bend radius

Construction: Two foil shielded pairs, 26 AWG Tin-Copper drains between pairs

Cable Jacket Color: Gray

Face View Connector	Max. Current per Voltage	Maximum Voltage	Cable Type	Cable Jacket	Cable Diameter	Wire Size AWG	Length	Open-to-Male Straight Mini		Open-to-Male Right Angle Mini	
								Engineering No.	Standard Order No.	Engineering No.	Standard Order No.
 Open 1 - Black (V-) 4 - White (CAH_H) 2 - Blue (CAN_L) 5 - Red (V+) 3 - Bare (Shield Drain)	4.0A	250V	Thin	PVC	7.24mm	22/22	1.0m	DND41A-M010	130039-0132	DND49A-M010	130039-0122
 Male Mini-Change 1 - Drain 4 - CAN_H 2 - V+ 5 - CAN_L 3 - V-			Thin/ Flex Rated	TPE	7.62mm	22/24		DNDF41A-M010	130039-0546	DNDF49A-M010	130039-0547

Face View Connector	Max. Current per Voltage	Maximum Voltage	Cable Type	Cable Jacket (Cable Code)	Cable Diameter	Wire Size AWG	Length	Open-to-Male Straight M12		Open-to-Male Right Angle M12	
								Engineering No.	Standard Order No.	Engineering No.	Standard Order No.
 Open 1 - Black (V-) 4 - White (CAH_H) 2 - Blue (CAN_L) 5 - Red (V+) 3 - Bare (Shield Drain)	4.0A	250V	Thin	PVC	7.24mm	22/22	1.0m	DND42A-M010	130039-0190	DND43A-M010	130039-0204
 Male Micro-Change 1 - Drain 4 - CAN_H 2 - V+ 5 - CAN_L 3 - V-			Thin/ Flex Rated	TPE	7.62mm	22/24		DNDF42A-M010	130039-0548	DNDF43A-M010	130039-0549

Note: Sales drawings for all standard order numbers are available on molex.com
*DeviceNet is a trademark of Open DeviceNet Vendor Association (ODVA)

Configuration Code†
Build-a-Part Number

Meters	Length	Code
	2	M020
	5	M050
	10	M100



†Once an engineering number is created using the configuration code, consult Molex tech support for information regarding any part numbers.

DeviceNet* Open Style-to-Brad® Mini-Change® and Micro-Change® (M12) Receptacle Assemblies

130031/130033/130039

Open-to-Back Panel Mount
Thin Media



Features and Benefits

- Over-molded open style of DeviceNet connector provides for environmental protection and cable integrity strain relief
- Variety of form factor, cable type and length options available for maximum flexibility

Reference Information

UL File No.: E152210

CSA File No.: LR6837

Electrical

Contacts: Mini-Change—Phosphor Bronze

Micro-Change—Phosphor Bronze

Open—Bronze

Contact Plating: Mini-Change—Gold over Nickel

Micro-Change—Gold over Nickel

Open—Gold

Physical

Body: Mini-Change—Molded PVC

Micro-Change—Molded PVC

Open—Polyamide

Insert: Mini-Change—PVC

Micro-Change—Nylon 6/6

Operating Temperature: -20 to +80° C

Environmental

Protection: Mini-Change—IP67

Micro-Change—IP67

Open—IP20

Cables

DND—Thin

Rating: 300V 80° C

Materials: Power—PVC outer jacket with semi-rigid

PVC insulation

Data—PE foam inner insulation

Construction: Two shielded pairs, 20 AWG Tin Copper drain

wire between pairs

Cable Jacket Color: Gray

Face View	Max. Current per Voltage	Maximum Voltage	Cable Type	Cable Jacket	Cable Diameter	Wire Size AWG	Length	Open-to-Mini-Change Receptacle		Open-to-M12 Receptacle	
								Engineering No.	Standard Order No.	Engineering No.	Standard Order No.
<p>Open</p> <p>1 - Black (V-) 4 - White (CAN_H) 2 - Blue (CAN_L) 5 - Red (V+) 3 - Bare (Shield Drain)</p> <p>Male Mini-Change</p> <p>1 - Drain 4 - CAN_H 2 - V+ 5 - CAN_L 3 - V-</p> <p>Male Micro-Change</p> <p>1 - Drain 4 - CAN_H 2 - V+ 5 - CAN_L 3 - V-</p>	4.0A	250V AC/DC	Thin	Polyamide	7.24mm	22/22	1.0m	DND5304-M010	130039-0087		
	4.0A	250V AC/DC	Thin	Polyamide	7.62mm	22/22	0.50m			DND304-M005	130033-0003

Note: Sales drawings for all standard order numbers are available on molex.com
*DeviceNet is a trademark of Open DeviceNet Vendor Association (ODVA)

Configuration Code†
Build-a-Part Number

	Length	Code
Meters	2	M020
	5	M050
	10	M100

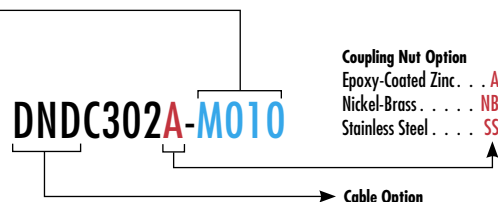

†Once an engineering number is created using the configuration code, consult Molex tech support for information regarding any part numbers.

DeviceNet* Brad® Nano-Change® (M8) Single-Ended Cordsets

130029

Female
Straight, Right Angle
Ultra-Thin Media
Threaded



Features and Benefits

- Rugged IP67 rated connectors for continued connection integrity in industrial environments
- Variety of cable type, connector configuration and cable length options available for maximum flexibility

Physical

Connector Face: PBT
Molded Body: TPE
O-Ring: Viton®
Coupling Nut: Zinc diecast with black epoxy coat
Operating Temperature: PVC—-20 to +80° C

Environmental

Protection: IP67
NEMA Rating: NEMA 6

Cables

D12—Ultra-Thin

Rating: 300V

Materials: Individually Thinned—PVC outer jacket, 26 AWG (19 x 38 AWG) Copper

Power—Semi-rigid PVC insulation

Data—PE foam inner insulation

Construction: Two shielded pairs, 26 AWG Tin Copper drain wire between pairs

Cable Jacket Color: Gray

UL: AWM Style 2095

CSA: AWM I/II A/B, FT4

Face View (Female)	Current	Voltage	Cable Jacket (Cable Type)	Wire Size AWG	Length	Female Straight		Female Right Angle	
						Engineering No.	Standard Order No.	Engineering No.	Standard Order No.
<p>5 Pole</p> <p>1 - Drain 4 - Black 2 - Red 5 - Blue 3 - White</p>	1.68A	60V AC/75V DC	Ultra-Thin	26	1.0m	405000D12M010	130029-0001	405001D12M010	130029-0002

Note: Sales drawings for all standard order numbers are available on molex.com.

Viton® is a registered trademark of E.I. DuPont De Nemours and Company.

*DeviceNet is a trademark of Open DeviceNet Vendor Association (ODVA)

Configuration Code†
Build-a-Part Number

	Length	Code
Meters	2	M020
	5	M050
	10	M100

405000D12M010

Cable Option

†Once an engineering number is created using the configuration code, consult Molex tech support for information regarding any part numbers.

DeviceNet* Brad® Nano-Change® (M8) Single-Ended Cordsets

130029

Male
Straight, Right Angle
Ultra-Thin Media
Threaded



Features and Benefits

- Rugged IP67 rated connectors for continued connection integrity in industrial environments
- Variety of cable type, connector configuration and cable length options available for maximum flexibility

Physical

Connector Face: PBT
Molded Body: TPE
O-Ring: Viton®
Coupling Nut: Zinc diecast with black epoxy coat
Operating Temperature: PVC—-20 to +80° C

Environmental

Protection: IP67
NEMA Rating: NEMA 6

Cables

D12—Ultra-Thin

Rating: 300V
Materials: Individually Thinned—PVC outer jacket, 26 AWG (19 x 38 AWG) Copper
Power—Semi-rigid PVC insulation
Data—PE foam inner insulation
Construction: Two shielded pairs, 26 AWG Tin Copper drain wire between pairs
Cable Jacket Color: Gray
UL: AWM Style 2095
CSA: AWM I/II A/B, FT4

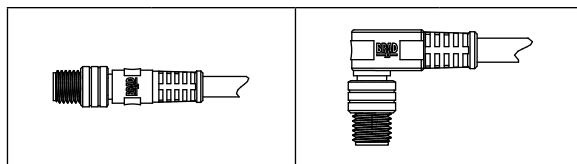

Poles	Current	Voltage	Cable Jacket (Cable Type)	Wire Size AWG	Length	Straight		Right Angle	
						Engineering No.	Standard Order No.	Engineering No.	Standard Order No.
<p>5 Pole</p> <p>1 - Drain 4 - Black 2 - Red 5 - Blue 3 - White</p>	1.68A	60V AC/75V DC	Ultra-Thin	26	1.0m	405006D12M010	130029-0003	405007D12M010	130029-0005

Note: Sales drawings for all standard order numbers are available on molex.com.
Viton® is a registered trademark of E.I. DuPont De Nemours and Company.
*DeviceNet is a trademark of Open DeviceNet Vendor Association (ODVA)

Configuration Code†
Build-a-Part Number

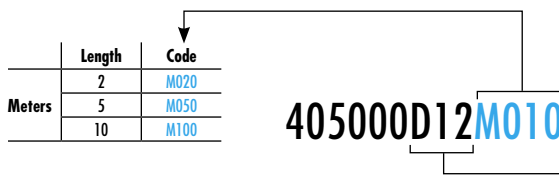

†Once an engineering number is created using the configuration code, consult Molex tech support for information regarding any part numbers.

DeviceNet* Brad® Nano-Change® (M8) Double-Ended Cordsets

130030
Female, Male
Straight, Right Angle
Ultra-Thin Media
Threaded



Features and Benefits

- Rugged IP67 rated connectors for continued connection integrity in industrial environments
- Variety of cable type, connector configuration and cable length options available for maximum flexibility

Physical

Connector Face: PBT
Molded Body: TPE
O-Ring: Viton®
Coupling Nut: Zinc diecast with black epoxy coat
Operating Temperature: PVC—-20 to +80° C

Environmental

Protection: IP67
NEMA Rating: NEMA 6

Cables

D12—Ultra-Thin

Rating: 300V
Materials: Individually Thinned—PVC outer jacket, 26 AWG (19x38 AWG) Copper
Power—Semi-rigid PVC insulation
Data—PE Foam inner insulation
Construction: Two shielded pairs, 26 AWG Tin Copper drain wire between pairs
Cable Jacket Color: Gray
UL: AWM Style 2095
CSA: AWM: 1/II A/B, FT4

Face View (Female)	Current	Voltage	Cable Type	Cable Code	Wire Size AWG	Length	Female Straight-to-Male Straight		Female Straight-to-Male Right Angle		Female Right Angle-to-Male Straight		Female Right Angle-to-Male Right Angle	
							Engineering No.	Standard Order No.	Engineering No.	Standard Order No.	Engineering No.	Standard Order No.	Engineering No.	Standard Order No.
<p>5 Pole 1 - Drain 4 - Black 2 - Red 5 - Blue 3 - White</p>	1.68A	60V AC/ 75V DC	Ultra-Thin	PVC	26	1.0m	445030D12M010	130030-0003	445032D12M010	130030-0004	445031D12M010	130030-0088	445033D12M010	130030-0089

Note: Sales drawings for all standard order numbers are available on molex.com.

Viton® is a registered trademark of E.I. DuPont De Nemours and Company.

*DeviceNet is a trademark of Open DeviceNet Vendor Association (ODVA)

Configuration Code†
Build-a-Part Number

	Length	Code
Meters	2	M020
	5	M050
	10	M100

485030D12M010

→ Cable Option

†Once an engineering number is created using the configuration code, consult Molex tech support for information regarding any part numbers.

DeviceNet* Brad® Micro-Change® (M12)-to-Nano-Change® (M8)

Double-Ended Cordsets

130030

Female, Male
Straight, Right Angle
Ultra-Thin Media
Threaded



Features and Benefits

- Rugged IP67 rated connectors for continued connection integrity in industrial environments
- Variety of cable type, connector configuration and cable length options available for maximum flexibility

Physical

Connector Face: PBT
Molded Body: TPE
O-Ring: Viton®
Coupling Nut: Zinc diecast with black epoxy coat
Operating Temperature: PVC—-20 to +80° C

Environmental

Protection: IP67
NEMA Rating: NEMA 6

Cables

D12—Ultra-Thin

Rating: 300V

Materials: Individually Thinned—PVC outer jacket, 26 AWG (19x38 AWG) Copper

Power—Semi-rigid PVC insulation

Data—PE Foam inner insulation

Construction: Two shielded pairs, 26 AWG Tin Copper drain wire between pairs

Cable Jacket Color: Gray

UL: AWM Style 2095

CSA: AWM I/II A/B, FT4

Double-Ended Connector Face View	Max. Current	Max. Voltage	Cable Type	Cable Code	Wire Size AWG	Length	Female Straight-to-Male Straight		Female Straight-to-Male Right Angle		Female Right Angle-to-Male Straight		Female Right Angle-to-Male Right Angle	
							Engineering No.	Standard Order No.	Engineering No.	Standard Order No.	Engineering No.	Standard Order No.	Engineering No.	Standard Order No.
<p>5 Pole Nano-Change (Female)</p> <p>1 - Drain 4 - Black 2 - Red 5 - Blue 3 - White</p>	1.68A	60V AC/ 75V DC	Ultra-Thin	PVC	24	1.0m	845030D12M010	130030-0027	845032D12M010	130030-0061	845031D12M010	130030-0041	845033D12M010	130030-0070
<p>5 Pole Micro-Change (Female)</p>														

Note: Sales drawings for all standard order numbers are available on molex.com.

Viton® is a registered trademark of E.I. DuPont De Nemours and Company.

*DeviceNet is a trademark of Open DeviceNet Vendor Association (ODVA)

Configuration Code†
Build-a-Part Number

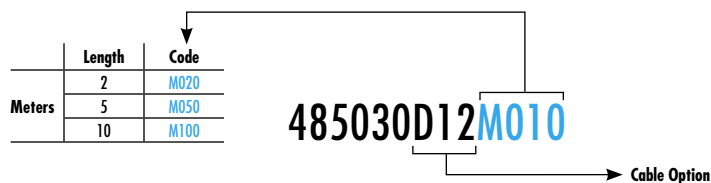

†Once an engineering number is created using the configuration code, consult Molex tech support for information regarding any part numbers.

DeviceNet* Brad® Nano-Change® (M8)-to- Micro-Change® (M12) Double-Ended Cordsets

130030

**Female, Male
Straight, Right Angle
Ultra-Thin Media
Threaded**



Features and Benefits

- Rugged IP67 rated connectors for continued connection integrity in industrial environments
- Variety of cable type, connector configuration and cable length options available for maximum flexibility

Physical

Connector Face: PBT
Molded Body: TPE
O-Ring: Viton®
Coupling Nut: Zinc diecast with black epoxy coat
Operating Temperature: PVC—-20 to +80° C

Environmental

Protection: IP67
NEMA Rating: NEMA 6

Cables

D12—Ultra-Thin

Rating: 300V
Materials: Individually Thinned—PVC outer jacket, 26 AWG (19x38 AWG) Copper
Power—Semi-rigid PVC insulation
Data—PE foam inner insulation
Construction: Two shielded pairs, 26 AWG Tin Copper drain wire between pairs
Cable Jacket Color: Gray
UL: AWM Style 2095
CSA: AWM I/II A/B, FT4

Face View	Current	Voltage	Cable Type	Cable Code	Wire Size AWG	Length	Female Straight-to-Male Straight		Female Straight-to-Male Right Angle		Female Right Angle-to-Male Straight		Female Right Angle-to-Male Right Angle	
							Engineering No.	Standard Order No.	Engineering No.	Standard Order No.	Engineering No.	Standard Order No.	Engineering No.	Standard Order No.
<p>5 Pole Nano-Change (Female)</p> <p>1 - Drain 4 - Black 2 - Red 5 - Blue 3 - White</p> <p>5 Pole Micro-Change (Female)</p>	1.68A	60V AC/ 75V DC	Ultra-Thin	PVC	24	1.0m	485030D12M010	130030-0010	485032D12M010	130030-0091	485031D12M010	130030-0090	485033D12M010	130030-0022

Note: Sales drawings for all standard order numbers are available on molex.com.

Viton® is a registered trademark of E.I. DuPont De Nemours and Company.

*DeviceNet is a trademark of Open DeviceNet Vendor Association (ODVA)

Configuration Code†
Build-a-Part Number

	Length	Code
Meters	2	M020
	5	M050
	10	M100

485030D12M010

→ Cable Option

†Once an engineering number is created using the configuration code, consult Molex tech support for information regarding any part numbers.

DeviceNet* Brad® 14-Port Nano-Change® (M8) Passive Multi-Port

130038

Ultra-Thin Media



Features and Benefits

- Up to 60% space savings over functionally equivalent M12 drop boxes
- Mates with Straight and 90° M8 connectors allowing user to route cable as needed
- Designed to accept Ultra-Thin DeviceNet cabling: Ideal for tight routings and space and for applications requiring small footprints

Physical

Insert: PUR
Housing: Grey, thermo formed ABS
Receptacle Shell: Nickel-plated Brass
Connector Configuration: Periphery Connectors—45°
Center Connectors—90°
Operating Temperature: -0 to +60° C

Electrical

Voltage: 36V DC
Current: 8.0A total per drop box
Grounding: Grounding through mounting holes
LED Indication for Network: Voltage Status
Green—Within DeviceNet Voltage Spec (13-24V)
Red—Overvoltage (>24V)
Yellow—Undervoltage (<13V)

Environmental

Protection: IP65
NEMA Rating: NEMA 6

Connector Face View	Ports	Box Configuration	Wiring Schematic	Engineering No.	Standard Order No.
<p>Female Nano-Change Connector</p> <p>1 - Drain 4 - V- 2 - V+ 5 - CAN_L 3 - CAN_H</p> <p>Male Mini-Change Bus-In</p> <p>1 - Drain 4 - CAN_H 2 - V+ 5 - CAN_L 3 - V-</p> <p>Female Mini-Change Bus-Out</p> <p>1 - Drain 4 - CAN_H 2 - V+ 5 - CAN_L 3 - V-</p>	14			DNTA14114A1	130038-0016

Note: Sales drawings for all standard order numbers are available on molex.com
*DeviceNet is a trademark of Open DeviceNet Vendor Association (ODVA)

DeviceNet* Auxiliary Power Brad® Mini-Change® A-Size Double-Ended Cordset

130010
Internal Thread Female
External Thread Male
Straight, Right Angle



Features and Benefits

- Patented QuadBeam™ contact design for reliability and low resistance
- Flex-rated TC-ER cable

Reference Information

UL File No.: E152210
CSA File No.: LR6837

Electrical

Voltage: 600V AC/DC

Mechanical

Wire Size: 16 AWG

Physical

Connector Face: PVC or TPE
Connector Body: PVC or TPE
Contact: Brass with Gold over Nickel plating
Coupling Nut: Black epoxy-coated Zinc
Cable Jacket Color: Yellow
Cables: K12 and K13—UL Type TC-ER, Flex rated
A38 and A01—UL Type STOOW, extra hard service cord

Environmental

Protection: IP67

Poles (Female View)	Current	Wire Cable Type	Cable Jacket (Cable Code)	Length	Female Straight-to-Male Straight		Female Right Angle-to-Male Right Angle	
					Engineering No.	Standard Order No.	Engineering No.	Standard Order No.
	10.0A	TC-ER	TPE (K12)	2.0m	114030K12M020	130010-0865	114033K12M020	130010-1744
		STOOW	PVC (A38)		114030A38M020	130010-0795	114033A38M020	130010-1823

Note: Sales drawings for all standard order numbers are available on molex.com

*DeviceNet is a trademark of Open DeviceNet Vendor Association

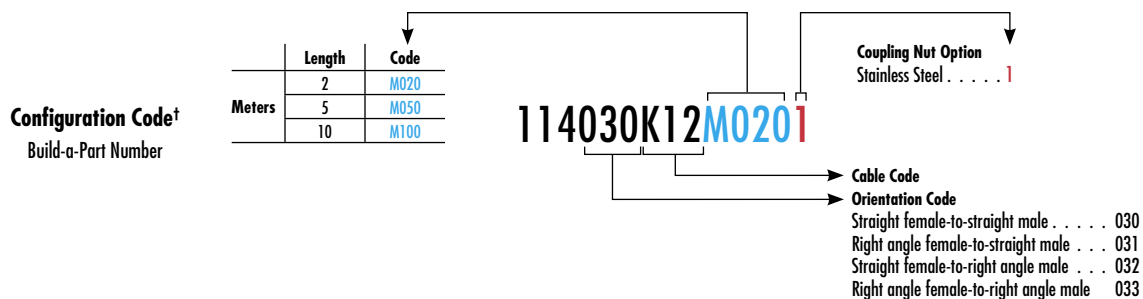

†Once an engineering number is created using the configuration code, consult Molex tech support for information regarding any part numbers.

DeviceNet*
Auxiliary Power
Brad® Mini-Change®
Bulkhead Adapters
130013
Female-Male Straight

Features and Benefits

- Patented QuadBeam™ contact design for reliability and low resistance
- Facilitates through-panel connections

Reference Information

UL File No.: E152210
 CSA File No.: LR6837

Electrical

Voltage: 600V AC/DC

Physical

Connector Face: PVC
 Contact: Brass with Gold over Nickel plating
 Shell Material: Nickel-plated Brass
 Mounting Thread: 7/8"-16 UN-2A
 Operating Temperature: -20 to +105° C

Environmental

Protection: IP67
 NEMA Rating: NEMA 6

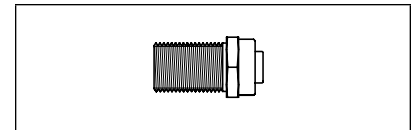

Poles (Female View)	Current	Material Type	Engineering No.	Standard Order No.
	8.0A	Stainless Steel	1R40301	130013-1001
	8.0A	Brass	1R4030	130013-0388

Note: Sales drawings for all standard order numbers are available on molex.com
 *DeviceNet is a trademark of Open DeviceNet Vendor Association (ODVA)

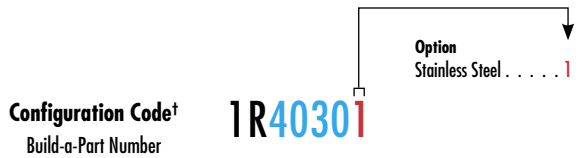

†Once an engineering number is created using the configuration code, consult Molex tech support for information regarding any part numbers.

DeviceNet* Auxiliary Power Brad® Mini-Change® Field Attachable Connectors

130017
Internal Thread Female
External Thread Male



Features and Benefits

- Patented Quad-Beam™ contact design for reliability and low resistance

Reference Information

CSA File No.: LR6837

Electrical

Voltage: 600V AC/DC

Physical

Connector Face: Polyurethane

Connector Body: Nylon

Contact: Brass with Gold over Nickel plating

Coupling Nut: Nickel-plated Brass

Wire Size: 15 to 24 AWG

Cable Range: 5.08 to 11.43mm (.200 to .450")

Operating Temperature: -20 to +80° C

Environmental

Protection: IP67

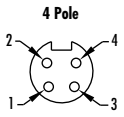
Poles (Female View)	Current	Coupling Type	Female Straight		Male Straight	
			Engineering No.	Standard Order No.	Engineering No.	Standard Order No.
4 Pole 	10.0A	Internal Thread	1A4000-34	130017-0015		
		External Thread			1A4006-34	130017-0020

Note: Sales drawings for all standard order numbers are available on molex.com

*DeviceNet is a trademark of Open DeviceNet Vendor Association (ODVA)

DeviceNet* Auxiliary Power Brad® Mini-Change® Power Taps

130039

Fused Power Tap Blocks



Features and Benefits

- Connects power supply to DeviceNet trunk line in convenient plug/play fashion
- Easily replaceable fuses protect bus and connected components from over-current
- Provides LED indication of power and polarity for simple diagnostics

Electrical

Fuse Protection: 4.0A
Voltage: 50V DC

Physical

Housing: PBT
Port Shell Material: Epoxy-coated Zinc
Connector Face: PVC
Contacts: Brass with Gold over Nickel plating

Environmental

Protection: IP67

Left Port Configuration	Drop Port Configuration	Right Port Configuration	LED Indicator	Box Configuration	Schematic	Engineering No.	Standard Order No.
<p>5 Pole Female</p> <p>1 - Drain 4 - CAH_H 2 - V+ 5 - CAH_L 3 - V-</p>	<p>4 Pole Male</p> <p>1 - Vaux+ 2 - Vaux- 3 - Vaux+ 4 - Vaux-</p>	<p>5 Pole Male</p> <p>1 - Drain 4 - CAH_H 2 - V+ 5 - CAH_L 3 - V-</p>	Yes			DN-PT1	130039-0390
<p>5 Pole Female</p> <p>1 - Drain 4 - CAH_H 2 - V+ 5 - CAH_L 3 - V-</p>	<p>4 Pole Male</p> <p>1 - Vaux+ 2 - Vaux- 3 - Vaux+ 4 - Vaux-</p>	<p>5 Pole Female</p> <p>1 - Drain 4 - CAH_H 2 - V+ 5 - CAH_L 3 - V-</p>	Yes			DN-PT2	130039-0391
<p>5 Pole Male</p> <p>1 - Drain 4 - CAN_H 2 - V+ 5 - CAN_L 3 - V-</p>	<p>4 Pole Male</p> <p>1 - Vaux+ 2 - Vaux- 3 - Vaux+ 4 - Vaux-</p>	<p>5 Pole Female</p> <p>1 - Drain 4 - CAH_H 2 - V+ 5 - CAH_L 3 - V-</p>	Yes			DN-PT3	130039-0393

Note: Sales drawings for all standard order numbers are available on molex.com

*DeviceNet is a trademark of Open DeviceNet Vendor Association (ODVA)

DeviceNet* Auxiliary Power Brad® Mini-Change® Machine E-Stop Tees

130035



Features and Benefits

- Patented Quad Beam™ contact provides high reliability and low resistance
- Provides quick connection of auxiliary power for networks
- Provides interruption to auxiliary power for safe installation

Electrical

Current: 8.0A
Voltage: 50V

Physical

Connector Face: PVC
Connector Body: TPE
Contacts: Brass with Gold over Nickel plate
Couplers: Epoxy-coated Zinc
Operating Temperature: -20 to +105° C

Environmental

Protection: IP67

Poles (Female View)	Configuration	Schematic	Engineering No.	Standard Order No.
<p>4 Pole</p>			DNETAUXPT	130035-0085
			DNEST	130035-0081
			DNESJ	130035-0077
			DNAPT	130035-0072

Note: Sales drawings for all standard order numbers are available on molex.com
*DeviceNet is a trademark of Open DeviceNet Vendor Association (ODVA)

DeviceNet* Auxiliary Power Brad® Micro-Change® and Ultra-Lock® (M12) Single-Ended Cordsets

120079

Female, Pigtails
Straight, Right Angle



Features and Benefits

- M12 single keyway (A-Coding) IEC compliant cordset assemblies
- 5-pole version for auxiliary power to devices in DeviceNet installations
- Wide selection of cables to fit applications
 - PVC cables for light, cost-sensitive industrial applications
 - TPE cables for continuous-flex applications. Also ideal for welding cells, cable is weld slag resistant
 - Other versions available

Reference Information

UL File No.: E152210
CSA File No.: LR6837

Physical

Connector Body: PUR (TPE for K03)
Contact Carries: Polyamide
O-ring: Viton® (EPDM for A09 cables)
Coupling Nut: Nickel-plated Brass (Teflon® coated for K03)
Contacts: Copper alloy with Gold over Nickel plating
Cables: A09—Yellow PVC jacket, 22 AWG PVC conductors, 300V, UL AWM2661
K03—Yellow TPE jacket, 18 AWG PVC conductors, 300V, UL PLTC-ER, +5M flex life (torsion and bending)

Environmental

Protection: IP67
NEMA Rating: NEMA 6

Micro-Change Cordsets

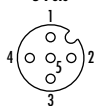
Poles	Max. Current per Contact	Max. Voltage	Cable Type	Cable Jacket (Cable Code)	Wire Size AWG	Length	Female Straight		Female Right Angle	
							Engineering No.	Standard Order No.	Engineering No.	Standard Order No.
5 Pole 	4.0A	250V AC/DC	UL 2661	PVC (A09)	22	2.0m	805000A09M020	120065-0471	805001A09M020	120065-1697
			PLTC-ER	TPE (K03)	18		805000K03M020	120065-1367	805001K03M020	120065-1720

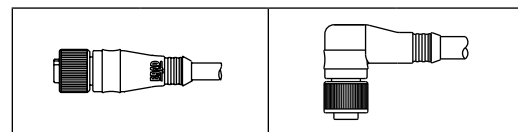

Ultra-Lock Cordsets

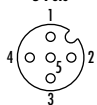
Poles	Max. Current per Contact	Max. Voltage	Cable Type	Cable Jacket (Cable Code)	Wire Size AWG	Length	Female Straight		Female Right Angle	
							Engineering No.	Standard Order No.	Engineering No.	Standard Order No.
5 Pole 	4.0A	250V AC/DC	UL 2661	PVC (A09)	22	2.0m	W05000A09M020	120079-0109	W05001A09M020	120079-0223

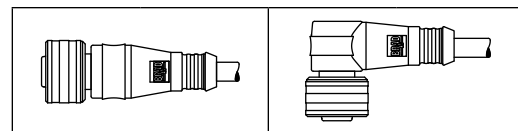

Note: Sales drawings for all standard order numbers are available on molex.com.

Teflon® and Viton® are registered trademarks of E.I. DuPont De Nemours and Company.

*DeviceNet is a trademark of Open DeviceNet Vendors Association (ODVA)

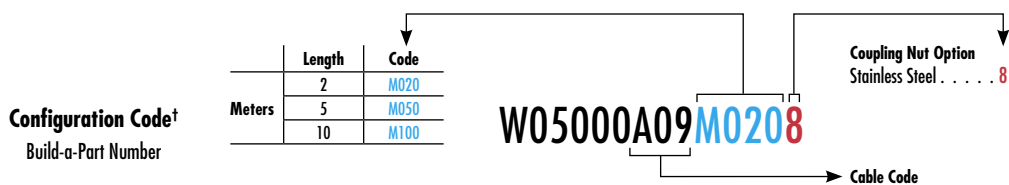

†Once an engineering number is created using the configuration code, consult Molex tech support for information regarding any part numbers.

DeviceNet* Auxiliary Power Brad® Micro-Change® and Ultra-Lock® (M12) Double-Ended Cordsets

120080

**Female Straight-to-Male Straight,
Female Right Angle-to-Male
Right Angle**



Features and Benefits

- M12 single keyway (A-Coding) IEC compliant cordset assemblies
- 5-pole version for auxiliary power to devices in DeviceNet installations
- Wide selection of cables to fit applications
 - PVC cables for light, cost-sensitive industrial applications
 - TPE cables for continuous-flex applications. Also ideal for welding cells, cable is weld slag resistant
 - Other versions available

Reference Information

UL File No.: E152210
CSA File No.: LR6837

Physical

Connector Body: PUR (TPE for K03)
Contact Carries: Polyamide
O-ring: Viton® (EPDM for A09 cables)
Coupling Nut: Nickel-plated Brass (Teflon® coated for K03)
Contacts: Copper alloy with Gold over Nickel plating
Cables: A09—Yellow PVC jacket, 22 AWG PVC conductors, 300V, UL AWM2661
K03—Yellow TPE jacket, 18 AWG PVC conductors, 300V, UL PLTC-ER, +5M flex life (torsion and bending)

Environmental

Protection: IP67
NEMA Rating: NEMA 6

Micro-Change Cordsets

Poles (Female View)	Max. Current per Contact	Max. Voltage	Cable Type	Cable Jacket (Cable Code)	Wire Size AWG	Length	Female Straight-to-Male Straight		Female Right Angle-to-Male Right Angle	
							Engineering No.	Standard Order No.	Engineering No.	Standard Order No.
	4.0A	250V AC/DC	UL 2661	PVC (A09)	22	1.0m	885030A09M010	120066-0427	885033A09M010	120066-1634
			PLTC-ER	TPE (K03)	18		885030K03M010	120066-1034	885033K03M010	120066-1421

Ultra-Lock Cordsets

Poles (Female View)	Max. Current per Contact	Max. Voltage	Cable Type	Cable Jacket (Cable Code)	Wire Size AWG	Length	Female Straight-to-Male Straight		Female Right Angle-to-Male Right Angle	
							Engineering No.	Standard Order No.	Engineering No.	Standard Order No.
	4.0A	250V AC/DC	UL 2661	PVC (A09)	22	1.0m	WW5030A09M010	120080-0325	WW5033A09M010	120080-0431

Note: Sales drawings for all standard order numbers are available on molex.com.

Teflon® and Viton® are registered trademarks of E.I. DuPont De Nemours and Company.

*DeviceNet is a trademark of Open DeviceNet Vendors Association (ODVA)

Configuration Code†
Build-a-Part Number



†Once an engineering number is created using the configuration code, consult Molex tech support for information regarding any part numbers.

DeviceNet* Auxiliary Power Brad® Micro-Change® and Ultra-Lock® (M12) Receptacles

120070

Front Panel Mount
Bulkhead Pass-Through



Features and Benefits

- M12 single keyway (A-Coding) IEC compliant panel mount receptacles
- 5-pole version for auxiliary power to devices in DeviceNet installations
- Fully potted assemblies provide IP67/68 protection for harsh environments

Physical

Shell: Nickel-plated Brass
Contact Carries: Polyamide
O-ring: M12—Red Viton®
Panel—Black Viton
Contacts: Copper alloy with Gold over Nickel plating
Wire PVC Insulation: 300V, 80° C, UL1061, 22 AWG (3-5 poles) and 24 AWG (8 poles)

Environmental

Protection: IP67
NEMA Rating: NEMA 6

Poles (Female View)	Max. Current per Contact	Max. Voltage	Configuration		Configuration		Configuration	
			Engineering No.	Standard Order No.	Engineering No.	Standard Order No.	Engineering No.	Standard Order No.
	4.0A	250V AC/DC	Micro-Change (M12), 1/4"-18NPT, Front Panel Mount		Ultra-Lock Enabled, 1/2"-14NPT, Front Panel Mount		Micro-Change (M12), Bulkhead Pass-thru Receptacle	
			PVC leads, UL1061		PVC leads, UL1061		N/A	
			22 AWG		22 AWG			
			12"		12"			
			8R5A00A18A120	120070-0201	WR5000A18A120	120084-0016	8R5L30	120070-0237

Note: Viton® is a registered trademark of E.I. DuPont De Nemours and Company.
*DeviceNet is a trademark of Open DeviceNet Vendor Association (ODVA)

Configuration Code†
Build-a-Part Number

	Length	Code
Feet	1.0	A120
	3.0	F030
Meters	0.3	C300
	1.0	M010

8R5A00A18A120

†Once an engineering number is created using the configuration code, consult Molex tech support for information regarding any part numbers.

DeviceNet* Auxiliary Power Field Attachable Brad® Micro-Change® and Ultra-Lock® (M12) Connectors

120085
Female, Male
Straight



Features and Benefits

- Allows field termination of cables to IEC compliant M12 A-Coding connector
- Contact carries with screw terminals provide easy field termination of conductors
- 5-pole version for auxiliary power to devices in DeviceNet installations
- Back end housing and cable gland provides IP67 protection and strain relief

Physical

Connector Body: PA
Contact Carries: PA
O-ring: Viton®
Coupling Nut: Nickel-plated Brass
Contacts: Copper alloy with Gold over Nickel plating
Termination: Screw down terminals, accepts conductors up to 18 AWG (0.75mm²)

Environmental

Protection: IP67
NEMA rating: NEMA 6

Micro-Change

Poles (Female View)	Max. Current per Contact	Max. Voltage	Cable Diameter Range	Female Straight		Male Straight	
				Engineering No.	Standard Order No.	Engineering No.	Standard Order No.
5 Pole 	4.0A	250V AC/DC	4.10-8.10mm (.161-.319")	8A5000-32	120071-0043	8A5006-32	120071-0047

Ultra-Lock

Poles (Female View)	Max. Current per Contact	Max. Voltage	Cable Diameter Range	Female Straight		Male Straight	
				Engineering No.	Standard Order No.	Engineering No.	Standard Order No.
5 Pole 	4.0A	250V AC/DC	4.10-8.10mm (.161-.319")	WA5000-32	120085-0014	WA5006-32	120085-0006

Note: Viton® is a registered trademark of E.I. DuPont De Nemours and Company.





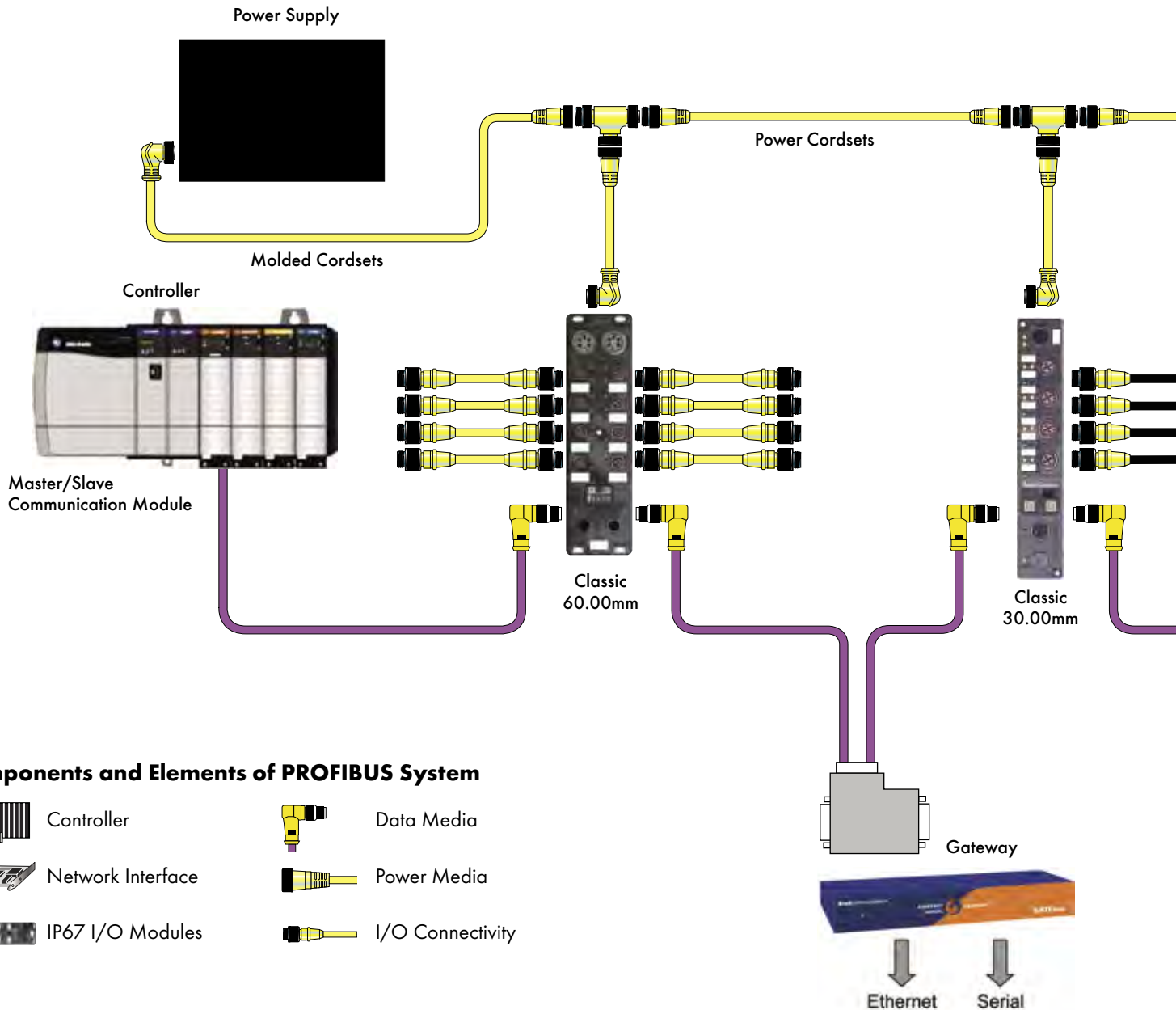

*DeviceNet is a trademark of Open DeviceNet Vendor Association (ODVA)

Brad® PROFIBUS*

Brad products give the user and designer of a PROFIBUS system a complete communication and connectivity solution—from scanner card to media infrastructure to IP67 I/O connections and diagnostics. You can select which control engine you want, whether it is PC- or PLC-based; we get you onto the network. You can choose which control architecture—centralized or distributed—that makes the most sense to you. Whether you are connecting motor controllers, valve banks or sensors, we ensure that connectivity to those points are there.



Components and Elements of PROFIBUS System

- | | | | |
|--|-------------------|---|------------------|
|  | Controller |  | Data Media |
|  | Network Interface |  | Power Media |
|  | IP67 I/O Modules |  | I/O Connectivity |

PROFIBUS*

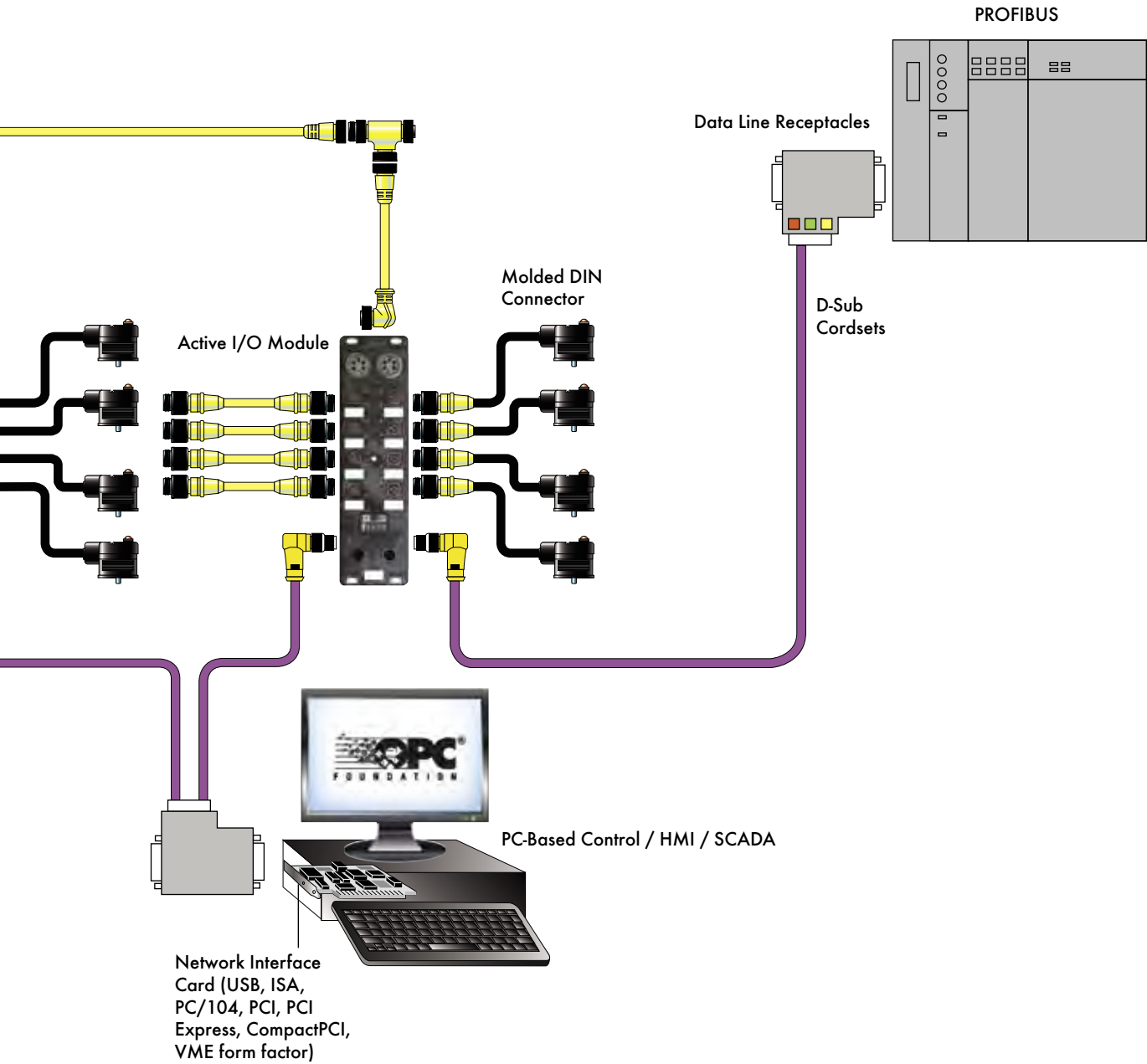

* PROFIBUS is a trademark of PROFIBUS International.

Brad® Direct-Link® Network Interface Card

112035 PROFIBUS* Adapter for SCADA/HMI



Features and Benefits

- Allow to communicate with Siemens Simatic® S5 and S7 PLC series
- All PROFIBUS protocols run simultaneously
- Fast data acquisition between PC-based applications and industrial devices connected to Profibus
- All protocols included in the package
- Best choice for HMI/SCADA applications

Description

- Engineering Tools:
 - Engineering console
 - Test and diagnostic tools
- Compatible Data Servers:
 - OPC DA v3.0, 2.05 and 1.0a
 - Wonderware® DAServer (XP only)
 - Wonderware IO (SuiteLink/FastDDE) (XP only)
- Includes Development Libraries
- Windows compatibility (32-bit): 7, 2008 Server, Windows Vista®, 2003 Server, Windows XP®

Included Hardware/Software

- High-speed USB Adapter, version 2.0 or 1.1
- 1 PROFIBUS port, DB9 female, Galvanic insulation 500V
- Speed: 9.6 Kbps up to 12 Mbps
- Power Supply: 5V through USB (no external supply required)

Compatible Protocols

- Master DP-V0 DP-V1, Class-1 and Class-2
- S7/MPI Master for S7-300 and S7/400
- S7/MPI Slave for S7-200
- S5 for Simatic S5 (95U, 115U, 135U, 155U)

Conformance

- RoHS compliant
- CE
- UL
- cUL

Description	Engineering No.	Standard Order No.
Direct-Link™ USB Adapter for MPI, Full access (DLL/OPC/WW IO)	DRL-MPI-USB	112035-0001
Direct-Link™ USB Adapter for MPI, Library access only (DLL)	DRL-MPI-USB-DLL	112035-0002
Direct-Link™ USB Adapter for all PROFIBUS, Full access (DLL/OPC/WW IO)	DRL-PFB-USB	112026-0014
Direct-Link™ USB Adapter for PROFIBUS, Library access only (DLL)	DRL-PFB-USB-DLL	112026-0015

*PROFIBUS is a trademark of PROFIBUS International

Brad® applicom® Network Interface Card

112013 PROFIBUS*-DP for PC-Based Control and SCADA/HMI



Features and Benefits

- Deterministic data acquisition for real time PC-based control applications
- On board co-processor eliminates data bottlenecks, ensuring delivery of time critical information
- Very easy-to-use; no knowledge of protocol required
- Remote access via serial connection; enables configuration and diagnostic when using real time OS (VxWorks, QNX, etc)
- Run Master and Slave modes simultaneously

Description

- Auto mapping of IO in card DPRAM
- IO exchange up to 14 Kbytes
- Hardware and software Watchdog
- Auto-Boot (Configuration stored in Flash)
- Engineering Tools:
 - Engineering console with automatic test and diagnostic tools
- Compatible Data Servers:
 - OPC DA v3.0, 2.05 and 1.0a
 - Wonderware® DAServer (XP only)
 - Wonderware IO (SuiteLink/FastDDE) (XP only)
- Includes Development Libraries
- Supported OS:
 - Windows (32-bit and 64-bit): 7, 2008 Server, Windows Vista®, 2003 Server, Windows XP®/XP Embedded
 - Others: Linux, VxWorks, RTX VenturCom

Included Hardware/Software

- PC/104 bus
- 8 Mb SDRAM; 512 Kb Flash Memory
- 1 Digital Input + 1 Digital Output
- 1 Profibus port, Galvanic insulation 500V
- Connector: HE13 2x5 pins or DB9 female
- Speed: 9.6 Kbps up to 12 Mbps
- LEDs for system status and communications status

Compatible Protocols

- Master DP-V0 Class-1 and Class-2
- Master DP-V1 Class-1 and Class-2
- Slave DP-V0 (passive)

Conformance

- RoHS compliant
- CE
- OPC certified

Description	Engineering No.	Standard Order No.
PCU-DPIO PCI Network Interface Card for PROFIBUS-DP, HE13 connector	DRL-DPM-104	112013-0003

*PROFIBUS is a trademark of PROFIBUS International

Brad® SST™ Network Interface Card

112013 PROFIBUS*-DP for High-Speed PC-Based Control



Features and Benefits

- High speed deterministic communication for control applications
- OEM ready, hardware and software components provided separately
- CommDTM driver for FDT Frame engineering software (PACTware™, FieldCare™, FieldMate™, etc)
- On board FPGA eliminates data bottlenecks, ensuring delivery of time critical information

Description

- Highly customizable Profibus access via Direct DPRAM services
 - Configuration
 - Diagnostic
 - Process Data
- Manage DP Master and Slave modes simultaneously
- Auto-Boot (Configuration stored in Flash)
- Engineering Tools: Configuration console (optional) Test and diagnostic tools (optional)
- OPC DA Server v3.0 (optional)
- Supported OS:
 - Windows (32-bit): Windows Vista®, 2003 Server, Windows XP®
 - Others: Open, documented memory map interface with C source code samples and Windows 32-bit DLLs for custom driver development

Included Hardware/Software

- PC/104 bus
- 1 PROFIBUS port, DB9 female, Galvanic insulation 1000V
- Speed: 9.6 Kbps up to 12 Mbps
- LEDs for system status and communications status

Compatible Protocols

- Master DP-V0 Class-1 and Class-2
- Master DP-V1 Class-1 and Class-2
- Slave DP-V0
- FDL Send/Receive

Conformance

- RoHS compliant
- CE
- FDT certified

Description	Engineering No.	Standard Order No.
PB3 PC/104 Network Interface Card for PROFIBUS-DP	SST-PB3-104	112013-0013
PB3 PC/104 Network Interface Card for PROFIBUS-DP, Bulk of 25	SST-PB3-104-B25	112013-0015
PROFIBUS Configuration and Diagnostic Console, Single license with Parallel key	SST-PB3-CNF-P	112030-0008
PROFIBUS Configuration and Diagnostic Console, Single license with USB key	SST-PB3-CNF-U	112030-0009
PROFIBUS OPC DA Server, Single license code	SST-PB3-OPC	112028-0030

*PROFIBUS is a trademark of PROFIBUS International

Brad® Direct-Link® Network Interface Card

112034
PROFIBUS* for SCADA/HMI



Features and Benefits

- Economical solution
- Dedicated for communication with Siemens Simatic® S7 PLC series
- Ideal for OEM applications
- Best choice for light HMI/SCADA applications

Description

- Engineering Tools:
 - Engineering console
 - Test and diagnostic tools
- Compatible Data Servers:
 - OPC DA v3.0, 2.05 and 1.0a
 - Wonderware® DAServer (XP only)
 - Wonderware IO (SuiteLink/FastDDE) (XP only)
- Includes Development Libraries
- Windows® compatibility (32-bit): Seven, 2008 Server, Windows Vista®, 2003 Server, Windows XP®/XP Embedded

Included Hardware/Software

- PCI Universal bus 3.3V/5V (PCI-X compatible)
- Hardware Plug and Play
- 1 PROFIBUS port, DB9 female, Galvanic insulation 500V
- Speed: 9.6 Kbps up to 12 Mbps

Compatible Protocols

- S7/MPI Master for S7-300 and S7/400
- S7/MPI Slave for S7-200

Conformance

- RoHS compliant
- CE
- OPC certified

Description	Engineering No.	Standard Order No.
Direct-Link® USB Adapter for MPI, Full access (DLL/OPC/WW IO)	DRL-MPI-PCU	112034-0018

*PROFIBUS is a trademark of PROFIBUS International

Brad® applicom® Network Interface Card

112011
PROFIBUS* for SCADA/HMI



Features and Benefits

- Allow communication with Siemens Simatic® S5 and S7 PLC series
- All PROFIBUS protocols run simultaneously
- On board co-processor eliminates data bottlenecks, ensuring delivery of time critical information
- All protocols are included
- Best choice for HMI/SCADA applications
- Combo offer: PROFIBUS + Ethernet
- Economical version dedicated to Siemens Simatic S7 Series

Description

- Engineering Tools:
 - Engineering console
 - Test and diagnostic tools
- Compatible Data Servers:
 - OPC DA v3.0
 - Wonderware® DAServer (XP only)
 - Wonderware IO (SuiteLink/FastDDE) (XP only)
- Includes Development Libraries
- Supported OS:
 - Windows (32-bit and 64-bit): 7, 2008 Server, Windows Vista®, 2003 Server, Windows XP®/XP Embedded
 - Others: Linux, VxWorks, RTX VenturCom

Included Hardware/Software

- Bus Format
 - PCI Universal bus 3.3V/5V (PCI-X compatible)
 - PCI Express 1x
- Hardware Plug and Play
- AMD SC520
- 16 Mb SDRAM
- 4 Mb Flash Memory
- 1 PROFIBUS port, DB9 female, Galvanic insulation 500V
- Speed: 9.6 Kbps up to 1.5 Mbps

Compatible Protocols

- Master DP-V0, Class-1 and Class-2
- S7/MPI Client*
- FDL S5 Master
- PPI/PPI+ Master†
- Free FDL Send/Receive*

Conformance

- RoHS compliant
- CE
- OPC certified
- PCI Express certified

Description	Engineering No.	Standard Order No.
PCU1500S7 PCI Network Interface Card for Siemens S7	APP-PS7-PCU-C	112011-0006
PCIE1500S7 PCI Express Network Interface Card for Siemens S7	APP-PS7-PCIE	112011-5027
PCU1500PFB PCI Network Interface Card for PROFIBUS	APP-PFB-PCU-C	112011-0004
PCIE1500PFB PCI Express Network Interface Card for PROFIBUS	APP-PFB-PCIE	112011-5026
PCU1500PFB PCI Network Interface Card for PROFIBUS + Ethernet	APP-EPB-PCU-C	112000-0001
PCIE1500PFB PCI Express Network Interface Card for PROFIBUS + Ethernet	APP-EPB-PCIE	112000-5028

*PROFIBUS is a trademark of PROFIBUS International

†Protocols compatible with PCU1500S7 and PCIE1500S7

Brad® applicom® Network Interface Card

112011 PROFIBUS* for PC-Based Control and SCADA/HMI



Features and Benefits

- Deterministic data acquisition for real time control applications
- On board co-processor eliminates data bottlenecks, ensuring delivery of time critical information
- Very easy-to-use; no knowledge of protocol required
- Remote access via TCP/IP connection; enables configuration and diagnostic when using real time OS (VxWorks, QNX, etc)
- Run Master and Slave modes simultaneously

Description

- Auto mapping of IO in card DPRAM
- Hardware and software Watchdog
- Auto-Boot (Configuration stored in Flash)
- Engineering Tools:
 - Engineering console with automatic test and diagnostic tools
- Compatible Data Servers:
 - OPC DA v3.0, 2.05 and 1.0a
 - Wonderware® DAServer (XP only)
 - Wonderware IO (SuiteLink/FastDDE) (XP only)
- Includes Development Libraries
- Supported OS:
 - Windows® (32-bit and 64-bit): 7, 2008 Server, Windows Vista®, 2003 Server, Windows XP®/ XP Embedded
 - Others: Linux, VxWorks, RTX VenturCom

Included Hardware/Software

- Bus Format
 - PCI Universal bus 3.3V/5V (PCI-X compatible)
 - PCI Express 1x
- Hardware Plug and Play
- AMD SC520
- 16 Mb SDRAM; 4 Mb Flash Memory
- 1 Digital Input + 1 Digital Output
- 1 PROFIBUS port, DB9 female, Galvanic insulation 500V
- Speed: 9.6 Kbps up to 12 Mbps

Compatible Protocols

- Master DP-V0 Class-1 and Class-2
- Master DP-V1 Class-1 and Class-2
- Slave DP-V0 (passive)

Conformance

- RoHS compliant
- CE
- OPC certified
- PCI Express certified

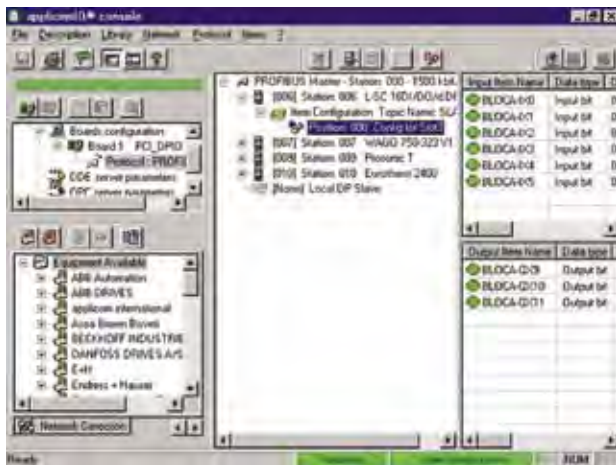

Configuration Console



Device Diagnostics

Description	Engineering No.	Standard Order No.
PCU-DPIO PCI Network Interface Card for PROFIBUS-DP	DRL-DPM-PCU	112011-0008
PCIE-DPIO PCI Express Network Interface Card for PROFIBUS-DP	DRL-DPM-PCIE	112011-5028

*PROFIBUS is a trademark of PROFIBUS International

Brad® SST™ Network Interface Card

112011 PROFIBUS*-DP for High-Speed PC-Based Control



Features and Benefits

- High-speed deterministic communication for PC-Based control applications
- OEM ready, hardware and software components provided separately
- CommDTM driver for FDT Frame engineering software (PACTware™, FieldCare™, FieldMate™, etc)
- On board FPGA eliminates data bottlenecks, ensuring delivery of time critical information
- Available with 1 or 2 PROFIBUS channels
- Typical application:
 - PC-Based control
 - Network diagnostics
 - Custom OEM system
 - Monitoring
 - Data storage

Description

- Highly customizable PROFIBUS access via Direct DPRAM services
 - Configuration
 - Diagnostic
 - Process Data
- Manage DP Master and Slave modes simultaneously
- Auto-Boot (Configuration stored in Flash)
- Engineering Tools:
 - Configuration console (optional)
 - Test and diagnostic tools (optional)
- OPC DA Server v3.0 (optional)
- Supported OS:
 - Windows (32-bit): Windows Vista®, 2003 Server, Windows XP®
 - Others: Open, documented memory map interface with C source code samples and Windows 32-bit DLLs for custom driver development

Included Hardware/Software

- Bus Format
 - PCI Universal bus 3.3V/5V (PCI-X compatible)
 - PCI Express 1x
- 1x or 2x PROFIBUS ports, DB9 female, Galvanic insulation 1000V
- Speed: 9.6 Kbps up to 12 Mbps
- LEDs for system status and communications status

Compatible Protocols

- Master DP-V0 Class-1 and Class-2
- Master DP-V1 Class-1 and Class-2
- Slave DP-V0
- FDL Send/Receive

Conformance

- RoHS compliant
- CE
- PCI Express certified
- FDT Certified

Description	Engineering No.	Standard Order No.
PCI Network Interface Card for PROFIBUS-DP, 1 Channel, DLL+ CommDTM	SST-PB3-PCU	112011-0021
PCI Network Interface Card for PROFIBUS-DP, 1 Channel, DLL+CommDTM, Bulk of 25	SST-PB3-PCU-B25	112011-0024
PCI Network Interface Card for PROFIBUS-DP, 2 Channels, DLL+ CommDTM	SST-PB3-PCU-2	112011-0022
PCI Network Interface Card for PROFIBUS-DP, 2 Channels, DLL+CommDTM, Bulk of 25	SST-PB3-PCU-2-B	112011-0027
PCI Express Network Interface Card for PROFIBUS-DP, 1 Channel, DLL+CommDTM	SST-PB3-PCIE-1	112011-0031
PCI Express Network Interface Card for PROFIBUS-DP, 2 Channels, DLL+CommDTM	SST-PB3-PCIE-2	112011-0032
PROFIBUS Configuration and Diagnostic Console, Single license with Parallel key	SST-PB3-CNF-P	112030-0008
PROFIBUS Configuration and Diagnostic Console, Single license with USB key	SST-PB3-CNF-U	112030-0009
PROFIBUS OPC DA Server, Single license code	SST-PB3-OPC	112028-0030

*PROFIBUS is a trademark of PROFIBUS International

Brad® SST™ Network Interface Card

112011 Multi-Slave PROFIBUS*-DP for Simulation



Features and Benefits

- Emulates or monitors 1 to 125 DP Slaves using one physical PROFIBUS connection
- Ideal for full load network testing of DP Master
- Use to connect OI/HMI applications to Profibus-DP
- Reduced commissioning time; quickly differentiate between wiring, devices, and network problems by comparing real-world results with the emulation
- Passive PROFIBUS connection; network traffic is not affected

Description

- Monitor up to 125 devices
 - Avoids 244 bytes in and 244 bytes out limitation
 - Connects as a passive station, does not affect existing network traffic
 - View input and output data for each slave
 - View slave diagnostic and parameterization data for each slave
- Emulate up to 125 devices
 - Virtually any PROFIBUS DP slave device (e.g. drives, motors, I/O) can be emulated to any PROFIBUS master including DCS, PLC and PC control
 - Use with PICS Simulation™ software and other third party simulation software
 - Several DP Class-1 masters can communicate to one PROFIBUS multi-slave card
- Engineering Tools:
 - Configuration console
 - Test and diagnostic tools
- OPC DA Server v3.0
- Supported Operating System:
 - Windows 32-bit: NT, 2000, Windows XP®
 - Open, documented memory map interface with example C source code and Windows 32-bit DLLs for custom driver development

Included Hardware/Software

- PCI bus 5V
- Hardware plug and play
- 1 PROFIBUS port, DB9 female and 9-pin Phoenix , Galvanic insulation 1000V
- Speed: 9.6 Kbps up to 12 Mbps
- LEDs for system status and communications status

Compatible Protocols

- DP-V0 Slave

Conformance

- CE

Description	Engineering No.	Standard Order No.
PCI Network Interface Card for PROFIBUS-DP Multi-Slave, 1 Channel	SST-PBMS-PCI	112011-0025

*PROFIBUS is a trademark of PROFIBUS International

Brad[®] applicom[®] Network Interface Card

112018 PROFIBUS* for PC-Based Control and SCADA/HMI



Features and Benefits

- Deterministic data acquisition for real time control applications
- Onboard co-processor eliminates data bottlenecks, ensuring delivery of time critical information
- Very easy-to-use; no knowledge of protocol required
- Remote access via TCP/IP connection; enables configuration and diagnostic when using real time OS (VxWorks, QNX, etc)
- Run Master and Slave modes simultaneously

Description

- Auto mapping of IO in card DPRAM
- Hardware and software Watchdog
- Auto-Boot (Configuration stored in Flash)
- Engineering Tools:
 - Engineering console with automatic test and diagnostic tools
- Compatible Data Servers:
 - OPC DA v3.0, 2.05 and 1.0a
 - Wonderware[®] DAServer (XP only)
 - Wonderware IO (SuiteLink/FastDDE) (XP only)
- Includes Development Libraries
- Supported OS:
 - Windows (32-bit and 64-bit): Seven, 2008 Server, Windows Vista[®], 2003 Server, Windows XP[®]/XP Embedded
 - Others: Linux, VxWorks, RTX VenturCom

Included Hardware/Software

- CompactPCI bus 5V, 3U
- Hardware plug and play
- AMD SC520
- 8 Mb SDRAM; 512 Kb Flash Memory
- 1 Digital Input + 1 Digital Output
- 1 PROFIBUS port, DB9 female, Galvanic insulation 500V
- Speed: 9.6 Kbps up to 12 Mbps

Compatible Protocols

- Master DP-V0 Class-1 and Class-2
- Master DP-V1 Class-1 and Class-2
- Slave DP-V0 (passive)

Conformance

- RoHS compliant
- CE
- OPC certified

Description	Engineering No.	Standard Order No.
CPCI-DPIO CompactPCI Network Interface Card for PROFIBUS-DP	DRL-DPM-CPI	112018-5004

*PROFIBUS is a trademark of PROFIBUS International

Brad® SST™
Network Interface Card
112014
PROFIBUS*-DP for High-Speed
PC-Based control



Features and Benefits

- High-speed deterministic communication for VME-Based control applications
- High-speed deterministic communication for PC-Based control applications
- OEM ready, hardware and software components provided separately
- On board FPGA eliminates data bottlenecks, ensuring delivery of time critical information
- Available with 1 or 2 PROFIBUS channels
- Typical application:
 - PC-Based control
 - Network diagnostics
 - Custom OEM system
 - Monitoring
 - Data storage

Description

- Highly customizable PROFIBUS access via Direct DPRAM services
 - Configuration
 - Diagnostic
 - Process Data
- Supports 16-bit transfers (VME D16) with both VME A24 (standard) and A16 (short IO) address transfers
- Redundancy feature; 2 channels version VME interface card provides the option of connecting to one or two independent PROFIBUS networks
- Manage DP Master and Slave modes simultaneously
- Auto-Boot (Configuration stored in Flash)
- Engineering Tools:
 - Configuration console (optional)
 - Test and diagnostic tools (optional)
- Supported OS: Open, documented memory map interface with C source code samples and library for custom driver development

Included Hardware/Software

- VME Bus, 6U double-eight
- 1 PROFIBUS port, DB9 female, Galvanic insulation 1000V
- Speed: 9.6 Kbps up to 12 Mbps
- LEDs for system status and communications status

Compatible Protocols

- Master DP-V0 Class-1 and Class-2
- Master DP-V1 Class-1 and Class-2
- Slave DP-V0
- FDL Send/Receive

Conformance

- RoHS compliant
- CE

Description	Engineering No.	Standard Order No.
VME Network Interface Card for PROFIBUS-DP, 1 Channel	SST-PB3-VME-1	112014-0004
VME Network Interface Card for PROFIBUS-DP, 2 Channels	SST-PB3-VME-2	112014-0006
PROFIBUS Configuration and Diagnostic Console, Single license with Parallel key	SST-PB3-CNF-P	112030-0008
PROFIBUS Configuration and Diagnostic Console, Single license with USB key	SST-PB3-CNF-U	112030-0009

*PROFIBUS is a trademark of PROFIBUS International

Brad® SST™ Communication Module for Rockwell SLC 500

112016
PROFIBUS*-DP Master/Slave



Features and Benefits

- Connects your Allen-Bradley SLC 500 to a PROFIBUS network
- Target markets: Factory automation, Process control, Complex machines, etc
- Direct IO Mapping, no Ladder Logic to write for configuration and data transfer between module and SLC processor

Description

High speed deterministic communication

- Fast, easy set up into SLC backplane; PROFIBUS IO data is automatically mapped into the SLC processor's I, O, MO and MI files
- Easy diagnostics: Built-in LEDs
- Manage DP Master and Slave modes simultaneously
- Auto-Boot (Configuration stored in Flash)
- Engineering Tools:
 - Configuration console
 - Test and diagnostic tools

Included Hardware/Software

- Acts as 1756 Input/Output module
- Support multiple modules in a chassis
- 1 PROFIBUS port, DB9 female, Galvanic insulation 1000V
- Speed: 9.6 Kbps up to 12 Mbps
- IO Mapping:
 - I and O Files—32 words in, 32 words out
 - M1 and M0 Files—1000 words in/out
- 1 serial port for configuration and diagnostic
- Firmware upgradeable

Compatible Protocols

- Master DP-V0 Class-1 and Class-2
- Master DP-V1 Class-1 and Class-2
- Slave DP-V0
- FDL Send/Receive

Conformance

- RoHS compliant
- CE
- Rockwell Encompass™

Description	Engineering No.	Standard Order No.
PROFIBUS Communication module for Rockwell SLC 500	SST-PB3-SLC	112016-0022

*PROFIBUS is a trademark of PROFIBUS International

Brad® SST™ Communication Module for Rockwell ControlLogix

112016
PROFIBUS*-DP Master/Slave



Features and Benefits

- Connects your Allen-Bradley® ControlLogix to a PROFIBUS network
- Target markets: Factory automation, Process control, Complex machines, etc.
- Fully integrated into the Rockwell Automation environment
- Remote configuration and monitoring via Rockwell RSLinx™ Add-On-Profile for Rockwell RSLogix5000
- Direct IO Mapping, no Ladder Logic to write for configuration and data transfer between module and CLX processor
- Conformal coating version:
 - Provide environmental and mechanical protection to significantly extend the life of the components and circuitry
 - Protect electronic boards from moisture and contaminants
- Typical applications:
 - Marine
 - Agro-Food
 - Mining
 - Harsh automotive, etc.

Description

- High-speed deterministic communication
- Easy diagnostics: Built-in LEDs and 4 characters display
- Manage DP Master and Slave modes simultaneously
- Allow to change PROFIBUS configuration with PLC in RUN mode
- Dynamically add/remove PROFIBUS slaves from the scan list
- CommDTM driver for FDT Frame engineering software (PACTware™, FieldCare™, FieldMate™, etc)
- Auto-Boot (Configuration stored in Flash)
- Engineering Tools:
 - Configuration console
 - Test and diagnostic tools

Included Hardware/Software

- Acts as Input/Output module
- Support multiple modules in a chassis; support Local and Remote chassis
- One PROFIBUS port, DB9 female, Galvanic insulation 1000V
- Speed: 9.6 Kbps up to 12 Mbps
- LEDs for system, communication, and network status
- Up to 1984 Input Bytes and 1968 Output Bytes
- One Serial port for configuration and diagnostic
- Firmware upgradeable

Compatible Protocols

- Master DP-V0 Class-1 and Class-2
- Master DP-V1 Class-1 and Class-2
- Slave DP-V0

Conformance

- RoHS compliant
- CE
- UL
- cUL
- Class 1 Div 2
- Rockwell Enccompass
- FDT Certified

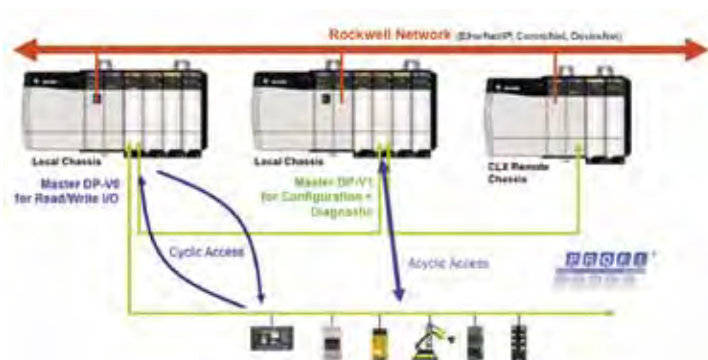

Description	Engineering No.	Standard Order No
PROFIBUS Communication module for Rockwell ControlLogix	SST-PB3-CLX-RLL	112016-0018
PROFIBUS Communication module for Rockwell ControlLogix, Conformal Coating version	SST-PB3-CLX-RLL-CC	112016-0023

*PROFIBUS is a trademark of PROFIBUS International

Brad® Direct-Link® Industrial Gateway

112034
PROFIBUS* to Serial



Features and Benefits

- Connects PROFIBUS controller to Master/Slave Serial devices
- Quick and cost effective solution
- Serial free send/receive; allow user to implement custom protocol (bar code reader, scale, operator display, etc)
- Typical uses:
 - Connecting Serial devices to PROFIBUS networks
 - Integration of legacy devices such as in the machine tool industry
 - Well suited for simple network extensions

Description

- Easy-to-use configuration by GSD file (no configuration tool needed)
- Automatic reconfiguration after replacement by the PROFIBUS Master (Set_Param command)
- Rotary switches for PROFIBUS Address
- Full diagnostic through LEDs, dedicated RS232 port and PROFIBUS Slave_Diag information

Included Hardware/Software

- IP20
- DIN rail mounting
- Up to 244 Input bytes and 244 Output bytes on PROFIBUS
- Up to 20 Modbus Read and Write commands with Cyclic, Change of State or trigger working modes
- Communication Ports
 - 1x Serial, 600 bps up to 57.6 Kbps, RS232/RS485
 - 1x PROFIBUS, 9.6 Kbps up to 12 Mbps, DB9 female

Compatible Protocols

- PROFIBUS
 - DP-VO Slave
- Serial
 - Modbus Master (ASCII/RTU)
 - Modbus Slave (ASCII/RTU)
 - Free Send/Receive Master/Slave

Conformance

- RoHS compliant
- CE

Description	Engineering No.	Standard Order No.
Gateway PROFIBUS-DP slave to Serial Master/Slave, RS232/485	DRL-DPS-SRM	112026-0013

*PROFIBUS is a trademark of PROFIBUS International

Brad® HarshIO 600

112038

Digital IP67 I/O Module Classic Format



Features and Benefits

- Reliable solution for connecting industrial controllers to IO devices in harsh duty environments
- Accepts M12 threaded connectors or Brad Ultra-Lock® Push-Pull connection system
- Standard hole housing pattern allows for interchangeability with popular IO modules
- Visible LEDs provide maintenance personnel with the ability to easily determine IO, module and network status

Description

- Rated IP67 for harsh environments
- Designed for direct machine mount applications
- 16 digital input/output per module
- Supports PNP and NPN input devices
- Watchdog with output reply state

Compatible Protocols

PROFIBUS Slave DP-V0

Conformance

- IP67 according to IEC 60529
- Vibration: IEC 60068-2-6 conformance
- Mechanical Shock: 10G, 11ms, 3 axis
- CE
- UL
- cUL
- RoHS compliant
- PNO certified

Included Hardware/Software

- IO Configurations:
 - 16 inputs
 - 14 inputs + 2 outputs
 - 12 inputs + 4 outputs
 - 8 inputs + 8 outputs
 - 8 inputs + 8 universal (inputs or outputs)
- IO Connectors: 8x M12 ports, Ultra-Lock M12 female 5-pole, internally threaded
- PROFIBUS Connectors:
 - 1x M12 male, 5-pole B-coded
 - 1x Ultra-Lock® M12 female, 5-pole B-coded
- Power Connectors:
 - Power In: Male Mini-Change, 5-pole
 - Power Out: Female Mini-Change, 5-pole
- Power Requirements:
 - Module input power: 24V DC
 - Module output power: 24V DC, 2.0A max per channel, 8.0A max per module
- Input Type:
 - Compatible with dry contact and PNP or NPN 3-wire switches
 - Electronic short circuit protection
- PROFIBUS Address: 1 to 99 by rotary switches or 1 to 125 by Set_Slave_Address command
- Input Delay: 0.5ms default or configurable (through GSD)
- Input Device Supply: 140mA per port at 25° C
- Output Load Current: 2.0A max per channel, electronic short circuit protection
- Maximum Switching Frequency: 200 Hz
- Housing Dimensions: 60.00 by 220.00 by 20.00mm (2.36 by 8.66 by .78")
- Mounting Dimensions:
 - 37.50mm (1.480") horizontal on centers
 - 210.00mm (8.270") vertical on centers
 - Center hole
- Operating Temperature: -25 to +70° C
- Storage Temperature: -40 to +85° C

No. of Power Pin	IO Configuration		Input Channel Type	Engineering No.	Standard Order No.
	Input	Output			
5	16		NPN	TCDPB-8DON-B1U	112038-0030
	14	2	NPN	TCDPB-8C2N-B1U	112038-0028
	12	4	NPN	TCDPB-8B4N-B1U	112038-0026
	8	8	NPN	TCDPB-888N-B1U	112038-0024
	16		PNP	TCDPB-8DOP-B1U	112038-0031
	14	2	PNP	TCDPB-8C2P-B1U	112038-0029
	12	4	PNP	TCDPB-8B4P-B1U	112038-0027
	8	8	PNP	TCDPB-888P-B1U	112038-0025

Brad® HarshIO 600

112038

Digital IP67 IO Module Compact Format



Features and Benefits

- Reliable solution for connecting industrial controllers to IO devices in harsh duty environments.
- Accepts M12 threaded connectors or Brad Ultra-Lock® Push-Pull connection system
- Visible LEDs provide maintenance personnel with the ability to easily determine IO, module and network status

Description

- Rated IP67 for harsh environments
- Designed for direct machine mount applications
- Eight digital input/output per module
- Supports PNP and NPN input devices
- Watchdog with output reply state

Compatible Protocols

PROFIBUS Slave DP-VO

Conformance

- IP67 according to IEC 60529
- Vibration: IEC 60068-2-6 conformance
- Mechanical Shock: 10G, 11ms, 3 axis
- CE
- UL
- cUL
- RoHS compliant
- PNO certified

Included Hardware/Software

- IO Configurations:
 - 8 inputs
 - 6 inputs + 2 outputs
 - 4 inputs + 4 outputs
 - 8 outputs
- IO Connectors:
 - 4x ports, Ultra-Lock® M12 female 5-pole, internally threaded
 - 8x ports, M8 female 3-pole threaded
- PROFIBUS Connectors:
 - 1x M12 male, 5-pole, B-coding
 - 1x Ultra-Lock® M12 female, 5-pole, B-coding
- Power Connectors: M12 male, 5-pole, A-coding
- Power Requirements:
 - Module Input Power—24V DC
 - Module Output Power—24V DC, 4.0A max.
- Input Type:
 - Compatible with dry contact and PNP or NPN
 - Electronic short circuit protection
- PROFIBUS Address: 1 to 99 by rotary switches or 1 to 125 by Set_Slave_Address command
- Input Delay: 3ms default or configurable (through GSD)
- Input Device Supply: 140mA per port at 25° C
- Output Load Current: 1.4A max. per channel, electronic short circuit protection
- Maximum Switching Frequency: 200 Hz
- Housing Dimensions: 30.00 by 175 by 20.00mm (1.18 by 6.89 by .78")
- Mounting Dimensions:
 - 23.00mm (0.91") horizontal on centers
 - 168.00mm (6.61") vertical on centers
- Operating Temperature: -25 to +70° C
- Storage Temperature: -40 to +85° C

Compact—M8

No. of Power Pin	IO Configuration		Input Channel Type	Engineering No.	Standard Order No.
	Input	Output			
5	8		NPN	TBDPB-880N-B84	112038-0019
	6	2	NPN	TBDPB-862N-B84	112038-0017
	4	4	NPN	TBDPB-844N-B84	112038-0015
	8		PNP	TBDPB-880P-B84	112038-0021
	6	2	PNP	TBDPB-862P-B84	112038-0018
	4	4	PNP	TBDPB-844P-B84	112038-0016
		8	PNP	TBDPB-808P-B84	112038-0014

Compact—M12

No. of Power Pin	IO Configuration		Input Channel Type	Engineering No.	Standard Order No.
	Input	Output			
5	8		NPN	TBDPB-480N-B8U	112038-0009
	6	2	NPN	TBDPB-462N-B8U	112038-0007
	4	4	NPN	TBDPB-444N-B8U	112038-0005
	8		PNP	TBDPB-480P-B8U	112038-0011
	6	2	PNP	TBDPB-462P-B8U	112038-0008
	4	4	PNP	TBDPB-444P-B8U	112038-0006
		8	PNP	TBDPB-408P-B8U	112038-0003

PROFIBUS* Brad® Solid Core Bulk Cables

130211



Features and Benefits

- Provides field installation flexibility
- Used with field-attachables to provide plug-and-play solution

Overall

Voltage Rating: 300V
 Operating Temperature: -40 to +60° C
 Maximum O.D.: 0.331" (8.40 mm)

Construction

Jacket Material: PUR
 Inner Material Insulation: Polyethylene
 Shield Type: Aluminum Foil 100%
 Tinned Copper braid 80%
 Conductors: Twisted Pair 22 AWG solid wire

Electrical

DC Resistance: 186 W/K Ohms
 Nominal Impedance: 150 ± 15 OHMS
 Effective Capacitance (1 KHz): 28.5 nF/KW
 Approvals: UL, CSA

Cable Flex Information

Torsion:
 Survived more than 2 million cycles at 360° over 1.0m
 C-Track: Survived more than 3 million cycles at
 acceleration to 10.0m/s² and process speed of
 5.0m/s
 Bend Radius: 10 X cable diameter

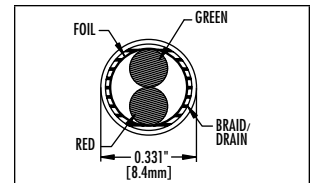

Cable Length	Max. Current	Max. Voltage	Cable Type	Cable Jacket	Wire Size	Engineering No.	Standard Order No.
76.2m (250')	4.0A	300V	Twisted Pair	PUR	22	85-0001	130211-0032

Note: Sales drawings for all standard order numbers are available on molex.com
 *PROFIBUS is a trademark of PROFIBUS International

PROFIBUS* Brad® Micro-Change® (M12) Single-Ended Cordsets

120039/120098

Female
Straight, Right Angle
Threaded



Features and Benefits

- PUR jacketed for chemical and oil resistance
- Low-resistance contact design
- Leaded end allows for easy field termination
- 360° shielded head design to reduce RFI/EMI

Physical

Connector Face: Nylon 6/6
Molded Body: PUR
O-Ring: Nitrile rubber
Coupling Nut: Nickel-plated Brass (360° shielded)
Operating Temperature: -20 to +80° C

Environmental

Protection: IP67
NEMA Rating: NEMA 6

Cable

Outside Diameter: 8 ± 0.20mm

Cable Construction

Jacket Material: PUR
Inner Material Insulation: PE insulation
Shield Type: PETP/AV foil, Tinned Copper braid 65%
Conductor: Twisted pair 22 AWG

Cable Flex Information

Torsion: Survived more than 2 million cycles at 360° over 1.0m
C-Track: More than 3 million cycles at acceleration 10.0m/s² and process speed of 5.0m/s
Bend Radius: 7.5 x cable diameter (static)

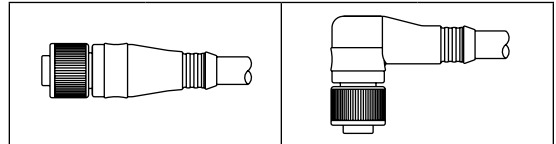

Poles (Female View)	Max. Current per Contact	Max. Voltage	Cable Type	Cable Jacket	Wire Size AWG	Length	Straight		Right Angle	
							Engineering No.	Standard Order No.	Engineering No.	Standard Order No.
<p>5 Pole 1 - Not used 2 - Green (Bus A) 3 - Not used 4 - Red (Bus B) 5 - Shield</p>	4.0A	250V AC/DC	Twisted Pair	PUR	22	1.0m	B05500PP4M010	120098-0084	B05501PP4M010	120039-0132

Note: Sales drawings for all standard order numbers are available on molex.com
*PROFIBUS is a trademark of PROFIBUS International

Configuration Code†
Build-a-Part Number

	Length	Code
Meters	2	M020
	5	M050
	10	M100

B05S01PP4M010

†Once an engineering number is created using the configuration code, consult Molex tech support for information regarding any part numbers.

PROFIBUS* Brad® Micro-Change® (M12) Single-Ended Cordsets

120039/120098

Male
Straight, Right Angle
Threaded



Features and Benefits

- PUR jacketed for chemical and oil resistance
- Low-resistance contact design
- Leaded end allows for easy field termination
- 360° shielded head design to reduce RFI/EMI

Physical

Connector Face: Nylon 6/6
Molded Body: PUR
O-Ring: Nitrile Rubber
Coupling Nut: Nickel-plated Brass (360° shielded)
Operating Temperature: -20 to +80° C

Environmental

Protection: IP67
NEMA Rating: NEMA 6

Cable

Outside Diameter: 8.00 ± 0.20mm

Cable Construction

Jacket Material: PUR
Inner Material Insulation: PE insulation
Shield Type: PETP/AV foil, Tinned Copper braid 65%
Conductor: Twisted pair 22 AWG

Cable Flex Information

Torsion: Survived more than 2 million cycles at 360° over 1.0m
C-Track: Survived more than 3 million cycles at acceleration 10.0m/s² and process speed of 5.0m/s
Bend Radius: 7.5 x cable diameter (static)

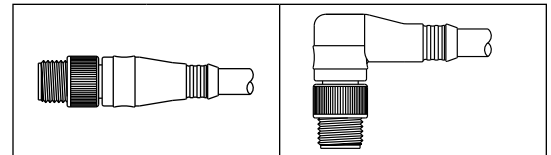

Poles	Max. Current per Contact	Max. Voltage	Cable Type	Cable Jacket	Wire Size AWG	Length	Straight		Right Angle	
							Engineering No.	Standard Order No.	Engineering No.	Standard Order No.
<p>5 Pole</p> <p>1 - Not used 4 - Red (Bus B)</p> <p>2 - Green (Bus A) 5 - Shield</p> <p>3 - Not used</p>	4.0A	250V AC/DC	Twisted Pair	PUR	22	1.0m	B05S07PP4M010	120039-0158	B05S06PP4M010	120098-0099

Note: Sales drawings for all standard order numbers are available on molex.com
*PROFIBUS is a trademark of PROFIBUS International

Configuration Code†
Build-a-Part Number

	Length	Code
Meters	1	M010
	2	M020
	5	M050
	10	M100

B05S01PP4M010

†Once an engineering number is created using the configuration code, consult Molex tech support for information regarding any part numbers.

PROFIBUS* Brad® Micro-Change® (M12) Double-Ended Cordsets

120098

**Female, Male
Straight-to-Straight
Straight-to-Right Angle
Right Angle-to-Right Angle
Right Angle-to-Straight
Threaded**



Features and Benefits

- PUR jacketed for chemical and oil resistance
- Low-resistance contact design for repeated mating
- Provides a plug-and-play solution for quick field installation
- 360° shielded head design to reduce RFI/EMI

Mechanical

Connector Face: Nylon 6/6
Molded Body: PUR
Coupling Nut: Nickel-plated Brass (360° shielded)

Physical

Operating Temperature: -20 to +80° C

Environmental

Protection: IP67
NEMA Rating: NEMA 6

Cable

Outside Diameter: 8.00 ± 0.20mm

Cable Construction

Cable Type: Twisted pair
Cable Jacket: PUR
Jacket Material: PUR
Inner Material Insulation: PE insulation
Shield Type: PETP/AV foil, Tinned Copper braid 65%
Conductor: Twisted pair 22 AWG

Cable Flex Information

Torsion: Survived more than 2 million cycles at 360° over 1.0m
C-Track: Survived more than 3 million cycles at acceleration of 10.0m/s² and process speed of 5.0m/s
Bend Radius: 7.5 x cable diameter (static)

Pole (Female View)	Max. Current per Contact	Max. Voltage	Wire Size AWG	Length	Straight-to-Straight		Straight-to-Right Angle		Right Angle-to-Right Angle		Right Angle-to-Straight	
					Engineering No.	Standard Order No.	Engineering No.	Standard Order No.	Engineering No.	Standard Order No.	Engineering No.	Standard Order No.
<p>5 Pole 1 - Not used 2 - Green (Bus A) 3 - Not used 4 - Red (Bus B) 5 - Shield</p>	4.0A	250V AC/DC	22	1.0m	BB5S30PP4M010	120098-0006	BB5S31PP4M010	120098-5021	BB5S33PP4M010	120098-0029	BB5S32PP4M010	120098-0024

Note: Sales drawings for all standard order numbers are available on molex.com

*PROFIBUS is a trademark of PROFIBUS International

Configuration Code[†]
Build-a-Part Number

Length	Code
1	M010
2	M020
5	M050
10	M100

BB5S30PP4M010

[†]Once an engineering number is created using the configuration code, consult Molex tech support for information regarding any part numbers.

PROFIBUS* Brad® Micro-Change® (M12) Single-Ended Data Line Receptacles

120099

**Female, Male
Back Panel Mount
Cable**



Features and Benefits

- Epoxy potted for durability
- Provides a quick disconnect solution to control panels
- Enables plug-and-play to junction boxes

Physical

Shell: Nickel-plated Brass
Insert: Nylon 6/6
O-Ring: Nitrile Rubber
Operating Temperature: -20 to +80° C

Environmental

Protection: IP67
NEMA Rating: NEMA 6

Cable Construction

Jacket Material: PUR
Inner Material Insulation: PE insulation
Shield Type: Petp/Av Foil, Tinned Copper braid 65%
Conductor: Twisted pair 22 AWG

Cable Flex Information

Torsion: Survived more than 2 million cycles at 360° over 1.0m
C-Track: Survived more than 3 million cycles at acceleration of 10.0m/s² and process speed up to 5.0m/s
Bend Radius: 7.5 x cable diameter (static)

Cable

Outside Diameter: 8.00 ± 0.20mm

							Configuration			
							Female M16 x 1.5 Mounting Thread Back Panel Mount		Male M16 x 1.5 Mounting Thread Back Panel Mount	
Poles	Max. Current per Contact	Max. Voltage	Cable Type	Cable Jacket (Cable Code)	Wire Size AWG	Length	Engineering No.	Standard Order No.	Engineering No.	Standard Order No.
5 Pole Female 1 - Not used 4 - Red (Bus B) 2 - Green (Bus A) 5 - Shield 3 - Not used	4.0A	250V AC/DC	Twisted Pair	PUR	22	1.0m	BR5U70PP4M0103	120099-0005		
5 Pole Male 1 - Not used 4 - Red (Bus B) 2 - Green (Bus A) 5 - Shield 3 - Not used									BR5U76PP4M0103	120099-0013

Note: Sales drawings for all standard order numbers are available on molex.com
*PROFIBUS is a trademark of PROFIBUS International

Configuration Code†
Build-a-Part Number

	Length	Code
Meters	0.3	M003
	1	M010
	2	M020

BR5U70PP4M010

†Once an engineering number is created using the configuration code, consult Molex tech support for information regarding any part numbers.

PROFIBUS* Brad® Micro-Change® (M12) Data Line Receptacles

120099

Female, Male
Front Panel Mount
Wire Leads



Features and Benefits

- Epoxy potted for industrial environments
- Used in control panels and junction boxes
- Used to feed through panels
- Can be used with Siemens™ ET 200 I/O block to provide a quick disconnect solution

Physical

Shell: Nickel-plated Brass
Insert: Nylon 6/6
O-Ring: Nitrile rubber
Operating Temperature: -20 to +80° C

Environmental

Protection: IP67
NEMA Rating: NEMA 6

Configuration	Female, PG11 Mounting Thread, Front Panel Mount		Male, PG11 Mounting Thread, Front Panel Mount	
	Wire Type	PVC Leads	Wire Type	PVC Leads
Wire Size AWG	22	22	22	22
Length	3"	3"	3"	3"

Poles	Max. Current per Contact	Max. Voltage	Engineering No.	Standard Order No.	Engineering No.	Standard Order No.
5 Pole Female 1 - Not used 4 - Red (Bus B) 2 - Green (Bus A) 5 - Shield 3 - Not used	4.0A	250V AC/DC	81689-030	120099-0024		
5 Pole Male 1 - Not used 4 - Red (Bus B) 2 - Green (Bus A) 5 - Shield 3 - Not used	4.0A	250V AC/DC			81688-030	120099-0025

Note: Sales drawings for all standard order numbers are available on molex.com
*PROFIBUS is a trademark of PROFIBUS International

PROFIBUS* Brad® Micro-Change® (M12) Data Line Bulkhead Pass-Through Receptacle

120099

Female Straight-to-Male Straight
Front Panel Mount



Features and Benefits

- Epoxy potted for industrial environments
- Used in control panels and junction boxes
- Used to feed through panels
- Can be used with Siemens™ ET 200 I/O block to provide a quick disconnect solution

Physical

Shell: Nickel-plated Brass
 Insert: Nylon 6/6
 Conductors: Bulkhead Feed-Through—Solid phosphor Bronze
 O-Ring: Nitrile rubber
 Operating Temperature: -20 to +80° C

Environmental

Protection: IP67
 NEMA Rating: NEMA 6



Poles	Max. Current per Contact	Max. Voltage	Mounting	Female Straight-to-Male Straight M12 Mounting Thread	
				Engineering No.	Standard Order No.
<p>5 Pole Female</p> <p>1 - Not used 4 - Red (Bus B) 2 - Green (Bus A) 5 - Shield 3 - Not used</p> <p>Male</p> <p>1 - Not used 4 - Red 2 - Green 5 - Gray 3 - Not used</p>	4.0A	250V AC/DC	Front Panel Mount	BR5L30	120099-0001

Note: Sales drawings for all standard order numbers are available on molex.com
 *PROFIBUS is a trademark of PROFIBUS International

PROFIBUS* Brad® Micro-Change® (M12) Field Attachable Connectors

120100
Female, Male
Straight
Threaded



Features and Benefits

- Screw terminal connection for 22 AWG conductors
- Easy field installation of quick-disconnect design
- For use with all reverse keyway M12 designs
- Shielded to reduce RFI/EMI

Physical

Connector Face: Polyamide
Body: Nickel-plated Brass
Contact: Silver-plated Brass
Coupling Nut: Nickel-plated Brass
Grommet: Nitrile rubber
Conductor Size: 22 AWG
Operating Temperature: -25 to +90° C

Environmental

Protection: IP67

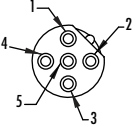
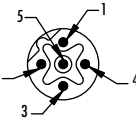
Poles	Max. Current per Contact	Max. Voltage	Cable Diameter Range	Female Straight		Male Straight	
				Engineering No.	Standard Order No.	Engineering No.	Standard Order No.
 <p>5 Pole Female</p> <p>1 - Not used 4 - Red (Bus B) 2 - Green (Bus A) 5 - Shield 3 - Not used</p>	4.0A	250V AC/DC	4.10 - 8.10mm	BA5500-32	120100-0001		
 <p>5 Pole Male</p> <p>1 - Not used 4 - Red (Bus B) 2 - Green (Bus A) 5 - Shield 3 - Not used</p>				BA5506-32	120100-0002		

Note: Sales drawings for all standard order numbers are available on molex.com
*PROFIBUS is a trademark of PROFIBUS International

PROFIBUS* Brad® Micro-Change® (M12) Bus Terminators

120102
Male
Straight
External Thread



Features and Benefits

- Shielded to reduce RFI/EMI and improve signal integrity
- Male reverse key Brad Micro-Change terminator
- M12 threads
- Used with remote active I/O modules
- Used to terminate end of data line

Electrical

Voltage: 250V AC/DC
Current: 4.0A

Physical

Connector Face: Nylon 6/6
Molded Body: PVC
O-Ring: Terminators—Nitrile rubber
Coupling Nuts: Nickel-plated Brass

Environmental

Protection: IP67

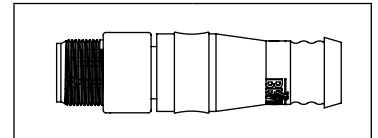

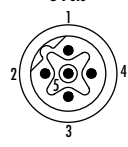
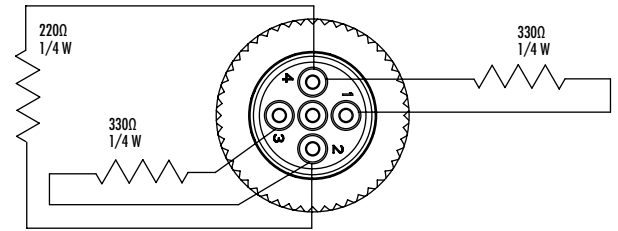
Poles (Male View)	Wiring Schematic	Engineering No.	Standard Order No.
<p>5 Pole (Male View)</p>  <p>1 - 5V DC 4 - Bus-B 2 - Bus-A 5 - Shield 3 - Ground</p>		<p>B05506</p>	<p>120102-0002</p>

Note: Sales drawings for all standard order numbers are available on molex.com
*PROFIBUS is a trademark of PROFIBUS International

PROFIBUS* Brad® Micro-Change® (M12) Data Line Tees

120101



Features and Benefits

- Shielded to reduce RFI/EMI and improve signal integrity
- M12 threads
- Provides quick disconnection of bus line
- Allows disconnection of node without shutting down the network
- Used with remote active I/O modules

Electrical

Voltage: 30V AC/36V DC
Current: 4.0A

Physical

Connector Face: Nylon 6/6
Molded Body: PVC
O-Ring: Viton®
Coupling Nuts: Nickel-plated Brass
Shielding Sleeves: Nickel-plated Brass

Environmental

Protection: IP67

General

Coupling nuts, pin 5 and PCB all connected to provide full shielding; Reverse key for PROFIBUS circuitry includes line balancing inductors

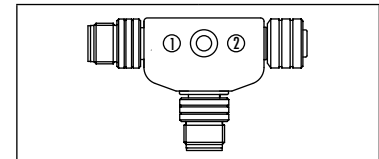

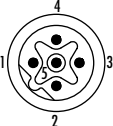
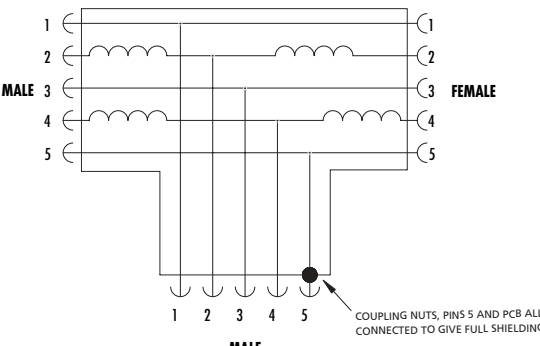
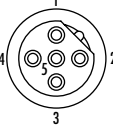
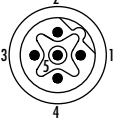
Poles	Wiring Schematic	Engineering No.	Standard Order No.
<p>5 Pole 4 1 3 2 Bus In Male Face View</p> 		PDT501	120101-0002
<p>5 Pole 1 4 2 3 Bus Out Female Face View</p> 			
<p>5 Pole 2 3 1 4 Drop Bus Male Face View</p> 			

Note: Sales drawings for all standard order numbers are available on molex.com
*PROFIBUS is a trademark of PROFIBUS International

Recommended Use of Drop Lines

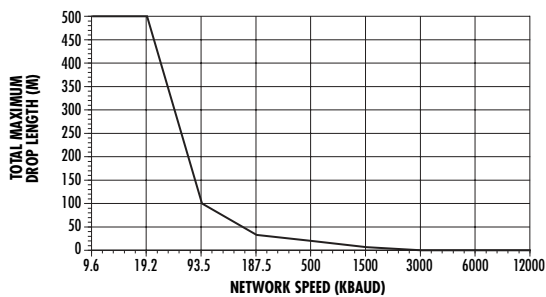

PROFIBUS* Brad® D-Sub Field Attachable Connectors

120100/120103

9-pin D-Sub
Plastic Housing
Metal Housing
Diagnostic



Features and Benefits

- All metal construction for harsh environments
- Fully shielded for high noise immunity
- IDC connections for fast and reliable installations
- Captive single-screw mechanism—no loose parts
- High transfer rate—12 MBaud
- 4 LEDs for fast diagnostics and health status of the bus and device (diagnostic versions only)
- Terminator monitor indicates if terminator is missing (diagnostics versions only)
- Integrated switchable terminators
- Transparent cable slots and covers for high visibility
- Integrated programming/diagnostic port (on 90°/45° formats)
- Available in 0°, 45° and 90° formats making connections to various devices easier

Mechanical

PROFIBUS: 9-pole SubD pin headers
 Programming/Diagnostics: 9-pole SubD socket
 Insertion (withdrawal) Cycles: min. 200
 Cable Type: Solid core PROFIBUS Type A, EN50170
 Cable Diameter: 8.00mm
 Screw/Tightening Torque: 4-40 UNC/0.4Nm
 Enclosure Material: Die-cast Zinc
 Temperature Range: -20 to +75° C
 Cable Connection: IDC technology
 Terminating Resistor: Build-in switchable
 Bus Signals: Dual, in and out

Insulation Stripping Lengths

Outer Sheath: 17.00mm
 Shield: 11.00mm

9 Pin D-Sub Plastic Housing Field Attachable

Face View	Housing Material	Termination Switch	Programming Port	Diagnostic LEDs	Configuration (D-Sub)			
					0 or Right Degree Angle		Right Angle	
					Engineering No.	Standard Order No.	Engineering No.	Standard Order No.
<p>1 - Not used 6 - Not used 2 - Not used 7 - Not used 3 - Red (Bus B) 8 - Green (Bus A) 4 - Not used 9 - Not used 5 - Not used</p>	ABS	Yes	No	No	MA9D00-32	120100-0004		
			Yes	No			MA9DP0-32	120100-0003

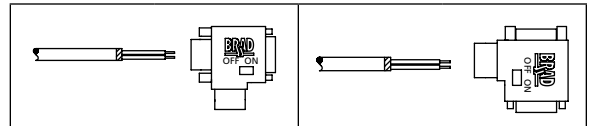

9 Pin D-Sub Metal Housing Diagnostic Field Attachable

Face View	Housing Material	Termination Switch	Programming/Diagnostics Port	Diagnostic LEDs	Cable Connection	Configuration (D-Sub)					
						0 Degree Angle		45 Degree Angle		Right Angle	
						Engineering No.	Standard Order No.	Engineering No.	Standard Order No.	Engineering No.	Standard Order No.
<p>1 - Not used 6 - Not used 2 - Not used 7 - Not used 3 - Red (Bus B) 8 - Green (Bus A) 4 - Not used 9 - Not used 5 - Not used</p>	Die-cast Zinc	Yes	No	Yes	IDC Technology	MA9D00-42	120103-5001				
			Yes				PA9D0B-42	120103-0003			
			Yes						PA9D01-42	120103-0001	
			No			No			PA9S01-42	120103-0005	

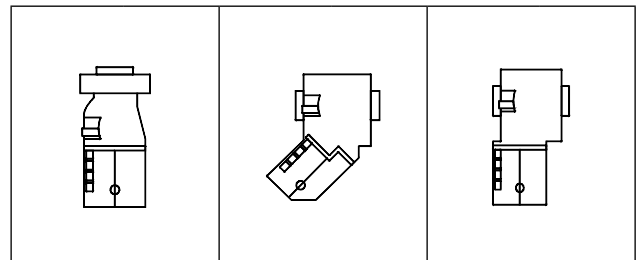

LED	Color	LED Off	LED On	LED Flashing at 5Hz
PWR	Yellow	No 5 Vdc Power Supply from Device	Self Testing Completed Device Power OK	PB Master Failed or Short Circuit of Wire
TxD	Green	No Bus Activity	N/A	Data Transfer in Progress
Term	Yellow	No Termination	Terminator OK	Internal Terminating Resistors Faulty
ERR	Red	No Errors	Faulty Bus Terminations in the Bus Line	Signal Levels Out of Defined Range

*PROFIBUS is a trademark of PROFIBUS International

PROFIBUS* Brad® D-Sub Single-Ended Cordsets

120098

Male

Horizontal, Vertical,
Vertical with Programming Port



Features and Benefits

- PUR jacketed for chemical and oil resistance
- D-Sub connector enables interface card connection
- D-Sub connector provides termination circuitry
- D-Sub includes termination switch for field installation flexibility

Mechanical

Material: ABS

Physical

Operating Temperature: 0 to 60° C

Environmental

Protection: IP40

Cable

Outside Diameter: 8.00 ±2.00mm

Cable Construction

Jacket Material: PUR

Inner Material Insulation: PE insulation

Shield Type: PETP/AV foil, Tinned Copper braid 65%

Conductor: Twisted pair 22 AWG

Cable Flex Information

Torsion: Survived more than 2 million cycles at 360° over 1.0m

C-Track: Survived more than 3 million cycles at acceleration of 10.0m/s² and process speed of 5.0m/s

Bend Radius: 7.5 x cable diameter (static)

Face View (Male)	Max. Current per Contact	Max. Voltage	Cable Type	Cable Jacket	Wire Size AWG	Length	Horizontal		Vertical		Vertical with Programming Port	
							Engineering No.	Standard Order No.	Engineering No.	Standard Order No.	Engineering No.	Standard Order No.
<p>1 - Not used 6 - Not used 2 - Not used 7 - Not used 3 - Red (Bus-B) 8 - Green (Bus-B) 4 - Not used 9 - Not used 5 - Not used</p>	4.0A	250V AC/DC	Twisted Pair	PUR	22	1.0m	M03S06PP4M010	120098-0202	M03S07PP4M010	120098-8025	P03S07PP4M010	120098-0203

Note: Sales drawings for all standard order numbers are available on molex.com

*Profibus is a trademark of Profibus International

Configuration Code†
Build-a-Part Number

	Length	Code
Meters	1	M010
	2	M020
	5	M050
	10	M100

M03S62PP4M010

†Once an engineering number is created using the configuration code, consult Molex tech support for information regarding any part numbers.

PROFIBUS* Brad® D-Sub-to-D-Sub Double-Ended Cordsets

120098

Horizontal, Vertical
Vertical with Programming Port



Features and Benefits

- PUR jacketed for chemical and oil resistance
- D-Sub connector enables interface card connection
- D-Sub connector provides termination circuitry
- D-Sub includes termination switch for field installation flexibility

Mechanical

Material: ABS

Physical

Operating Temperature: 0 to 60° C

Environmental

Protection: IP40

Cable

Outside Diameter: 8.00 ± 0.20 mm

Cable Construction

Cable Type: Twisted pair

Cable Jacket: PUR

Wire Size: 22 AWG

Jacket Material: PUR

Inner Material Insulation: PE insulation

Shield Type: PETP/AV Foil, Tinned Copper braid 65%

Conductor: Twisted pair 22 AWG

Cable Flex Information

Torsion: Survived more than 2 million cycles at 360° over 1.0m

C-Track: Survived more than 3 million cycles at acceleration of 10.0m/s² and process speed of 5.0m/s

Bend Radius: 7.5 x cable diameter (static)

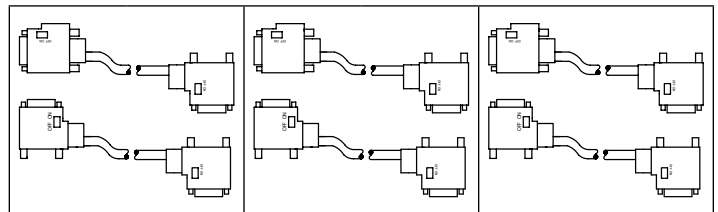

Face View (Male)	Max. Current per Contact	Max. Voltage	Length	Configuration (D-Sub)	Configuration (D-Sub)					
					Horizontal		Vertical		Vertical with Programming Port	
					Engineering No.	Standard Order No.	Engineering No.	Standard Order No.	Engineering No.	Standard Order No.
<p>1 - Not used 6 - Not used 2 - Not used 7 - Not used 3 - Red (Bus B) 8 - Green (Bus A) 4 - Not used 9 - Not used 5 - Not used</p>	4.0A	250V AC/DC	1.0m	Horizontal	MM3S60PP4M010	120098-0198	MM3S62PP4M010	120098-0200	MP3S62PP4M010	120098-0199
				Vertical	MM3S62PP4M010	120098-0200	MM3S63PP4M020	120098-0120	MP3S63PP4M020	120098-0122

Note: Sales drawings for all standard order numbers are available on molex.com

*PROFIBUS is a trademark of PROFIBUS International

Configuration Code†
Build-a-Part Number

	Length	Code
Meters	1	M010
	2	M020
	5	M050
	10	M100

MM3S60PP4M010

†Once an engineering number is created using the configuration code, consult Molex tech support for information regarding any part numbers.

PROFIBUS* Brad® D-Sub-to-(2) D-Sub Connectors Double-Ended Cordsets

120098

**Horizontal, Vertical
Vertical with Programming Ports**



Features and Benefits

- PUR jacketed for chemical and oil resistance
- D-Sub connector enables interface card connection
- D-Sub connector provides termination circuitry
- D-Sub includes termination switch for field installation flexibility

Mechanical

Material: ABS

Physical

Operating Temperature: 0 to 60° C

Environmental

Protection: IP40

Cable

Outside Diameter: 8.00 ± 0.20 mm

Cable Construction

Cable Type: Twisted pair

Cable Jacket: PUR

Wire Size: 22 AWG

Jacket Material: PUR

Inner Material Insulation: PE insulation

Shield Type: PETP/AV Foil, Tinned Copper braid 65%

Conductor: Twisted pair 22 AWG

Cable Flex Information

Torsion: Survived more than 2 million cycles at 360° over 1.0m

C-Track: Survived more than 3 million cycles at acceleration of 10.0m/s² and process speed of 5.0m/s

Bend Radius: 7.5 x cable diameter (static)

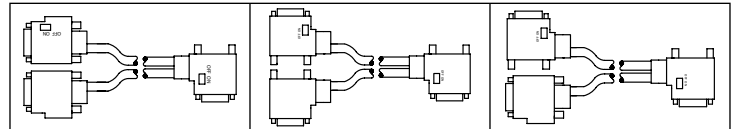

Face View (Male)	Max. Current per Contact	Max. Voltage	Length	Configuration (D-Sub)	Configuration (D-Sub)					
					Horizontal		Vertical		Vertical with Programming Port	
					Engineering No.	Standard Order No.	Engineering No.	Standard Order No.	Engineering No.	Standard Order No.
<p>1 - Not used 6 - Not used 2 - Not used 7 - Not used 3 - Red (Bus B) 8 - Green (Bus A) 4 - Not used 9 - Not used 5 - Not used</p>	4.0A	250V AC/DC	1.0m	(2) Horizontal	MM3G60PP4M010	120098-0204			MP3G62PP4M010	120098-0206
				(2) Vertical	MM3G61PP4M010	120098-0207			MP3G63PP4M010	120098-0209
				(1) Horizontal (1) Vertical	MM3G70PP4M010	120098-0211	MM3G72PP4M010	120098-8035	MP3G72PP4M010	120098-0213

Note: Sales drawings for all standard order numbers are available on molex.com

*PROFIBUS is a trademark of PROFIBUS International

Configuration Code†
Build-a-Part Number

	Length	Code
Meters	1	M010
	2	M020
	5	M050
	10	M100

MM3G60PP4M010

†Once an engineering number is created using the configuration code, consult Molex tech support for information regarding any part numbers.

PROFIBUS* Brad® Micro-Change® (M12)-to-D-Sub Double-Ended Cordsets

120098

**Micro-Change Male Straight/Right Angle-to-D-Sub
Micro-Change Female Straight/Right Angle-to-D-Sub
Threaded**



Features and Benefits

Double-Ended Cordset

- Double ended straight and 90°
- Used in a variety of configurations where a complete daisy-chain plug-and-play solution is desired

D-Sub Cordset

- Shielded D-Sub connector maintains signal integrity in noisy environments
- D-Sub includes termination switch for field installation flexibility
- Plug and play connection between PROFIBUS interface cards and modules
- D-Sub to single or dual-ended M12
- Horizontal, vertical, straight or 90° configurations
- Standard and application specific lengths

Physical

Brad Micro-Change Connector

Connector Face: Nylon 6/6
Molded Body: PUR
Coupling Nut: Nickel-plated Brass (360° Shielded)
Operating Temperature: -20 to +80° C

9-pin D-Sub Connector

Material: ABS
Operating Temperature: 0 to 60° C

Environmental

Brad Micro-Change Connector

Protection: IP67
NEMA Rating: NEMA 6
Operating Temperature: -20 to +80° C

9-pin D-Sub Connector

Protection: IP40
Operating Temperature: 0 to 60° C

Cable

Outside Diameter: 8.00 ± 0.20mm

Cable Construction

Cable Type: Twisted pair
Cable Jacket: PUR
Jacket Material: PUR
Inner Material Insulation: PE insulation
Shield Type: PETP/AV foil, Tinned Copper braid 65%
Conductor: Twisted pair 22 AWG

Cable Flex Information

Torsion: Survived more than 2 million cycles at 360° over 1.0m
C-Track: Survived more than 3 million cycles at acceleration of 10.0m/s² and process speed of 5.0m/s
Bend Radius: 7.5 x cable diameter (static)

Electrical

Voltage: 250V AC/DC max.
Current: 4.0A max.

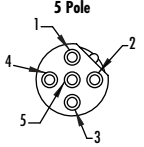
Pole (Female View)	Wire Size AWG	Length	Configuration (D-Sub)	Male Straight		Male Right Angle		Female Straight		Female Right Angle	
				Engineering No.	Standard Order No.	Engineering No.	Standard Order No.	Engineering No.	Standard Order No.	Engineering No.	Standard Order No.
 <p>5 Pole 1 - Not used 4 - Red 2 - Green (Bus B) 3 - Not used 5 - Shield 4 - Red 5 - Shield</p>	22	1.0m	Horizontal	BM5S60PP4M010	120098-0062	BM5S61PP4M010	120098-0223	BM5S30PP4M010	120098-0155	BM5S31PP4M010	120098-0184
			Vertical	BM5S62PP4M010	120098-0065	BM5S63PP4M010	120098-0070	BM5S32PP4M010	120098-0057	BM5S33PP4M010	120098-5007
			Vertical with Programming Port	BP5S62PP4M010	120098-0079	BP5S63PP4M010	120098-0181	BP5S32PP4M010	120098-0183	BP5S33PP4M010	120098-0077

Note: Sales drawings for all standard order numbers are available on molex.com
*PROFIBUS is a trademark of PROFIBUS International

Configuration Code†
Build-a-Part Number

	Length	Code
Meters	1	M010
	2	M020
	5	M050
	10	M100

BM5S60PP4M010

†Once an engineering number is created using the configuration code, consult Molex tech support for information regarding any part numbers.

PROFIBUS* Brad® Micro-Change® (M12)-to-D-Sub Double-Ended Cordsets

120098

- (2) Straight Male-to-Micro-Change
- (2) Male Right Angle-to-Micro-Change
- (2) Female Straight-to-Micro-Change
- (2) Female Right Angle-to-Micro-Change
- (1) Male Straight, (1) Female Straight Threaded



Features and Benefits

- PUR jacketed for chemical and oil resistance
- D-Sub connector enables interface card connection
- The shielded D-Sub connector maintains signal integrity in noisy environments
- 360° shielded Micro-change head design to reduce RFI/EMI
- D-Sub includes termination switch for field installation flexibility

Micro-Change Connector

Physical

Connector Face: Nylon 6/6
Molded Body: PUR
Coupling Nut: Nickel-plated Brass (360° Shielded)
Operating Temperature: -20 to +80° C

Environmental

Protection: IP67
NEMA Rating: NEMA 6

9-Pin D-Sub Connector

Electrical

Voltage Rating: 250V AC/DC

Mechanical

Material: ABS

Physical

Operating Temperature: 0 to 60° C

Environmental

Protection: IP40

Cable

Outside Diameter: 8.00 ±0.20mm

Cable Construction

Cable Type: Twisted pair
Cable Jacket: PUR
Wire Size: 22 AWG
Jacket Material: PUR
Inner Material Insulation: PE insulation
Shield Type: PETP/AV Foil, Tinned Copper braid 65%
Conductor: Twisted pair 22 AWG

Cable Flex Information

Torsion: Survived more than 2 million cycles at 360° over 1.0m
C-Track: Survived more than 3 million cycles at acceleration of 10.0m/s² and process speed of 5.0m/s
Bend Radius: 7.5 x cable diameter (static)

Face View (Male)	Max. Current per Contact	Max. Voltage	Configuration (D-Sub)	Micro-Change (M12) Connection					
				(2) Straight Male-to-Micro-Change		(2) Male Right Angle-to-Micro-Change		(2) Female Straight-to-Micro-Change	
				Engineering No.	Standard Order No.	Engineering No.	Standard Order No.	Engineering No.	Standard Order No.
	4.0A	250V AC/DC	Horizontal	BM5G60PP4M010	120098-0150	BM5G61PP4M010	120098-0151	BM5G30PP4M010	120098-0190
			Vertical	BM5G62PP4M010	120098-0186	BM5G63PP4M010	120098-0188	BM5G32PP4M010	120098-0192

Face View (Male)	Max. Current per Contact	Max. Voltage	Configuration (D-Sub)	Micro-Change (M12) Connection			
				(2) Female Right Angle-to-Micro-Change		(1) Male Straight, (1) Female Straight	
				Engineering No.	Standard Order No.	Engineering No.	Standard Order No.
	4.0A	250V AC/DC	Horizontal	BM5G31PP4M010	120098-0194	BM5G70PP4M010	120098-0048
			Vertical	BM5G33PP4M010	120098-0196	BM5G72PP4M010	120098-0051

Note: Sales drawings for all standard order numbers are available on molex.com
*PROFIBUS is a trademark of PROFIBUS International

Configuration Code†
Build-a-Part Number

	Length	Code
Meters	1	M010
	2	M020
	5	M050
	10	M100

BM5G60PP4M010

†Once an engineering number is created using the configuration code, consult Molex tech support for information regarding any part numbers.

PROFIBUS* Brad® Mini-Change® Auxiliary Power A-Size Double-Ended Cordsets

130010
Internal Thread Female
External Thread Male
Straight, Right Angle



Features and Benefits

- Patented QuadBeam™ contact design for reliability and low resistance
- Flex-rated TC-ER cable

Reference Information

UL File No.: E152210
CSA File No.: LR6837

Electrical

Voltage: 600V AC/DC

Mechanical

Wire Size: 16 AWG

Physical

Connector Face: PVC
Connector Body: PVC
Contact: Brass with Gold over Nickel plating
Coupling Nut: Black epoxy-coated Zinc
Cable Jacket Color: Yellow
Cables: K12 and K13—UL Type TC-ER, Flex rated
A38 and A01—UL Type STOOW, extra hard service cord

Environmental

Protection: IP67

Poles (Female View)	Current	Wire Cable Type	Cable Jacket (Cable Code)	Length	Female Straight-to-Male Straight		Female Right Angle-to-Male Right Angle	
					Engineering No.	Standard Order No.	Engineering No.	Standard Order No.
	8.0A	TC-ER	TPE (K13)	2.0m	115030K13M020	130010-0103	115033K13M020	130010-0119
		STOOW	PVC (A01)		115030A01M020	130010-1256	115033A01M020	130010-1303

Note: Sales drawings for all standard order numbers are available on molex.com
*PROFIBUS is a trademark of PROFIBUS International

Configuration Code†
Build-a-Part Number

Meters	Length	Code
	1	M010
	2	M020
	5	M050
	10	M100

115030K13M0201

Coupling Nut Option
Stainless Steel 1

Cable Code
Orientation Code
Straight female-to-straight male 030
Right angle female-to-straight male . . . 031
Straight female-to-right angle male . . . 032
Right angle female-to-right angle male 033

†Once an engineering number is created using the configuration code, consult Molex tech support for information regarding any part numbers.

PROFIBUS* Brad® Mini-Change® Auxiliary Power A-Size Receptacles

130013

**Female
Internal Thread**



Features and Benefits

- Patented Quad Beam™ contact design for reliability and low resistance

Reference Information

UL File No.: E152210

Electrical

Voltage: 600V AC/DC

Mechanical

Wire Size: 16 AWG

Wire Type: UL 1015

Physical

Connector Face: PVC

Shell: Anodized Aluminum

Contact: Brass with Gold over Nickel plating

Mounting Thread: 1/2" - 14 NPT

Operating Temperature: -20 to +105° C

Environmental

Protection: IP67

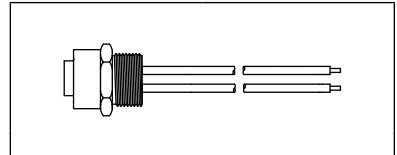

Poles (Female View)	Current	Length	Engineering No.	Standard Order No.
	8.0A	6.0'	1R5000A20F060	130013-0423

Note: Sales drawings for all standard order numbers are available on molex.com

*PROFIBUS is a trademark of PROFIBUS International

Configuration Code†
Build-a-Part Number

	Length	Code
Inches	12	A120
Feet	6	F060
Meters	2	M020

1R5000A20**F060**1

Coupling Nut Option
Stainless Steel..... 1

†Once an engineering number is created using the configuration code, consult Molex tech support for information regarding any part numbers.

PROFIBUS*
Brad® Mini-Change®
Auxiliary Power
Field Attachable Connectors
130017



- Features and Benefits**
- Patented Quad Beam™ contact provides high reliability
- Reference Information**
 CSA File No.: LR6837
- Electrical**
 Current: 8.0A max.
 Voltage: 600V AC/DC
- Mechanical**
 Wire Size: 15 to 24 AWG

- Physical**
 Connector Face: Polyurethane
 Connector Body: Nylon
 Contact: Brass with Gold over Nickel plating
 Coupling Nut: Nickel-plated Brass
 Cable Diameter: 5.08-11.43mm (.200-.450")
 Operating Temperature: -20 to +80° C
- Environmental**
 Protection: IP67

Poles (Female View)	Coupling Type	Female Straight		Male Straight	
		Engineering No.	Standard Order No.	Engineering No.	Standard Order No.
Internal Threads	1A5000-34				
	External Threads			1A5006-34	130017-0029

Note: Sales drawings for all standard order numbers are available on molex.com
 *PROFIBUS is a trademark of PROFIBUS International

PROFIBUS* Brad® Mini-Change® Auxiliary Power Tap Tee

120101
Data Line



Features and Benefits

- Phosphor bronze contacts for high reliability
- Can be connected directly to a Brad PROFIBUS I/O module
- Allows you to drop power from the main power trunk

Electrical

Voltage Rating: 600V
Amperage: 8.0A
Contact Material: Phosphor Bronze alloy
Contact Plating: Gold over Nickel

Physical

Connector Face: Thermo Plastic Elastomer
Molded Body: Thermo Plastic Elastomer
Coupling Nut: Zinc die-cast, Black e-coat
Operating Temperature: -4 to +176° F (-20 to +80° C)

Environmental

Protection: IP67

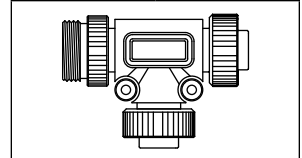

Poles	Code	Wiring Schematic	Engineering No.	Standard Order No.
<p>5 Pole</p>	<p>1 - Output Power V- 2 - Bus/Input Power V- 3 - Earth Ground 4 - Bus/Input Power V+ 5 - Output Power V+</p>		PBAPT	120101-0001
<p>5 Pole</p>				
<p>5 Pole</p>				

Note: Sales drawings for all standard order numbers are available on molex.com
*PROFIBUS is a trademark of PROFIBUS International

PROFIBUS* (M12) Auxiliary Power Brad® Ultra-Lock® and Micro-Change® Single-Ended Cordsets (US)

120065/120079
Female, Pigtails
Straight, Right Angle



Features and Benefits

- M12 Single Keyway (A-Coding) IEC compliant cordset assemblies
- 5-pole version for auxiliary power to devices in PROFIBUS installations
- Wide selection of cables to fit applications
 - PVC cables for light, cost-sensitive industrial applications
 - TPE cables for continuous-flex applications. Also ideal for welding cells, cable is weld slag resistant
 - Other versions available

Reference Information

UL File No.: E152210
CSA File No.: LR6837

Physical

Connector Body: PUR (TPE for K03)
Contact Carries: Polyamide
O-ring: Viton® (EPDM for A09 cables)
Coupling Nut: Nickel-plated Brass (Teflon® coated for K03)
Contacts: Copper alloy with Gold over Nickel plating
Cables: A09—Yellow PVC jacket, 22 AWG PVC conductors, 300V, UL AWM2661
K03—Yellow TPE jacket, 18 AWG PVC conductors, 300V, UL PLTC-ER, +5M flex life (torsion and bending)

Environmental

Protection: IP67
NEMA Rating: NEMA 6

Micro-Change

Poles (Female View)	Max. Current per Contact	Max. Voltage	Cable Type	Cable Jacket (Cable Code)	Wire Size AWG	Length	Female Straight		Female Right Angle	
							Engineering No.	Standard Order No.	Engineering No.	Standard Order No.
	4.0A	250V AC/DC	UL 2661	PVC (A09)	22	2.0m	805000A09M020	120065-0471	805001A09M020	120065-1697
			PLTC-ER	TPE (K03)	18		805000K03M020	120065-1367	805001K03M020	120065-1720

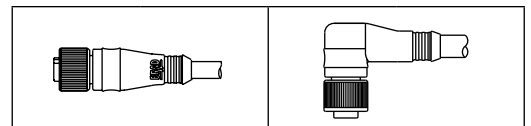

Ultra-Lock

Poles (Female View)	Max. Current per Contact	Max. Voltage	Cable Type	Cable Jacket (Cable Code)	Wire Size AWG	Length	Female Straight		Female Right Angle	
							Engineering No.	Standard Order No.	Engineering No.	Standard Order No.
	4.0A	250V AC/DC	UL 2661	PVC (A09)	22	2.0m	W05000A09M020	120079-0109	W05001A09M020	120079-0223

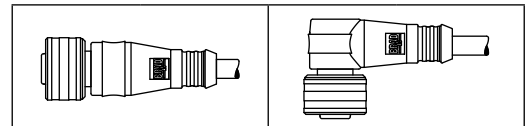

Note: Sales drawings for all standard order numbers are available on molex.com.

Teflon® and Viton® are registered trademarks of E.I. DuPont De Nemours and Company.

*PROFIBUS is a trademark of PROFIBUS International

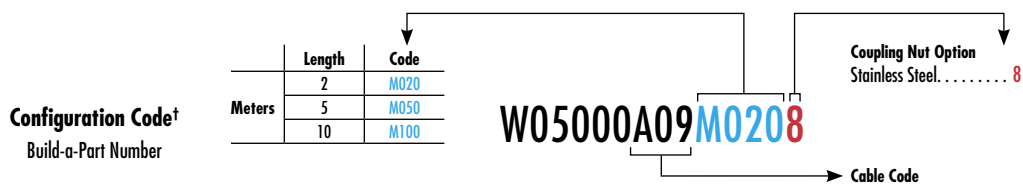

†Once an engineering number is created using the configuration code, consult Molex tech support for information regarding any part numbers.

PROFIBUS* (M12) Auxiliary Power Brad® Micro-Change® and Ultra-Lock® Double-Ended Cordsets (US)

120065/120079

Female Straight-to-Male Straight,
Female Right Angle-to-Male Right
Angle



Features and Benefits

- M12 Single Keyway (A-Coding) IEC compliant cordset assemblies
- 5-pole version for auxiliary power to devices in PROFIBUS installations
- Wide selection of cables to fit applications
 - PVC cables for light, cost-sensitive industrial applications
 - TPE cables for continuous-flex applications. Also ideal for welding cells, cable is weld slag resistant
 - Other versions available

Reference Information

UL File No.: E152210
CSA File No.: LR6837

Physical

Connector Body: PUR (TPE for K03)
Contact Carries: Polyamide
O-ring: Viton® (EPDM for A09 cables)
Coupling Nut: Nickel-plated Brass (Teflon® coated for K03)
Contacts: Copper alloy with Gold over Nickel plating
Cables: A09—Yellow PVC jacket, 22 AWG PVC conductors, 300V, UL AWM 2661
K03—Yellow TPE jacket, 18 AWG PVC conductors, 300V, UL PLTC-ER, +5M flex life (torsion and bending)

Environmental

Protection: IP67
NEMA Rating: NEMA 6

Micro-Change

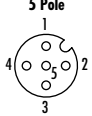
Poles (Female View)	Max. Current per Contact	Max. Voltage	Cable Type	Cable Jacket (Cable Code)	Wire Size AWG	Length	Female Straight-to-Male Straight		Female Right Angle-to-Male Right Angle	
							Engineering No.	Standard Order No.	Engineering No.	Standard Order No.
5 Pole 	4.0A	250V AC/DC	UL 2661	PVC (A09)	22	1.0m	885030A09M010	120066-0427	885033A09M010	120066-1634
			PLTC-ER	TPE (K03)	18		885030K03M010	120066-1034	885033K03M010	120066-1421

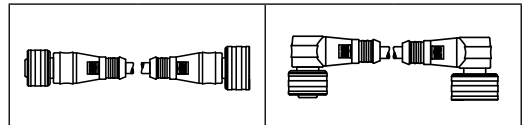

Ultra-Lock

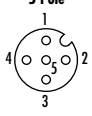
Poles (Female View)	Max. Current per Contact	Max. Voltage	Cable Type	Cable Jacket (Cable Code)	Wire Size AWG	Length	Female Straight-to-Male Straight		Female Right Angle-to-Male Right Angle	
							Engineering No.	Standard Order No.	Engineering No.	Standard Order No.
5 Pole 	4.0A	250V AC/DC	UL 2661	PVC (A09)	22	1.0m	WW5030A09M010	120080-0325	WW5033A09M010	120080-0431

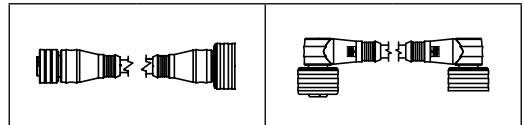

Note: Sales drawings for all standard order numbers are available on molex.com.

Teflon® and Viton® are registered trademarks of E.I. DuPont De Nemours and Company.

*PROFIBUS is a trademark of PROFIBUS International

Configuration Code†
Build-a-Part Number

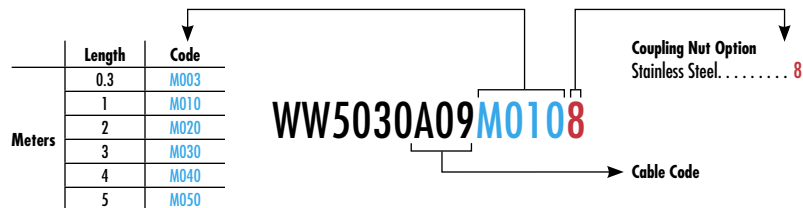

†Once an engineering number is created using the configuration code, consult Molex tech support for information regarding any part numbers.

PROFIBUS* (M12) Auxiliary Power Brad® Micro-Change® and Ultra-Lock® Single-Ended Cordsets (Europe)

120065/120079
Female Pigtail
Straight, Right Angle



Features and Benefits

- M12 Single Keyway (A-Coding) IEC compliant cordset assemblies
- 5-pole version for auxiliary power to devices in PROFIBUS installations
- Wide selection of cables to fit applications
 - PVC cables for light, cost-sensitive industrial applications
 - TPE cables for continuous-flex applications. Also ideal for welding cells, cable is weld slag resistant
 - Other versions available

Reference Information

UL File No.: E152210
CSA File No.: LR6837

Physical

Connector Body: PUR (TPE for K03)
Contact Carries: Polyamide
O-ring: Viton® (EPDM for A09 cables)
Coupling Nut: Nickel-plated Brass (Teflon® coated for K03)
Contacts: Copper alloy with Gold over Nickel plating
Cables: E03—Yellow PVC jacket, 0.34mm² PVC conductors, 300V, UL AWM 2464
K03—Yellow TPE jacket, 18 AWG PVC conductors, 300V, UL PLTC-ER, +5M flex life (torsion and bending)

Environmental

Protection: IP67
NEMA Rating: NEMA 6

Micro-Change

Poles (Female View)	Max. Current per Contact	Max. Voltage	Cable Type	Cable Jacket (Cable Code)	Wire Size	Length	Female Straight		Female Right Angle	
							Engineering No.	Standard Order No.	Engineering No.	Standard Order No.
	4.0A	250V AC/DC	UL 2661	PVC (E03)	0.34mm ²	2.0m	805000E03M020	120006-0634	805001E03M020	120006-0652
			PLTC-ER	TPE (K03)	18 AWG		805000K03M020	120065-1367	805001K03M020	120065-1720

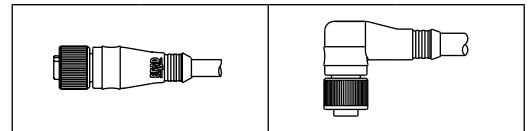

Ultra-Lock

Poles (Female View)	Max. Current per Contact	Max. Voltage	Cable Type	Cable Jacket (Cable Code)	Wire Size	Length	Female Straight		Female Right Angle	
							Engineering No.	Standard Order No.	Engineering No.	Standard Order No.
	4.0A	250V AC/DC	UL 2661	PVC (E03)	0.34mm ²	2.0m	W05000E03M020	120079-0277	W05001E03M020	120079-0281

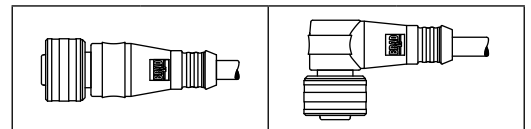

Note: Sales drawings for all standard order numbers are available on molex.com.

Teflon® and Viton® are registered trademarks of E.I. DuPont De Nemours and Company.

*PROFIBUS is a trademark of PROFIBUS International

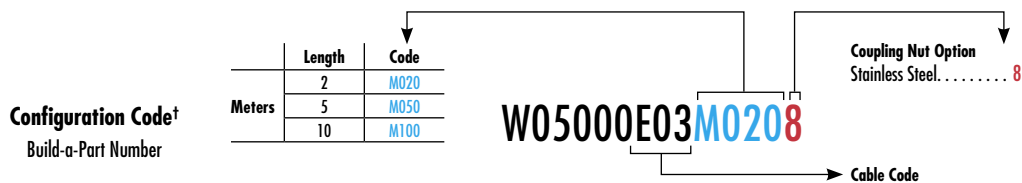

†Once an engineering number is created using the configuration code, consult Molex tech support for information regarding any part numbers.

PROFIBUS* (M12) Auxiliary Power Brad® Micro-Change® and Ultra-Lock® Double-Ended Cordsets (Europe)

120065/120079

Female Straight-to-Male Straight,
Female Right Angle-to-Male
Right Angle



Features and Benefits

- M12 Single Keyway (A-Coding) IEC compliant cordset assemblies
- 5-pole version for auxiliary power to devices in PROFIBUS installations
- Wide selection of cables to fit applications
 - PVC cables for light, cost-sensitive industrial applications
 - for welding cells, cable is weld slag resistant
 - Other versions available

Reference Information

UL File No.: E152210
CSA File No.: LR6837

Physical

Connector Body: PUR (TPE for K03)
Contact Carries: Polyamide
O-ring: Viton® (EPDM for A09 cables)
Coupling Nut: Nickel-plated Brass (Teflon® coated for K03)
Contacts: Copper alloy with Gold over Nickel plating
Cables: E03—Yellow PVC jacket, 0.34mm² PVC conductors, 300V, UL AWM 2464
K03—Yellow TPE jacket, 18 AWG PVC conductors, 300V, UL PLTC-ER, +5M flex life (torsion and bending)

Environmental

Protection: IP67
NEMA Rating: NEMA 6

Micro-Change

Poles (Female View)	Max. Current per Contact	Max. Voltage	Cable Type	Cable Jacket (Cable Code)	Wire Size	Length	Female Straight-to-Male Straight		Female Right Angle-to-Male Right Angle	
							Engineering No.	Standard Order No.	Engineering No.	Standard Order No.
	4.0A	250V AC/DC	UL 2661	PVC (A09)	0.34mm²	1.0m	885030E03M010	120007-0906	885033E03M010	120066-5402
			PLTC-ER	TPE (K03)	18 AWG		885030K03M010	120066-1034	885030K03M010	120066-1034

Ultra-Lock

Poles (Female View)	Max. Current per Contact	Max. Voltage	Cable Type	Cable Jacket (Cable Code)	Wire Size	Length	Female Straight-to-Male Straight		Female Right Angle-to-Male Right Angle	
							Engineering No.	Standard Order No.	Engineering No.	Standard Order No.
	4.0A	250V AC/DC	UL 2661	PVC (A09)	0.34mm²	1.0m	WW5030E03M010	120080-5076	WW5033E03M010	120080-5081

Note: Sales drawings for all standard order numbers are available on molex.com.

Teflon® and Viton® are registered trademarks of E.I. DuPont De Nemours and Company.

*PROFIBUS is a trademark of PROFIBUS International

Configuration Code†
Build-a-Part Number



†Once an engineering number is created using the configuration code, consult Molex tech support for information regarding any part numbers.

PROFIBUS* (M12) Auxiliary Power Brad® Ultra-Lock® and Micro-Change® Receptacles (US)

120084/120070

Female
Pigtail
Straight
Front Panel Mount
Bulkhead Pass-Through



Features and Benefits

- M12 Single Keyway (A-Coding) IEC compliant panel mount receptacles
- 5-pole version for auxiliary power to devices in PROFIBUS installations
- Fully potted assemblies provide IP67/68 protection for harsh environments

Physical

Shell: Nickel-plated Brass
Contact Carries: Polyamide
O-Ring: M12—Red Viton®
Panel—Black Viton
Contacts: Copper alloy with Gold over Nickel plating
Wire: PVC insulation 300V, 80° C, UL1061
3 to 5 poles—22 AWG

Environmental

Protection: IP67
NEMA Rating: NEMA 6

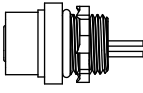
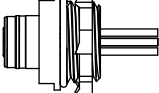
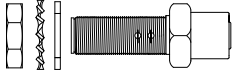
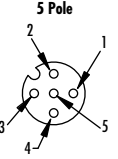
								
Configuration			Micro-Change (M12), 1/4"-18 NPT, Front Panel Mount	Ultra-Lock Enabled, 1/2"-14 NPT, Front Panel Mount	Micro-Change (M12), Bulkhead Pass-thru Receptacle			
Wire Type			PVC leads, UL1061	PVC leads, UL1061	N/A			
Wire Size AWG			22	22				
Length			12"	12"				
Poles	Max. Current per Contact	Max. Voltage	Engineering No.	Standard Order No.	Engineering No.	Standard Order No.	Engineering No.	Standard Order No.
5 Pole  1 - Brown 4 - Black 2 - White 5 - Grey 3 - Blue	4.0A	250V AC/DC	8R5A00A18A120	120070-0201	WR5000A18A120	120084-0016	8R5L30	120070-0237

Note: Sales drawings for all standard order numbers are available on molex.com.

Viton® is a registered trademark of E.I. DuPont De Nemours and Company.

*PROFIBUS is a trademark of PROFIBUS International

Configuration Code†
Build-a-Part Number

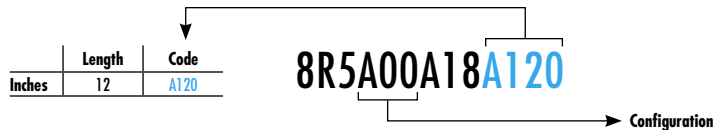

†Once an engineering number is created using the configuration code, consult Molex tech support for information regarding any part numbers.

PROFIBUS* (M12) Auxiliary Power Brad® Ultra-Lock® and Micro-Change® Receptacles (Europe)

120070/120084

Female
Front Panel Mount
Bulkhead Pass-Through



Features and Benefits

- M12 Single Keyway (A-Coding) IEC compliant panel mount receptacles
- 5-pole version for auxiliary power to devices in PROFIBUS installations
- Fully potted assemblies provide IP67/68 protection for harsh environments

Physical

Shell: Nickel-plated Brass
Contact Carries: Polyamide
O-Ring: M12—Red Viton®
Panel—Black Viton
Contacts: Copper alloy with Gold over Nickel plating
Wire: PVC insulation 300V, 80° C, UL1061,
3 to 5 poles—22 AWG

Environmental

Protection: IP67
NEMA Rating: NEMA 6

Poles	Max. Current per Contact	Max. Voltage	Configuration		Wire Type		Length	
			Engineering No.	Standard Order No.	Engineering No.	Standard Order No.	Engineering No.	Standard Order No.
<p>5 Pole 1 - Brown 4 - Black 2 - White 5 - Grey 3 - Blue</p>	4.0A	250V AC/DC	Micro-Change (M12), PG9, Front Panel Mount	Ultra-Lock Enabled, PG9, Front Panel Mount	PVC leads, UL1061	PVC leads, UL1061	N/A	
					0.34mm ²	0.34mm ²		
					0.3m	0.3m		
			8R5J20E03C3003	120070-5207	WR5J20E03C3003	120084-5159	8R5L30	120070-0237

Note: Sales drawings for all standard order numbers are available on molex.com.
Viton® is a registered trademark of E.I. DuPont De Nemours and Company.
*PROFIBUS is a trademark of PROFIBUS International

Configuration Code†
Build-a-Part Number

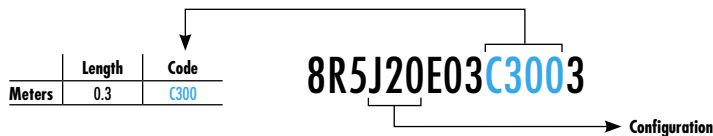

†Once an engineering number is created using the configuration code, consult Molex tech support for information regarding any part numbers.

PROFIBUS* (M12) Auxiliary Power Field Attachable Brad® Ultra-Lock® and Micro-Change® Connectors

120071/120085

Female, Male
Straight

Features and Benefits

- Allows field termination of cables to IEC compliant M12 A-Coding connector
- Preassembled contact carries with screw terminals provides easy field termination of conductors
- 5-pole version for auxiliary power to devices in PROFIBUS installations
- Back end housing and cable gland provides IP67 protection and strain relief

Physical

Connector Body: PA
Contact Carries: PA
O-ring: Viton®
Coupling Nut: Nickel-plated Brass
Contacts: Copper alloy with Gold over Nickel plating
Termination: Screw down terminals, accepts conductors up to 18 AWG (0.75mm²)

Environmental

Protection: IP67
NEMA Rating: NEMA 6



Micro-Change

Pole (Female View)	Max. Current per Contact	Max. Voltage	Cable Diameter Range	Female Straight		Male Straight	
				Engineering No.	Standard Order No.	Engineering No.	Standard Order No.
	4.0A	250V AC/DC	4.10-8.10mm (.161-.319")	8A5000-32	120071-0043	8A5006-32	120071-0047

Ultra-Lock

Pole (Female View)	Max. Current per Contact	Max. Voltage	Cable Diameter Range	Female Straight		Male Straight	
				Engineering No.	Standard Order No.	Engineering No.	Standard Order No.
	4.0A	250V AC/DC	4.10-8.10mm (.161-.319")	WA5000-32	120085-0014	WA5006-32	120085-0006

Note: Sales drawings for all standard order numbers are available on molex.com.

Viton® is a registered trademark of E.I. DuPont De Nemours and Company.

*PROFIBUS is a trademark of PROFIBUS International

Brad® Ethernet

Brad ethernet products provide solutions that enable the world's most popular Local Area Network to be reliably utilized on the factory floor or in harsh commercial environments. The Brad line offers a large choice of products including physical media, IP67 I/O modules, unmanaged and managed switches, powerful network interfaces, industrial gateways and protocol development kits to connect the most popular Ethernet industrial networks and fieldbuses. Brad Ethernet products give the user a complete communication and connectivity solution to design a large scope of industrial applications—PC-Based control, supervision, data storage, protocol bridging, etc.—to suit all industry sectors.

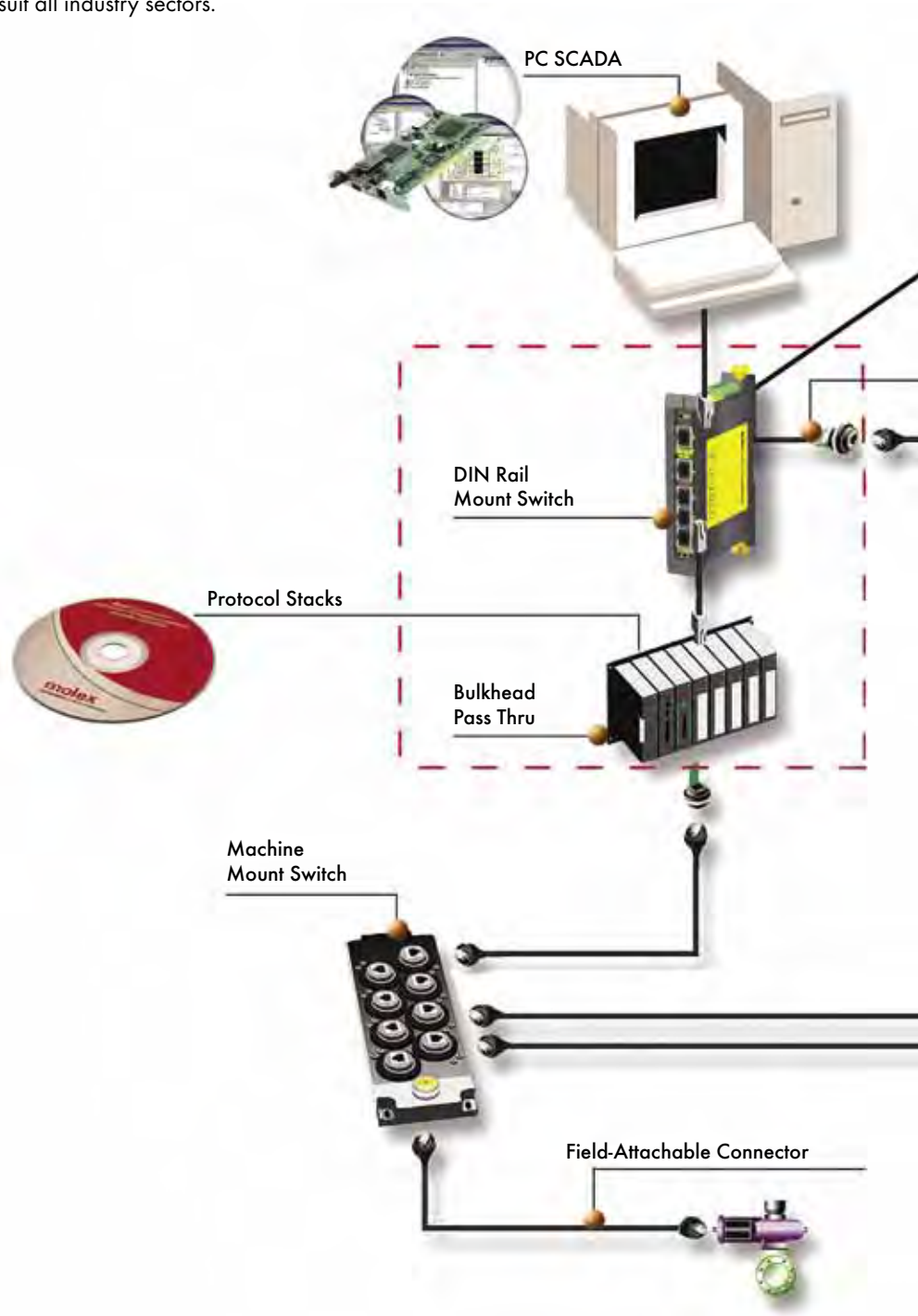

Brad[®] Ethernet

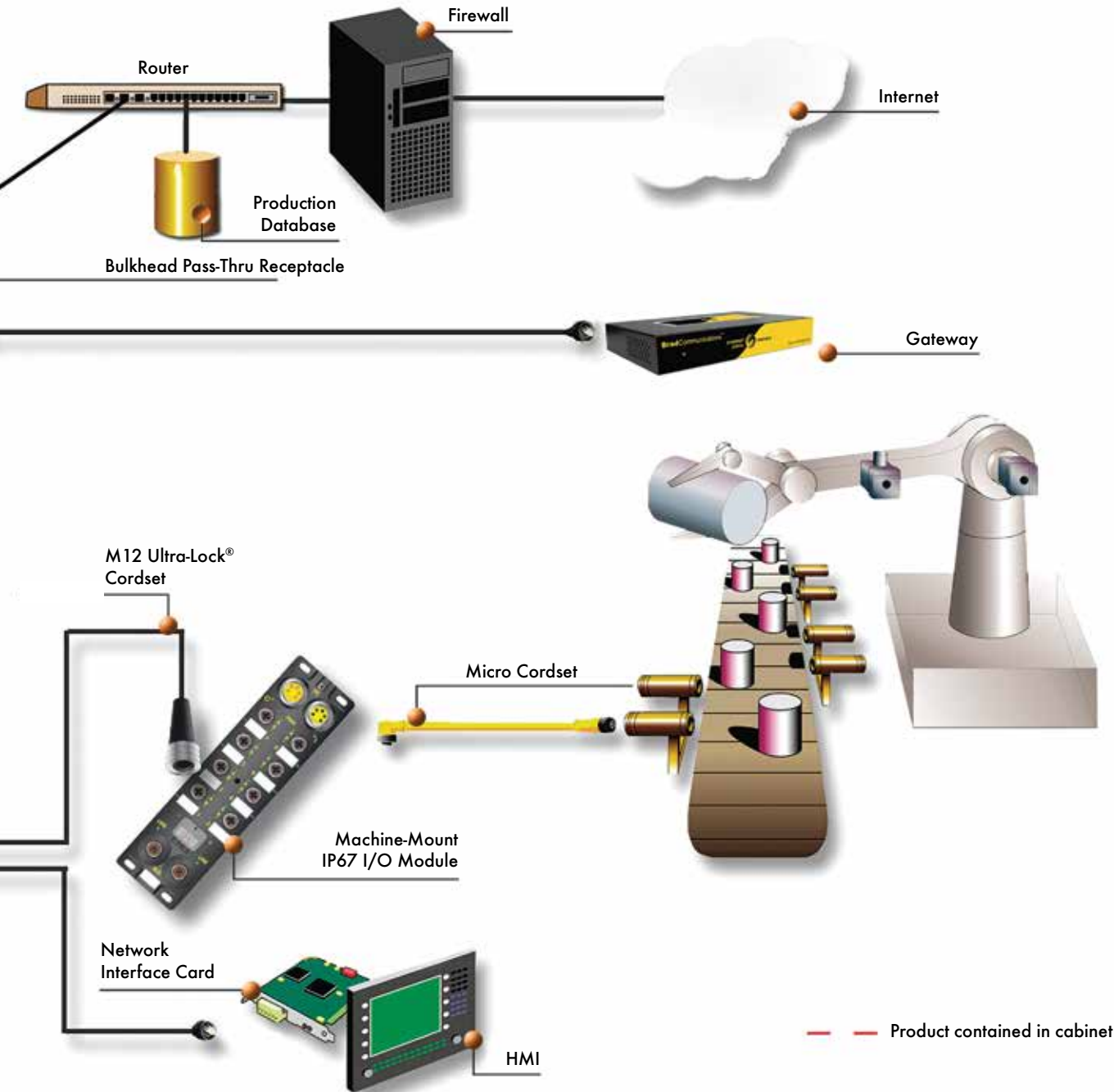

Brad® Ethernet Software Development Kit for PROFINET IO

112106

IO-Controller and IO-Device



Features and Benefits

- Master and slave protocol stacks can address both controller (master) or device (slave) manufacturers who want to implement PROFINET networks
- Brad stacks have no hardware and OS dependencies and can be easily implemented on a large range of hardware system platforms or software operating systems
- Sample applications with source codes are provided and can be quickly and easily implemented
- Brad stacks are successfully tested with PNO conformance test tools
- Molex can provide stack training, technical support and engineering development for both hardware and software design

Description

- PROFINET IO Class-A/Class-B (RT Class-1, RT Class-2)
- Portable on any real time or not operating systems implementing multithread (Windows, VxWorks, Linux, QNX, ThreadX, eCOS, etc)
- Hardware: Compatible with 32-bit microprocessors
- Multiplatform (Intel, ARM, PowerPC, Fido, Texas DSP, etc)
- Support of Intel and Motorola formats
- Consistent IO data access through shared memory (configurable or automatic) or messaging access (API)

Conformance

- Conforms to PROFINET IO specifications v2.2
- Molex is an active member of PROFINET technical working groups

Included Hardware/Software

PROFINET IO—Controller Stack

- Supported Services: Context management, configuration, IO data, alarm, and diagnostic
- Manage up to 128 IO-Devices
- Cyclic Data Exchange: Up to 1440 Input bytes and 1440 Output bytes per IO-Device slot
- IP Device Configuration: DCP or Local
- LLDP (PROFINET MIB)
- SDK initialization via XML file
- CD Deliverable: Single product line licensing (with royalties), ANSI C source code, electronic documentation, application samples

PROFINET IO Device Stack

- IO Data: Up to 1440 Input bytes and 1440 Output bytes per IO-Device slot
- GSD File: Yes
- IP Device Configuration: DCP or Local
- LLDP (PROFINET MIB)
- Allows design of fixed and modular device

OEM Engineering Console

- Generate IO-Controller stack configuration files (XML format)
- Automatic IO-Device network detection including module configuration
- GSD device library management
- IO-Device commissioning (Set Name, Device blinking, etc.)
- Integrated diagnostic
- Windows 32-bit (XP, Vista)
- OEM customization
- USB dongle protection

MRP Client/Manager Stack

- Manage media redundancy for Ethernet ring topology according PROFINET Class-B
- CD Deliverable: Single product line licensing (no royalty), ANSI C source code, electronic documentation
- Does not include PNO MRP patent

Ordering Information

Description	Engineering No.	Standard Order No.
PROFINET IO-Device Software Development Kit	SDK-PFN-DEV	112106-5001
PROFINET IO-Device SDK Maintenance Update	SDK-PFN-DEV-UPD	112106-5002
PROFINET IO-Controller Software Development Kit—1 License Fee included	SDK-PFN-CON	112106-5005
PROFINET IO-Controller SDK Maintenance Update	SDK-PFN-CON-UPD	112106-5006
PROFINET IO-Controller OEM Configuration Console, USB Dongle, 1 license	SDK-PFN-CON-CNF-U	112106-5012
Client/Manager Media Redundancy Protocol SDK for PROFINET IO	SDK-PFN-MRP	112106-5007

Support/Training Information

Description	Engineering No.	Standard Order No.
Engineering Development Support for PROFINET stack	SDK-PFN-EDS	860000-0142
Training Support for PROFINET stack	SDK-PFN-TRN	860000-0144

Brad® Ethernet Software Development Kit for EtherNet/IP*

112106

Scanner and Adapter



Features and Benefits

- Master and slave protocol stacks can address both controller (master) or device (slave) manufacturers who want to implement EtherNet/IP networks
- Brad stacks have no hardware and OS dependencies and can be easily implemented on a large range of hardware system platforms or software operating systems
- Sample applications with source codes are provided and can be quickly and easily implemented
- Brad stacks are successfully tested with ODVA conformance test tools
- Molex can provide stack training, technical support and engineering development for both hardware and software design

Description

- Portable on any real time or not operating systems implementing multithread (Windows, VxWorks, Linux, QNX, ThreadX, eCOS, etc)
- Hardware: Compatible with 32-bit microprocessors
- Multi platform (Intel, ARM, PowerPC, etc)
- Support of Intel and Motorola formats
- Consistent process data image access through messaging access (API)

Conformance

- Conforms to ODVA specifications v1.4 and CIP v3.3
- Fully compatible with EtherNet/IP Conformance Test Suite Version A7
- Molex is an active member of ODVA technical working groups

Included Hardware/Software

EtherNet/IP Scanner and Adapter

- CIP Features:
 - IO messaging (process data)
 - Explicit messaging (configuration/diagnostic)
- Supported Objects according to CIP Standard
 - Identity Object
 - Message Router Object
 - Assembly Object
 - Connection Manager Object
 - Connection Configuration Object
 - TCP/IP Interface Object
 - Ethernet Link Object
- Stack Resolution: Timing resolution in microseconds
- Application Watchdog
- Rack Optimization for best performances with PointIO and FlexIO devices
- CD Deliverable: single product line licensing (with royalties), ANSI C source code, electronic documentation, application samples

Included Hardware/Software (continued)

EtherNet/IP Adapter

- CIP Features:
 - IO messaging (process data)
 - Explicit messaging (configuration/diagnostic)
- Supported Objects according to CIP Standard
 - Identity Object
 - Message Router Object
 - Assembly Object
 - Connection Manager Object
 - Connection Configuration Object
 - TCP/IP Interface Object
 - Ethernet Link Object
- Stack Resolution: Timing resolution in microseconds
- Application Watchdog
- Generic EDS file
- CD Deliverable: single product line licensing (no royalty), ANSI C source code, electronic documentation, application samples

OEM Engineering Console

- Generate EtherNet/IP stack configuration files
- Automatic EtherNet/IP network detection including module configuration
- ESD device library management
- Device commissioning
- Integrated diagnostic
- Windows 32-bit (XP, Vista)
- OEM customization
- USB dongle protection

Ordering Information

Description	Engineering No.	Standard Order No.
EtherNet/IP Adapter Software Development Kit	SDK-EIP-ADP	112106-0000
EtherNet/IP Adapter SDK Maintenance Update	SDK-EIP-ADP-UPD	112106-5000
EtherNet/IP Scanner/Adapter Software Development Kit—1 License Fee included	SDK-EIP-SCA	112106-5003
EtherNet/IP Scanner/Adapter SDK Maintenance Update	SDK-EIP-SCA-UPD	112106-5004
EtherNet/IP Scanner OEM Configuration Console, USB Dongle, 1 license	SDK-EIP-CON-CNF-U	112106-5011

Support/Training Information

Description	Engineering No.	Standard Order No.
Engineering Development Support for EtherNet/IP stack	SDK-EIP-EDS	860000-0141
Training Support for EtherNet/IP stack	SDK-EIP-TRN	860000-0143

*EtherNet/IP is a trademark of ODVA (Open Device Vendor Association)

Brad® Windows Compatible Multi-Slave Driver for PROFINET

112027
PROFINET Multi IO-Device



Features and Benefits

- Connect a PC under Windows to PROFINET controller
- Use standard Ethernet card
- Support PROFINET IO Real-Time communication
- Support multi-slave functionality on single PC by using multiple Ethernet ports
- Typical applications:
 - HMI/Operator panel
 - Workbench
 - IO simulation

Description

- Conform to PROFINET IO v2.2 specifications
- Support up to 32 IO-Device connections in a single PC
- Support PROFINET Alarms
- Engineering Tools:
 - Configuration console
 - Test and diagnostic tools
- Includes Windows Library (DLL)
- Windows (32-bit): Seven, 2008 Server, Windows Vista®, 2003 Server, Windows XP®

Included Hardware/Software

- IO Data: Up to 1440 Input bytes and 1440 Output bytes per IO-Device slot
- Automatic generation of GSD file based on user configuration ready to use in PROFINET I/O-Controller engineering software
- Allows design of fixed and modular device
- IP Device configuration: DCP or Local
- Software Protection

Conformance

- Conform to PNO conformance test tool (PN Tester)
- Molex is an active member of PROFINET technical working groups

Description	Engineering No.	Standard Order No.
Windows PROFINET Multi IO-Device Driver, Software protection key	DRL-EPN-SWF-S	112027-5007

Brad® Windows Compatible Explicit Messaging Driver for EtherNet/IP*

112106
EtherNet/IP EM Driver



Features and Benefits

- Fastest and easiest solution to implement EtherNet/IP Explicit Messaging communication on PC-based systems
- User friendly library, no EtherNet/IP knowledge required
- Typical applications:
 - Engineering tool
 - Commissioning console
 - Diagnostic and Monitoring tools
 - HMI/SCADA applications
 - Custom software

Description

- EIP_Driver provides an Application Programming Interface (API) that simply send/receive buffer of data on the network with remote EtherNet/IP EM Server devices
- The EIP_Driver manages the complete CIP communication (connection/reconnection, etc) so the developer needs no special expertise in the EtherNet/IP protocol.

Included Hardware/Software

- Send and receive explicit messages
- Client mode (Server mode on request)
 - Supports connected and unconnected messages
 - Supports synchronous and asynchronous modes
- Support of List Identify service to detect all EtherNet/IP stations connected to the network
- DLL library for Windows 32-bit (Seven/XP/Vista)
 - Designed to be used in multi-threaded applications
 - Several applications can use the EIP_Driver simultaneously
- DLL library can be statically or dynamically linked with the target application
- CD Deliverable: single product line licensing (no royalty), ANSI C source code, electronic documentation, application samples

Conformance

- Fully compatible with EtherNet/IP Conformance Test Suite Version A7
- Molex is an active member of ODVA (Open DeviceNet® Vendor Association) technical working groups

Description	Engineering No.	Standard Order No.
EtherNet/IP Explicit Messaging DLL library, Client mode	SDK-EIP-EML	112106-5008

*EtherNet/IP is a trademark of ODVA (Open Device Vendor Association)

Brad® Direct-Link® Windows Compatible Protocol Drivers

112027

Ethernet TCP/IP and Serial



Features and Benefits

- Direct-Link SW1000 provides data acquisition between Windows PC-based applications and industrial devices connected to Ethernet TCP/IP
- Economic solution; well suited for embedded and light architecture (laptop, panel PC, MMI)
- 100% software solution; use PC COM port or integrated Ethernet interface (3COM, NE2000)
- Wide variety of open and vendor specific industrial protocols
- 1000 tags, full tags and Siemens (S5, S7, TI) versions

Description

- Based on Windows TCP/IP socket
- All Ethernet protocols can run simultaneously
- All Ethernet protocols can run Client and Server modes
- Database (32 Kbits, 32 Kwords) for Server mode to exchange data with applications

Included Hardware/Software

- Engineering Tools:
 - Engineering console
 - Test and diagnostic tools
- Compatible Data Servers:
 - OPC DA v3.0, 2.05 and 1.0a
 - Wonderware® DAServer (XP only)
 - Wonderware I/O (SuiteLink/FastDDE) (XP only)
- Includes Development Libraries
- Windows Compatibility (32-bit and 64-bit): 7, 2008 Server, Windows Vista®, 2003 Server, Windows XP®
- Software or dongle (Parallel or USB) protection

Compatible Protocols

Ethernet TCP/IP

- Altus® Alnet II (AL200x, webgate); Client/Server
- Alstom® SRTP (C80-35, C80-75); Client/Server
- Allen-Bradley® Logix5000 (ControlLogix and FlexLogix); Client/Server
- GE Fanuc® SRTP (C90-30, C90-70); Client/Server
- Mitsubishi® Melsec (A and Q); Client/Server
- Omron® FINS (C, CV, CS); Client/Server
- Schneider® Modbus TCP and UDP; Client/Server
- Schneider UNI-TE (Premium and Micro); Client/Server
- Siemens® Industrial Ethernet (S5, S7, TI); Client/Server

Serial

- Modbus Master (ASCII and RTU)
- Modbus Slave (ASCII and RTU)
- GE Fanuc SNPX Master (90-xx and 80-xx Series)
- Schneider Uni-Telway Slave (TSX 7 Series)
- Siemens AS511 Master (Simatic S5 Series)
- Siemens PPI/PPI+ Master (Simatic S7-200 Series)
- Siemens Ti-Dir Master (Simatic TI-505 Series)

Description	Engineering No.	Standard Order No.
SW1000 software drivers, 1000 tags, Software key protection.	DRL-ALL-SWL-S	112027-0005
SW1000 software drivers, Full tags, Software key protection.	DRL-ALL-SWF-S	112027-0002
SW1000 for Siemens (S5, S7, TI), Full tags, Software key protection.	DRL-SIE-SWF-S	112027-5014
SW1000 software drivers, 1000 tags, USB dongle protection	DRL-ALL-SWL-U	112027-0006
SW1000 software drivers, Full tags, USB dongle protection	DRL-ALL-SWF-U	112027-0003
SW1000 for Siemens (S5, S7, TI), Full tags, Software key protection.	DRL-SIE-SWF-U	112027-5015
SW1000 upgrade from 1000 tags to Full tags	DRL-UPG-SWF	112027-0010

Brad® applicom® Network Interface Card

112000 Industrial Ethernet



Features and Benefits

- Fast data acquisition between PC-based applications and industrial devices connected to Ethernet TCP/IP
- On board co-processor eliminates data bottlenecks, ensuring delivery of time critical information
- All protocols are included
- Best choice for Supervision/HMI/SCADA applications
- Equipment redundancy via OPC server
- Combo offer:
 - Ethernet + PROFIBUS (1.5 Mbps)
 - Ethernet + Serial (38.4 Kbps)

Description

- Engineering Tools:
 - Engineering console
 - Test and diagnostic tools
- Compatible Data Servers:
 - OPC DA v3.0
 - Wonderware® DAServer (XP only)
 - Wonderware IO (SuiteLink/FastDDE) (XP only)
- Includes Development Libraries
- Supported OS:
 - Windows (32-bit and 64-bit): Seven, 2008 Server, Windows Vista®, 2003 Server, Windows XP®/XP Embedded
 - Others: Linux, VxWorks, RTX VenturCom

Included Hardware/Software

- Bus Format
 - PCI Universal bus 3.3V/5V (PCI-X compatible)
 - PCI Express 1x
- Hardware plug and play
- AMD SCS20
- 16 Mb SDRAM
- 4 Mb Flash Memory
- One Ethernet port
 - Fast Ethernet 10/100 Mbps, auto negotiating
 - Base-T (RJ45), 4 LEDs (Rx, Tx, Link, 10/100)

Compatible Protocols

Ethernet TCP/IP (Client/Server modes)

- Altus® Alnet II (AL 200x, Webgate)
- Alstom® SRTP (C80-35, C80-75)
- Allen-Bradley® EtherNet/IP* (PCCC) (Logix, PLC-5 and SLC 500)
- GE Fanuc® SRTP (90-30, 90-70)
- Mitsubishi® Melsec (A, Q)
- Omron® FINS (C, CV, CS)
- Schneider Electric® Open Modbus TCP
- Schneider Electric UNI-TE (Premium and Micro)
- Siemens® Industrial Ethernet (S5, S7, TI)
- UDP Send/Receive (Free messaging)

Ethernet ISO

- Schneider Electric® Ethway
- Siemens® Industrial Ethernet ISO (S5, S7, TF and TI)

Conformance

- RoHS compliant
- CE
- OPC certified
- Rockwell Encompass™
- Schneider Collaborative

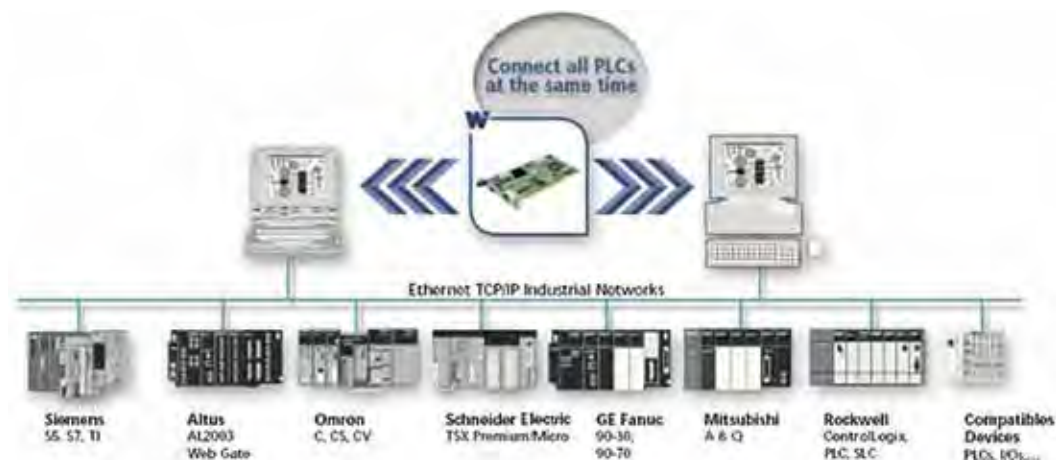

Description	Engineering No.	Standard Order No.
PCU2000ETH PCI Network Interface Card for Ethernet	APP-ETH-PCU-C	112000-0005
PCIE2000ETH PCI Express Network Interface Card for Ethernet	APP-ETH-PCIE	112000-5026
PCU2000ETH PCI Network Interface Card for Ethernet + Profibus	APP-EPB-PCU-C	112000-0001
PCIE2000ETH PCI Express Network Interface Card for Ethernet + Profibus	APP-EPB-PCIE	112000-5028
PCU2000ETH PCI Network Interface Card for Ethernet + Serial	APP-ESR-PCU-C	112000-0003
PCIE2000ETH PCI Express Network Interface Card for Ethernet + Serial	APP-ESR-PCIE	112000-5027

*EtherNet/IP is a trademark of ODVA (Open Device Vendor Association)

Brad® applicom® Network Interface Card

112000

Ethernet Fieldbus



Features and Benefits

- Deterministic data acquisition for real time PC-based control applications
- On board co-processor eliminates data bottlenecks, ensuring delivery of time critical information
- Very Easy-to-Use; no knowledge of protocol required
- Remote Access via TCP/IP connection; to able configuration and diagnostic when using real time OS (VxWorks, QNX, etc.)

Description

- Auto mapping of IO in card DPRAM
- IO exchange up to 14 Kbytes
- Hardware and software Watchdog
- Auto-Boot (Configuration stored in Flash)
- Engineering Tools:
 - Engineering console with automatic test and diagnostic tools
- Compatible Data Servers:
 - OPC DA v3.0, 2.05 and 1.0a
 - Wonderware® DAServer
 - Wonderware IO (SuiteLink/FastDDE)
- Includes Development Libraries
- Supported OS:
 - Windows (32-bit and 64-bit): 7, 2008 Server, Windows Vista®, 2003 Server, Windows XP®/XP Embedded
 - Others: Linux, VxWorks, RTX VenturCom

Included Hardware/Software

- PCI Universal bus 3.3V/5V (PCI-X compatible)
- Hardware plug and play
- AMD SC520
- 16 Mb SDRAM; 4 Mb Flash Memory
- 1 Digital Input + 1 Digital Output
- 1 Ethernet port
 - Fast Ethernet 10/100 Mbps, auto negotiating
 - Base-T (RJ45), 4 LEDs (Rx, Tx, Link, 10/100)

Compatible Protocols

Modbus TCP and UDP

- Client mode
- Up to 127 simultaneous devices

Compatible Protocols (continued)

EtherNET/IP*

- Scanner and adapter
- Explicit messaging (Client/Server)
- Up to 128 simultaneous CIP connections
- EtherNet/IP Devices supported: Generic and Rockwell IO through EDS files (FlexIO, CompactLogix, etc.)
- IP address settings configurable via the console or DHCP/BOOTP server
- Client DNS Supported

PROFINET IO-Controller

- RT Class-1
- Up to 127 IO-Devices; max. IO size 14K
- Cyclic Data Exchange (IO); up to 1437 In and 1437 Out per device
- Acyclic Data Exchange (for Configuration + Diagnostic)
- Minimum cycle time 1 ms
- Alarm handling
- IP Address manager
- Commissioning tool (set name, set IP address, device blinking, etc.)

PROFINET IO-Device

- RT Class-1
- Up to 1437 In and 1437 Out; 1 slot for Inputs + 1 slot for Outputs
- Instructions and Maintenance 0, 1, 2, 3
- 1x Record for user custom diagnostics
- Process and Diagnostic Alarm
- GSD file

Conformance

- RoHS compliant
- CE
- OPC certified
- ODVA conformance tested
- Rockwell Encompass™

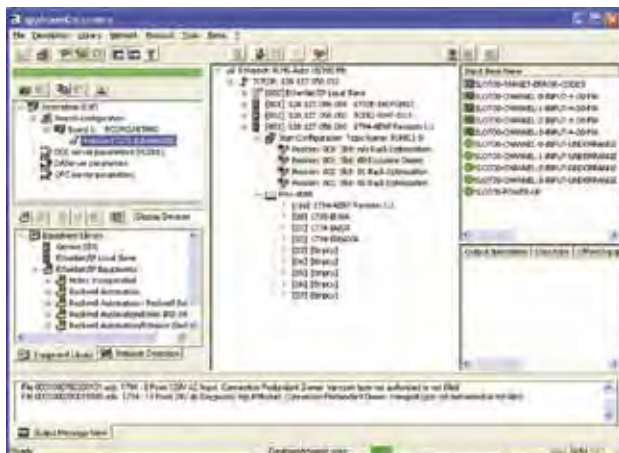

Configuration Console



Device Diagnostics

Description	Engineering No.	Order No
PCU-ETHIO PCI Network Interface Card for Modbus TCP/IP	DRL-EMB-PCU	112000-5029
PCU-ETHIO PCI Express Network Interface Card for Modbus TCP/IP	DRL-EMB-PCIE	112000-5034
PCU-ETHIO PCI Network Interface Card for EtherNet/IP	DRL-EIP-PCU	112000-5030
PCU-ETHIO PCI Express Network Interface Card for EtherNet/IP	DRL-EIP-PCIE	112000-5033
PCU-ETHIO PCI Network Interface Card for PROFINET IO	DRL-EPN-PCU	112000-5031
PCU-ETHIO PCI Express Network Interface Card for PROFINET IO	DRL-EPN-PCIE	112000-5032

*EtherNet/IP is a trademark of ODVA (Open Device Vendor Association)

Brad® SST™ Communication Module for Rockwell® ControlLogix

112073

Modbus TCP and Serial



Features and Benefits

- Connects your Allen-Bradley® ControlLogix to a Modbus Ethernet or Serial network
- Direct IO Mapping, no Ladder Logic to write for configuration and data transfer between module and CLX processor
- Fully integrated into the Rockwell Automation environment
- User-friendly configuration tool with intuitive graphical interface

Description

- RLL support: remote configuration and monitoring via RSLinx
- Add-On-Profile for Rockwell RSLogix5000
- USB port for user configuration and firmware upgrade
- Engineering console simplified user configuration and diagnostic
- Support multiple modules in a chassis
- Support Local and Remote chassis
- Easy diagnostics: Built-in LEDs and 4 characters display

Included Hardware/Software

- 128 MB of onboard memory
- 8 MB of flash memory (user configuration data and firmware)
- CPU Data exchange:
 - 496 Inputs bytes + 496 Output bytes
 - 32,000 Words Registers (CIP messaging)
- Type A, USB 2 and 1.1 compatible
- Communication Ports
 - 1x Ethernet, 10/100 Mbps, RJ45
 - 2x Serial, 110 bps to 115.2 kbps, RS232/RS485/RS422, RJ45 (DB9 male supplied cable)

Compatible Protocols

- Modbus Master (RTU or ASCII)
- Modbus Slave (RTU or ASCII)
- Modbus TCP and UDP Client and Server

Conformance

- RoHS compliant
- CE, UL, cUL
- Class 1 Div 2
- Rockwell Encompass™

Description	Engineering No.	Standard Order No.
Modbus communication module for Rockwell ControlLogix	SST-ESR2-CLX-RLL	112073-0001

Brad® HarshIO 600

112095

Digital IP67 IO module



Features and Benefits

- Reliable solution for connecting industrial controllers to IO devices in harsh duty environments.
- Accepts M12 threaded connectors or Brad Ultra-Lock® Push-Pull connection system
- Standard hole housing pattern allows for interchangeability with popular IO modules
- User configurable versions; user can set up each digital channel as either an input or output
- Scrolling 4 characters and visible LEDs provide maintenance personnel with the ability to easily determine IO, module and network status

Description

- Rated IP67 for harsh environments
- Designed for direct machine mount applications
- Sixteen digital input/output per module
- Supports PNP and NPN input devices
- IP addressing via BootP, DHCP or static (through web interface, push button and PLC Scanner command)
- Built-in 2-port Ethernet switch for daisy chain topology
- Configurable IO capability (through web interface and PLC Scanner commands)
- Watchdog with output reply state
- Built-in web server for remote configuration and diagnostics

Compatible Protocols

- Modbus TCP and UDP Server
- EtherNet/IP* Adapter
- PROFINET IO-Device

Conformance

- IP67 according to IEC 60529
- NEMA 6P
- Vibration: MIL-STD-202F, method 204D, condition A
- Mechanical Shock: MIL-STD-202F, method 213B, condition B
- Thermal Shock: MIL-STD-1344A
- CE, UL, cUL
- RoHS compliant
- ODVA certified
- PNO certified

Included Hardware/Software

- IO Configurations:
 - 16 inputs
 - 14 inputs + 2 outputs
 - 12 inputs + 4 outputs
 - 8 inputs + 8 outputs
 - Universal
 - User configurable
- IO Connectors: 8x M12 ports, Ultra-Lock M12 female 5-pole, internally threaded
- Ethernet Connectors: Ultra-Lock M12 female, 4-pole D-Coded acting as a switch, crossover capability
- Power Connectors:
 - Power In—Male Mini-Change®, 4- or 5-pole
 - Power Out—Female Mini-Change, 4- or 5-pole
- Power Requirements:
 - Module Input Power—24V DC
 - Module Output Power—24V DC, 2.0A max. per channel, 8.0A max. per module
- Communication Rate: 10/100 Mbps auto-sensing, auto-crossing, half/full duplex
- Input Type:
 - Compatible with dry contact and PNP or NPN 3-wire switches.
 - Electronic short circuit protection
- Input Delay: 2.5ms default or configurable (through web interface and PLC Scanner commands)
- Input Device Supply: 200mA per port at 25° C
- Output Load Current: 2.0A max. per channel, electronic short circuit protection
- Maximum Switching Frequency: 200 Hz
- Housing Dimensions: 60.00 by 220.00 by 20.00mm (2.36 by 8.66 by .78")
- Mounting Dimensions:
 - 37.50mm (1.48") horizontal on centers
 - 210.00mm (8.27") vertical on centers
 - Center hole
- Operating Temperature: -25 to +70° C
- Storage Temperature: -40 to +85° C

Modbus TCP

No. of Power Pins	IO Configuration		Input Channel Type	Engineering No.	Standard Order No.
	Input	Output			
5	16		NPN	TCDEM-8D0N-D1U	112095-0007
5	14	2	NPN	TCDEM-8C2N-D1U	112095-0005
5	12	4	NPN	TCDEM-8B4N-D1U	112095-0003
5	8	8	NPN	TCDEM-888N-D1U	112095-0001
5	16		PNP	TCDEM-8D0P-D1U	112095-0008
5	14	2	PNP	TCDEM-8C2P-D1U	112095-0006
5	12	4	PNP	TCDEM-8B4P-D1U	112095-0004
5	8	8	PNP	TCDEM-888P-D1U	112095-0002
5	16 User Configurable		User Configurable	TCDEM-8YX-D1U	112095-0009
4	16		NPN	TCDEM-8D0N-DYU	112095-5021
4	14	2	NPN	TCDEM-8C2N-DYU	112095-5022
4	12	4	NPN	TCDEM-8B4N-DYU	112095-5023
4	8	8	NPN	TCDEM-888N-DYU	112095-5024
4	16		PNP	TCDEM-8D0P-DYU	112095-5025
4	14	2	PNP	TCDEM-8C2P-DYU	112095-5026
4	12	4	PNP	TCDEM-8B4P-DYU	112095-5027
4	8	8	PNP	TCDEM-888P-DYU	112095-5028
4	16 User Configurable		User Configurable	TCDEM-8YX-DYU	112095-5038

*EtherNet/IP is a trademark of ODVA (Open Device Vendor Association)

EtherNet/IP*

No. of Power Pins	IO Configuration		Input Channel Type	Engineering No.	Standard Order No.
	Input	Output			
5	16		NPN	TCDEI-8DON-D1U	112095-5003
5	14	2	NPN	TCDEI-8C2N-D1U	112095-5004
5	12	4	NPN	TCDEI-8B4N-D1U	112095-5005
5	8	8	NPN	TCDEI-888N-D1U	112095-5006
5	16		PNP	TCDEI-8DOP-D1U	112095-5007
5	14	2	PNP	TCDEI-8C2P-D1U	112095-5008
5	12	4	PNP	TCDEI-8B4P-D1U	112095-5009
5	8	8	PNP	TCDEI-888P-D1U	112095-5010
5	16 User Configurable		User Configurable	TCDEI-8YYX-D1U	112095-5011
4	16		NPN	TCDEI-8DON-DYU	112095-5012
4	14	2	NPN	TCDEI-8C2N-DYU	112095-5013
4	12	4	NPN	TCDEI-8B4N-DYU	112095-5014
4	8	8	NPN	TCDEI-888N-DYU	112095-5015
4	16		PNP	TCDEI-8DOP-DYU	112095-5016
4	14	2	PNP	TCDEI-8C2P-DYU	112095-5017
4	12	4	PNP	TCDEI-8B4P-DYU	112095-5018
4	8	8	PNP	TCDEI-888P-DYU	112095-5019
4	16 User Configurable		User Configurable	TCDEI-8YYX-DYU	112095-5020

*EtherNet/IP is a trademark of ODVA (Open Device Vendor Association)

PROFINET IO

No. of Power Pins	IO Configuration		Input Channel Type	Engineering No.	Standard Order No.
	Input	Output			
5	16		NPN	TCDEP-8DON-D1U	112095-5029
5	16		PNP	TCDEP-8DOP-D1U	112095-5033
5	14	2	PNP	TCDEP-8C2P-D1U	112095-5034
5	16 User Configurable		User Configurable	TCDEP-8YYX-D1U	112095-5037

Brad® Common Industrial Protocol (CIP*) Safety Software Kit (Stack)

112115/112116/112117
DeviceNet* and EtherNet/IP*
Stack Development Kits



Molex demonstrates market leadership with the comprehensive CIP* Safety Stack software solution, allowing industrial-device manufacturers to embed CIP Safety Stack technology quickly and economically within their products.

Common Industrial Protocol (CIP) Safety is a protocol extension developed by the ODVA. The CIP Safety protocol offers a set of highly-integrated safety services which leverage the underlying communications stacks of the standard CIP networks to transport data from a source to a destination. CIP Safety allows end-users to implement safety systems in a more integrated, cost-effective manner. The Molex CIP Safety Software Kit (also called Stack) is offered as a tool kit, with the stack provided as modular "C" code that is pre-tested. The software allows a manufacturer of intelligent industrial products to implement the necessary safety-application layer that enables products to comply with the CIP Safety specification (Edition 2.1) from ODVA. The CIP Safety Stack is available for both DeviceNet* and EtherNet/IP*, and both are endorsed by Rockwell Automation under the Value Added Design Partner program.

The CIP Safety Stack is approved by TÜV for SIL3 applications and it has been conformance tested using the ODVA Conformance Test. Molex can support customers that request assistance with design implementation and/or guidance through TÜV approval.

Features and Benefits

- Meets IEC 61508, SIL3 ensuring international market acceptance
- Approved by TÜV and tested by ODVA means a high-quality solution for minimal project risk and faster time-to-market
- Pre-tested modular ANSI C code is easy to compile using standard compilers; faster time-to-market
- Molex engineers can support protocol-integration requests minimizing investment required for in-house resources
- Designed for use with other Molex/Brad offerings: hardware (DN4 network interface cards), software (DeviceNet or EtherNet/IP software stacks) which results in a complete CIP communication solution

Specifications

- ANSI C code is provided for the safety portion of the Stack (Compliant with CIP Safety Specification 2.1)
- ANSI C code for black-channel components (NET_CTRL_IO)
- Interface specification for high-integrity and black-channel environments
- Safety integration manual (including safety measure requirements)
- Optionally, modified standard CIP stacks (software/firmware) for DeviceNet (Slave) or EtherNet/IP (Adapter)
- Optionally, ANSI C code for the Platform Adaptation Layers (both safety and non-safety)
- Documentation required by certification bodies (TÜV, ODVA)
- Support during certification process of vendor's final product

Markets and Applications

- Industrial Device Manufacturers
 - I/O blocks
 - Valves
 - Drives
 - Complex machines (OEM)
- End-Users
 - Automotive
 - Consumer goods
 - Heavy industries

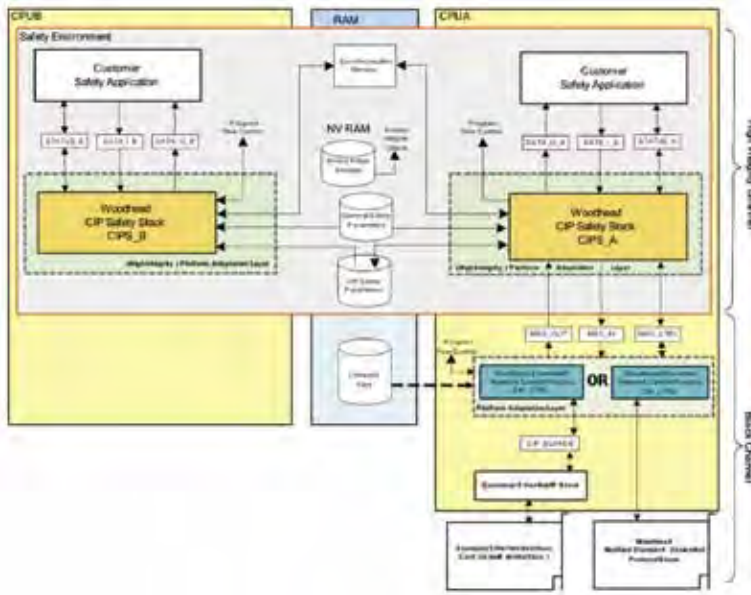

CIP* Safety Software Stack Concept for a Slave (Adapter) Application

Device Type	Network	Description	Engineering No.	Standard Order No.
Slave	DeviceNet	Stack Development Kit (Standard Source Code)	SDK-DNS-SAF	112115-0001
		Stack Development Kit (Source Code Obfuscation ¹)	SDK-DNS-SAF-O	112115-0002
		Royalty (per device)	SDK-DNS-SAF-L	112116-0001
Adapter	EtherNet/IP	Stack Development Kit (Standard Source Code)	SDK-EIP-ADP-SAF	112117-0001
		Stack Development Kit (Source Code Obfuscation ¹)	SDK-EIP-ADP-SAF-O	112117-0002
		Royalty (per device)	SDK-EIP-ADP-SAF-L	112116-0002
Slave and Adapter	DeviceNet and EtherNet/IP	Stack Development Kit (Standard Source Code)	SDK-DEP-SAP-SAF	112115-0003
		Stack Development Kit (Source Code Obfuscation ¹)	SDK-DEP-SAP-SAF-O	112115-0004
N/A	N/A	Engineering Support	SDK-CIP-EDS-SAF	112115-0005

*CIP, DeviceNet and EtherNet/IP are trademarks of ODVA, Inc.

¹ Source code obfuscation means that the "C" code is protected, but the compiler can process it

Brad® Direct-Link® Harsh Duty Ethernet Switches

112115/112105
Series 750 (5-port) and
780 (8-port)



As our world becomes more connected, an increasing number of manufacturers and installers are specifying Ethernet devices for their harsh applications. The Brad family of rugged connectivity products is a leading product line provider of Ethernet infrastructure for Molex.

The Molex Direct-Link, harsh-duty, Ethernet switches have been developed to allow customers to convert from traditional in-cabinet to on-machine mounting, moving the switch closer to the machine and thereby reducing cabling.

The Molex Ultra-Lock® system of connectors and cordsets complete the Direct-Link Harsh-Duty Switches line.

Available in 5-port and 8-port versions, the Molex durable switches with push/pull connectors save cabling and reduce installation time and cost compared with existing cabinet installations. They provide easier system maintenance and produce a seal when connected regardless of labor skill. The connections are tested to IP67 ratings to ensure operation through dust, pressure-wash and immersion in water. Mechanical keying and radial seals eliminate the risk for operator error commonly found in other systems.

Narrow dimensions are sized to fit standard machine extrusions for easy mounting. Auto-learning features make each unit truly plug-and-play, suitable for both the novice and expert in network setup.

Operating temperature ratings of -20 to +75° C ensure that networks linked using the harsh-duty switches can run in extreme environments.

Features and Benefits

- Ultra-Lock® Connection system—faster, simpler and more secure connections than any other system on the market
- NEMA 6 and IP67 rated environmental Protection— withstands dust, pressure-wash and submersion in water
- Operating temperature -20 to +75° C enables installation in extreme temperature applications
- 30mm and 60mm formats with standard hole patterns—allows use of standard machine extrusion members
- Auto-learning with no software or configuration required—plug-and-play capabilities means less-skilled labor is able to install systems

Characteristics and Performance

Switch Type: Unmanaged (Store and Forward)
Ports: 10BaseT/100BaseTx M12
Latency (10Mb): 16µs + frame time
Latency (100Mb): 5µs + frame time
Duplex Operation: Full or half
Mounting: Screw mount
Power Input: Redundant input terminals
Input Power: 2.0W max. (DRL-750), 2.4W max. (DRL-78x)
Voltage: 9-36VDC (continuous)
Isolation: 1500 VRMS 1 minute
Dimensions: 176 x 30 x 34 (DRL-750)
220 x 60 x 37 (DRL-78x)
Weight: 230g (DRL-750)
580g (DRL-78x)

Environmental

Humidity: 5–95% RH non condensing

References

Vibration: 7g (IEC68-2-29)
Shock: 50g (IEC68-2-29)
Electrical Safety: EN61010-1 (IEC61010)
EMI Emissions: EN55011 Class A (DRL-78x),
Class B (DRL-750)
EMC Immunity: EN61326, EN61000-4-4,
EN61000-4-5,
EN61000-4-2;
8Kv contact/16Kv Air (DRL-750)
4Kv contact/8Kv Air (DRL-78x)
UL: File number pending

Physical

Operating Temperature: -20 to +75° C
Storage Temperature: -40 to +85° C

Description	Ports (M12)	Power	Engineering No.	Standard Order No.
IP67 Fast Ethernet Unmanaged Switch	5	M12	DRL-750	112111-5001
IP67 Fast Ethernet Unmanaged Switch	8	Mini-Change® (5-pin)	DRL-780	112105-5002
IP67 Fast Ethernet Unmanaged Switch	8	Mini-Change (4-pin)	DRL-781	112105-5004

Brad® Direct-Link® In-Cabinet Ethernet Switches

112036

Series 200 and 300



A complete line of industrial Ethernet switches for managed or unmanaged applications.

Series 200—Unmanaged Switches

- Direct-Link Industrial Ethernet unmanaged switches provide enhanced performance allowing you to achieve real-time deterministic operation of your Ethernet network
- Plug-and-play—no configuration required
- Best value for reducing network collisions
- Choice of standard-duty (SD) plastic case or heavy-duty (HD) metal case designs

Series 300—Managed Switches

- Direct-Link Industrial Ethernet managed switches offer many features to meet your network management and diagnostic needs
- Advanced Network Management
 - Rapid Spanning Tree Protocol (RSTP) for fault-tolerant loops
 - VLAN (port and tag based) for traffic segregation
 - Message filtering to stop multi-cast storms (IGMP snooping)
 - Priority queuing for real-time performance (QoS)
 - Easy configuration via web, Telnet or CLI (Command-Line Interface)
- Comprehensive Network Diagnostics
 - RMON and port mirroring
 - SNMP agent v1, v2 and v3
 - All managed switches have a rugged metal case design

Features and Benefits

- 5-, 8-, 9- and 18-port configurations support both Copper and fiber wiring; 16-port models have Copper-only connections
- Unique ergonomic design with DIN rail or panel mount option using a dual-clip system for quick and easy installation
- Small footprint in IP30 or IP40 industrial package
- Supports all standard IEEE 802.3 protocols
- Redundant, dual-DC power inputs (managed switches only)

Certification

Vibration: IEC60068-2-6, -27 and -32
 Electrical Safety: UL 508, CSA C22.2/14, EN61010-1, CE
 Hazardous Locations: UL 1604, CSA C22.2/213 (Class I, Div 2, Groups) EN60079-15 (Zone 2, Category 3), CE (ATEX)
 EMC: FCC part 15, ICES-003, EN61006-2/4, CE

Specifications

Ethernet protocols supported:
 IEEE 802.3 protocols (IEEE 802.3, 802.3u, 802.3x)
 10/100 BaseT(x) Ports: Shielded RJ45
 10/100/1000 BaseT(x) Ports: Shielded RJ45 (18-port models only)
 10/100 Mbps (full duplex) fiber SC or ST connectors
 10/100/1000 Mbps (full duplex) LC connectors
 Auto-negotiating:
 10/100 Mbps auto-negotiation
 Auto-crossover (Auto-mdi/mdix): Supported on all ports
 Flow Control: Half or full duplex
 Ethernet Isolation: 1500 VRMS 1 minute
 Forwarding Mode: Store and forward
 Latency (Typical): 5 µsec (time to route a message from one port to another internally at 100 Mps)
 MAC Addresses: 1K or 2K
 Address Learning: Automatic
 Supply Voltage: 10–30V DC
 Power Consumption (Typical): 2–10 W (dependent on model)
 Power Saving: Automatic
 Mounting: DIN rail or panel direct

Environmental
 Humidity: 5 to 95% (non-condensing)

Physical
 Packaging: IP30 or IP40 protection
 Operating Temperature (Unmanaged Plastic Case): -10 to +60° C
 Operating Temperature (Unmanaged Metal Case): -40 to +85° C
 Operating Temperature (Managed Metal Case): -40 to +75° C
 Storage Temperature: -40 to +85° C

Industrial Ethernet Switch Product Description	Dimensions (W x H x D, mm)	Engineering No.	Standard Order No.
5-port, Unmanaged, Standard-Duty, 4 RJ-45 + 1 Multi-mode FX, SC connector, 10/100 Mbps	25.4 x 100.3 x 82.8	DRL-241P-MSC	112036-0043
5-port, Unmanaged, Standard-Duty, 4 RJ-45 + 1 Multi-mode FX, ST connector, 10/100 Mbps	25.4 x 100.3 x 82.8	DRL-241P-MST	112036-0044
5-port, Unmanaged, Standard-Duty, 5 RJ-45, 10/100 Mbps	25.4 x 100.3 x 82.8	DRL-250P	112036-0035
5-port, Unmanaged, Heavy-Duty, 5 RJ-45, 10/100 Mbps	27.1 x 132.1 x 106.9	DRL-250M	112036-0036
8-port, Unmanaged, Standard-Duty, 8 RJ-45, 10/100 Mbps	38.1 x 100.3 x 82.8	DRL-280P	112036-0037
8-port, Unmanaged, Heavy-Duty, 8 RJ-45, 10/100 Mbps	40.7 x 132.1 x 106.9	DRL-280M	112036-0038
5-port, Unmanaged, Standard-Duty, 8 RJ-45 + 1 Multi-mode FX, SC connector, 10/100 Mbps	25.4 x 100.3 x 82.8	DRL-281P-MSC	112036-0045
5-port, Unmanaged, Standard-Duty, 8 RJ-45 + 1 Multi-mode FX, ST connector, 10/100 Mbps	25.4 x 100.3 x 82.8	DRL-281P-MST	112036-0046
5-port, Managed, Heavy-Duty, 3 RJ-45 + 2 Multi-mode FX, SC connector, 10/100 Mbps, redundant power	27.1 x 132.1 x 106.9	DRL-332M-MSC	112036-0047
5-port, Managed, Heavy-Duty, 3 RJ-45 + 2 Multi-mode FX, ST connector, 10/100 Mbps, redundant power	27.1 x 132.1 x 106.9	DRL-332M-MST	112036-0048
5-port, Managed, Heavy-Duty, 3 RJ-45 + 2 Single Mode FX, SC connector, 10/100 Mbps, redundant power	27.1 x 132.1 x 106.9	DRL-332M-SSC	112036-0049
5-port, Managed, Heavy-Duty, 3 RJ-45 + 2 Single Mode FX, ST connector, 10/100 Mbps, redundant power	27.1 x 132.1 x 106.9	DRL-332M-SST	112036-0050
5-port, Managed, Heavy-Duty, 5 RJ-45, 10/100 Mbps, redundant power	27.1 x 132.1 x 106.9	DRL-350M	112036-0039
8-port, Managed, Heavy-Duty, 6 RJ-45 + 2 Multi-mode FX, SC connector, 10/100 Mbps, redundant power	40.7 x 132.1 x 106.9	DRL-362M-MSC	112036-0051
8-port, Managed, Heavy-Duty, 6 RJ-45 + 2 Multi-mode FX, ST connector, 10/100 Mbps, redundant power	40.7 x 132.1 x 106.9	DRL-362M-MST	112036-0052
8-port, Managed, Heavy-Duty, 6 RJ-45 + 2 Single-mode FX, SC connector, 10/100 Mbps, redundant power	40.7 x 132.1 x 106.9	DRL-362M-SSC	112036-0053
8-port, Managed, Heavy-Duty, 6 RJ-45 + 2 Single-mode FX, ST connector, 10/100 Mbps, redundant power	40.7 x 132.1 x 106.9	DRL-362M-SST	112036-0058
8-port, Managed, Heavy-Duty, 8 RJ-45, 10/100 Mbps, redundant power	40.7 x 132.1 x 106.9	DRL-380M	112036-0040
16-port, Managed, Heavy-Duty, 16 RJ-45, 10/100 Mbps	54.0 x 152.9 x 118.0	DRL-3F0M	112036-0041
18-port, Managed, Heavy-Duty, 18 RJ-45, 10/100 Mbps (ports 1-16), 10/100/1000 Mbps (ports 17-18)	73.1 x 152.9 x 118.0	DRL-3H0M	112036-0042
18-port, Managed, Heavy-Duty, 17 RJ-45 + 1 Multi-mode FX, LC connector, 10/100 Mbps (ports 1-16), 10/100/1000 Mbps (ports 17-18), redundant power	73.1 x 152.9 x 118.0	DRL-3H0M-1MLC	112036-0054
18-port, Managed, Heavy-Duty, 17 RJ-45 + 1 Single-mode FX, LC connector, 10/100 Mbps (ports 1-16), 10/100/1000 Mbps (ports 17-18), redundant power	73.1 x 152.9 x 118.0	DRL-3H0M-1SLC	112036-0055
18-port, Managed, Heavy-Duty, 16 RJ-45 + 2 Multi-mode FX, LC connector, 10/100 Mbps (ports 1-16), 10/100/1000 Mbps (ports 17-18), redundant power	73.1 x 152.9 x 118.0	DRL-3H0M-2MLC	112036-0056
18-port, Managed, Heavy-Duty, 16 RJ-45 + 2 Single-mode FX, LC conn, 10/100 Mbps (ports 1-16), 10/100/1000 Mbps (ports 17-18), redundant power	73.1 x 152.9 x 118.0	DRL-3H0M-2SLC	112036-0057

Industrial Ethernet Brad® RJ-Lnxx® RJ-45 Single-Ended Cordsets

130050

**Male, Pigtail
Straight**



Features and Benefits

- RJ-45 plug, combined with industrially proven form factor provides a secure robust connection that protects against the effects of vibration and accidental disconnection
- Category 5e compliant
- Several cable options available

ENS—Solid Core Cable

Physical

Cable: Solid core
 Conductors: 24 AWG solid bare Copper, 0.020" (0.510 mm)
 Insulation: 0.009" (0.229 mm) of Cellular Polyethylene 0.04" (1.00mm) nominal diameter
 Pair: Two insulated conductors twisted together, lay lengths varied between pairs to minimize cross talk
 Core: Four pairs cabled together
 Binder: Polyester tape, 20% overlay minimum
 Shield: Aluminum/Polyester tape, 20% overlay minimum
 Drain Wire: 24 AWG stranded (7/32") Tin-plated Copper
 Jacket:
 Black Polyurethane 0.025" (.635 mm) nominal thickness
 Operating Temperature: -20 to +80° C
 Wiring Sequence: Choice of TIA/EIA, 568A/B, or 10 Base-T

Electrical at 20° C

TIA/EIA Rating: Category 5e

ENP—Kevlar*-wrapped Cable

Physical

Cable: Proplex™ Kevlar-wrapped
 Conductors: 26 AWG stranded bare Copper
 Insulation: Color coded HFFR, halogen free, 0.035" (0.90mm) nominal diameter
 Pair: Cabled with Kevlar strength member and tape wrapped
 Core: Four pairs cabled together
 Shield: Inner—Aluminum mylar, 100% coverage
 Outer—Tinned Copper
 Operating Temperature: -70 to +105° C
 Jacket: Black Urethane 0.059" (1.50mm) nominal thickness
 Diameter: 0.287" (7.30 mm) nominal
 Wiring Sequence: Choice of TIA/EIA, 568A/B, or 10 Base-T

Electrical at 20° C

TIA/EIA Rating: Category 5

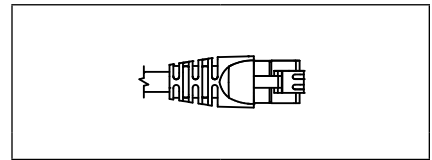

Male Straight Single-Ended

Cable Type	Cable Jacket	Wiring	Length	Engineering No.	Standard Order No.
Shielded Stranded Proplex Kevlar Wrapped (ENP)	PUR	10 Base-T (4 wire)	1.0m	ENP1305M010	130050-0105
Shielded Solid Core (ENS)	PVC	568A (8 wire)	1.0m	ENS2305M010	130050-0392
		568B (8 wire)		ENS3305M010	130050-0436

Note: Sales drawings for all standard order numbers are available on molex.com

*Kevlar is a trademark of DuPont

Configuration Code†
Build-a-Part Number

Meters	Length	Code
	1	M010
	2	M020
	5	M050
	10	M100

ENP1305M010

→ Wiring Option
→ Cable Option

†Once an engineering number is created using the configuration code, consult Molex tech support for information regarding any part numbers.

Industrial Ethernet Brad® RJ-Lnxx RJ-45 Double-Ended Cordsets

130050
**Male-Male Straight
Standard RJ-45**



Features and Benefits

- RJ-45 plug, combined with industrially proven form factor provides a secure robust connection that protects against the effects of vibration and accidental disconnection
- Category 5e compliant
- Several cable options available

ENS—Shielded Solid Core Cable

Physical

Cable: Solid core
 Conductors: 24 AWG solid bare Copper, 0.020" (0.510mm)
 Insulation: 0.009" (0.229mm) of cellular polyethylene
 0.04" (1.0mm) nominal diameter
 Pair: Two insulated conductors twisted together, lay lengths varied between pairs to minimize cross talk
 Core: Four pairs cabled together
 Binder: Polyester tape, 20% overlay minimum
 Shield: Aluminum/polyester tape, 20% overlay minimum
 Drain Wire: 24 AWG stranded (7/32") Tin-plated Copper
 Jacket: Black polyurethane 0.025" (.635mm) nominal thickness
 Operating Temperature: -20 to +80° C
 Diameter: 0.245" (6.223mm) nominal
 TIA/EIA Rating: Category 5e

ENQ—Unshielded Stranded Cable

Physical

Cable: Stranded
 Conductors: 24 AWG stranded Tinned Copper
 Insulation: Polyolefin 0.037" (0.94mm) nominal diameter
 Pair: Two insulated conductors twisted together, lay lengths varied between pairs to minimize cross talk
 Core: Four pairs cabled together
 Binder: Polyester tape, 20% overlay minimum
 Operating Temperature: -20 to +80° C
 Jacket: PVC 0.025" (0.635mm) nominal thickness
 Diameter: 0.220" (5.588mm) nominal
 TIA/EIA Rating: Category 5e

ENP—Shielded Standard Proplex™ Kevlar*-wrapped Cable

Physical

Cable: Proplex Kevlar-wrapped
 Conductors: 26 AWG stranded bare Copper
 Insulation: Color coded HFFR, halogen free,
 0.035" (0.90mm) nominal diameter
 Pair: Cabled with Kevlar strength member and tape wrapped
 Core: Four pairs cabled together
 Shield: Inner—Aluminum mylar, 100% coverage
 Outer—Tinned Copper braid, 80% coverage
 Operating Temperature: -70 to +105° C
 Jacket: Black urethane 0.059" (1.5mm) nominal thickness
 Diameter: 0.287" (7.3mm) nominal
 TIA/EIA Rating: Category 5e

ENV—Shielded Solid Core

Physical

Cable: Solid core
 Conductors: 24 AWG solid bare Copper, 0.020" (0.510mm)
 Insulation: Polyethylene, 0.042" (1.07mm) nominal diameter
 Pair: Two insulated conductors twisted together, lay lengths varied between pairs to minimize cross talk
 Core: Four pairs cabled together
 Binder: Polyester tape, 20% overlay minimum
 Shield: Aluminum/polyester tape
 Drain Wire: 24 AWG Tin Copper matt polyurethane
 Jacket: Black Polyurethane UV stable, 0.0244" (0.620mm) nominal thickness
 Diameter: 0.244" (6.200mm) nominal
 Operating Temperature: -20 to 60° C
 Wiring Sequence: Choice of TIA/EIA 568A/B or 10 Base-T
 TIA/EIA Rating: Category 5e

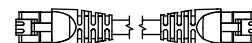

Cable Type	Cable Jacket	Wire Size AWG	Wiring	Length	Male Straight-to-Male Straight	
					Engineering No.	Standard Order No.
Shielded Stranded Proplex Kevlar-wrapped (ENP)	PUR With Kevlar Wrap	26	10 Base-T (4 wire)	1.0m	ENP1335M010	130050-0107
			568A (8 wire)		ENP2335M010	130050-0150
			568B (8 wire)		ENP3335M010	130050-0457
Shielded Solid Core (ENS)	PUR	24	10 Base-T (4 wire)	1.0m	ENS1335M010	130050-0324
			568A (8 wire)		ENS2335M010	130050-0394
			568B (8 wire)		ENS3335M010	130050-0503
Shielded Solid Core (ENV)	PUR	24	568B (8 wire)	1.0m	ENV3335M010	130050-0512
Unshielded Stranded (ENQ)	PVC	24	568B (8 wire)	1.0m	ENQ3335M010	130050-0507

Note: Sales drawings for all standard order numbers are available on molex.com
 *Kevlar is a trademark of DuPont

Configuration Code*
Build-a-Part Number

	Length	Code
Meters	2	M020
	5	M050
	10	M100

ENP1335M010

→ Wiring Option
→ Cable Option

*Once an engineering number is created using the configuration code, consult Molex tech support for information regarding any part numbers.

Industrial Ethernet Brad® Standard RJ-45 to RJ-45 Cable Assembly Unshielded PVC

130048
Male Plug-to-Male Plug
Straight-Wired



Features and Benefits

- RJ-45 plug combined with industrially proven form factor provides a secure robust connection that protects against the effects of vibration and accidental disconnection
- Category 5e compliant

Reference Information

UL File No.: E200650

Physical

RJ-45 Plug: Clear Polycarbonate
Boot: PVC
Operating Temperature: -20 to +75° C

Environmental

Protection: IP20

Cable

03—Unshielded PVC

Conductors: 24 AWG stranded tinned Copper wire
Pair: Two pair UTP patch cable
Outside Diameter: 0.250" (5.60mm) nominal
Jacket Material: Teal PVC
Cable Properties: Sun and oil resistant
Inner Material Insulation: HDPE
Certification: UL type CMR, Cec (UL) type CMR
TIA/EIA Rating: Category 5e
Operating Temperature: -40 to +75° C

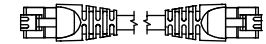

Male Straight-to-Male Straight

Wiring	Cable Type	Cable Jacket	Wire Size AWG	Length	Engineering No.	Standard Order No.
10 Base-T (4 wire)	Unshielded Stranded	PVC	4/24	1.0m (3.28')	E66A06003M010	130048-0031

Note: Sales drawings for all standard order numbers are available on molex.com

Configuration Code*
Build-a-Part Number

	Length	Code
Meters	1	M010
	2	M020
	5	M050
	10	M100

E66A06003M010

→ Cable Option
→ Wiring Option

*Once an engineering number is created using the configuration code, consult Molex tech support for information regarding any part numbers.

Industrial Ethernet Brad® RJ-Lnxx® RJ-45 Single-Ended Cordsets

130050
Threaded
Male
Straight



Features and Benefits

- RJ-45 plug, combined with industrially proven form factor provides a secure robust connection that protects against the effects of vibration and accidental disconnection
- Category 5e compliant
- Several cable options available
- Achieves IEC IP67 rates seal when mated with an RJ-Lnxx receptacle

ENS—Shielded Solid Core Cable

Physical

Cable: Solid Core
 Conductors: 24 AWG solid bare Copper, 0.020" (0.510mm)
 Insulation: 0.009" (0.229mm) of cellular polyethylene
 0.04" (1.0mm) nominal diameter
 Pair: Two insulated conductors twisted together, lay lengths varied between pairs to minimize cross talk
 Core: Four pairs cabled together
 Binder: Polyester tape, 20% overlay minimum
 Shield: Aluminum/Polyester tape, 20% overlay minimum
 Drain Wire: 24 AWG stranded (7/32") Tin-plated Copper
 Jacket: Black Polyurethane 0.025" (.635mm) nominal thickness
 Operating Temperature: -20 to +80° C
 Diameter: 0.245" (6.223mm) nominal
 TIA/EIA Rating: Category 5e

ENQ—Unshielded Stranded Cable

Physical

Cable: Stranded
 Conductors: 24 AWG stranded tinned Copper
 Insulation: Polyolefin 0.037" (0.94mm) nominal diameter
 Pair: Two insulated conductors twisted together, lay lengths varied between pairs to minimize cross talk
 Core: Four pairs cabled together
 Binder: Polyester tape, 20% overlay minimum
 Operating Temperature: -20 to +80° C
 Jacket: PVC 0.025" (0.635mm) nominal thickness
 Diameter: 0.220" (5.588mm) nominal
 TIA/EIA Rating: Category 5e

ENP—Shielded Standard Proplex™ Kevlar*-Wrapped Cable

Physical

Cable: Proplex Kevlar-wrapped
 Conductors: 26 AWG stranded bare Copper
 Insulation: Color coded HFFR, Halogen free, 0.035" (0.90mm) nominal diameter
 Pair: Cabled with Kevlar strength member and tape-wrapped
 Core: Four pairs cabled together
 Shield: Inner—Aluminum Mylar, 100% coverage
 Outer—Tinned Copper braid, 80% coverage
 Operating Temperature: -70 to +105° C
 Jacket: Black Urethane 0.059" (1.50mm) nominal thickness
 Diameter: 0.287" (7.30mm) nominal
 TIA/EIA Rating: Category 5e

ENV—Shielded Solid Core

Physical

Cable: Solid core
 Conductors: 24 AWG solid bare Copper, 0.020" (0.510mm)
 Insulation: Polyethylene, 0.042" (1.07mm) nominal diameter
 Pair: Two insulated conductors twisted together, lay lengths varied between pairs to minimize cross talk
 Core: Four pairs cabled together
 Binder: Polyester tape, 20% overlay minimum
 Shield: Aluminum/Polyester tape
 Drain Wire: 24 AWG Tin Copper matt Polyurethane
 Jacket: Black Polyurethane UV stable, 0.0244" (0.620mm) nominal thickness
 Diameter: 0.244" (6.200mm) nominal
 Operating Temperature: -20 to 60° C
 Wiring Sequence: Choice of TIA/EIA 568A/B or 10 Base-T
 TIA/EIA Rating: Category 5e

Cable Type	Cable Jacket	Wire Size AWG	Wiring	Length	Male Straight	
					Engineering No.	Standard Order No.
Shielded Stranded Proplex Kevlar-wrapped (ENP)	PUR Kevlar-wrapped	26	10 Base-T (4 wire)	1.0m	ENP1105M010	130050-0071
			568A (8 wire)		ENP2105M010	130050-0112
			568B (8 wire)		ENP3105M010	130050-0162
Shielded Solid Core (ENS)	PUR	24	10 Base-T (4 wire)	1.0m	ENS1105M010	130050-0277
			568A (8 wire)		ENS2105M010	130050-0328
			568B (8 wire)		ENS3105M010	130050-0408
Shielded Solid Core (ENV)	PUR	24	568B (8 wire)	1.0m	ENV3105M010	130050-8023
Unshielded Stranded (ENQ)	PVC	24	568B (8 wire)	1.0m	ENQ3105M010	130050-0506

Note: Sales drawings for all standard order numbers are available on molex.com
 *Kevlar is a trademark of DuPont

Configuration Code†
Build-a-Part Number

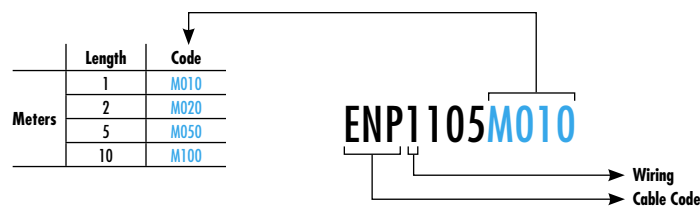

†Once an engineering number is created using the configuration code, consult Molex tech support for information regarding any part numbers.

Industrial Ethernet Brad® RJ-Lnxx® RJ-45 Double-Ended Cordsets

130050

Threaded Male-Male Straight RJ-45 (Industrial)-to- RJ-45 (Industrial) and RJ-45 (Industrial)-to- RJ-45 (Standard)



Features and Benefits

- RJ-45 plug, combined with industrially proven form factor provides a secure robust connection that protects against the effects of vibration and accidental disconnection
- Category 5e compliant
- Several cable options available
- Achieves IEC IP67 rates seal when mated with an RJ-Lnxx® receptacle

ENS—Shielded Solid Core Cable

Physical

Cable: Solid Core
 Conductors: 24 AWG solid bare Copper, 0.020" (0.510mm)
 Insulation: 0.009" (0.229mm) of cellular polyethylene
 0.04" (1.0mm) nominal diameter
 Pair: Two insulated conductors twisted together, lay lengths varied between pairs to minimize cross talk
 Core: Four pairs cabled together
 Binder: Polyester tape, 20% overlay minimum
 Shield: Aluminum/Polyester tape, 20% overlay minimum
 Drain Wire: 24 AWG stranded (7/32") Tin-plated Copper
 Jacket: Black Polyurethane 0.025" (.635mm) nominal thickness
 Operating Temperature: -20 to +80° C
 Diameter: 0.245" (6.223mm) nominal
 TIA/EIA Rating: Category 5e

ENQ—Unshielded Stranded Cable

Physical

Cable: Stranded
 Conductors: 24 AWG stranded tinned Copper
 Insulation: Polyolefin 0.037" (0.94mm) nominal diameter
 Pair: Two insulated conductors twisted together, lay lengths varied between pairs to minimize cross talk
 Core: Four pairs cabled together
 Binder: Polyester tape, 20% overlay minimum
 Operating Temperature: -20 to +80° C
 Jacket: PVC 0.025" (0.635mm) nominal thickness
 Diameter: 0.220" (5.588mm) nominal
 TIA/EIA Rating: Category 5e

ENP—Shielded Standard Proplex™ Kevlar®-Wrapped Cable

Physical

Cable: Proplex Kevlar-wrapped
 Conductors: 26 AWG stranded bare Copper
 Insulation: Color coded HFFR, Halogen free, 0.035" (0.90mm) nominal diameter
 Pair: Cabled with Kevlar strength member and tape wrapped
 Core: Four pairs cabled together
 Shield: Inner—Aluminum Mylar, 100% coverage
 Outer—Tinned Copper Braid: 80% coverage
 Operating Temperature: -70 to +105° C
 Jacket: Black Urethane 0.059" (1.5mm) nominal thickness
 Diameter: 0.287" (7.3mm) nominal
 TIA/EIA Rating: Category 5e

ENV—Shielded Solid Core

Physical

Cable: Solid core
 Conductors: 24 AWG solid bare Copper, 0.020" (0.510mm)
 Insulation: Polyethylene, 0.042" (1.07mm) nominal diameter
 Pair: Two insulated conductors twisted together, lay lengths varied between pairs to minimize cross talk
 Core: Four pairs cabled together
 Binder: Polyester tape, 20% overlay minimum
 Shield: Aluminum/Polyester tape
 Drain Wire: 24 AWG Tin Copper matt Polyurethane
 Jacket: Black Polyurethane UV stable, 0.0244" (0.620mm) nominal thickness
 Diameter: 0.244" (6.200mm) nominal
 Operating Temperature: -20 to 60° C
 Wiring Sequence: Choice of TIA/EIA 568A/B or 10 Base-T
 TIA/EIA Rating: Category 5e

RJ-Lnxx-to-RJ-45 RJ-Lnxx RJ-45 Male, Double-Ended

Cable Type	Cable Jacket	Wire Size AWG	Wiring	Length	Male Straight Industrial-to-Industrial		Male Straight Industrial-to-Standard	
					Engineering No.	Standard Order No.	Engineering No.	Standard Order No.
Shielded Stranded Proplex Kevlar-wrapped (ENP)	PUR Kevlar-wrapped	26	10 Base-T (4 wire)	1.0m	ENP1115M010	130050-0076	ENP1135M010	130050-0093
			568A (8 wire)		ENP2115M010	130050-0122	ENP2135M010	130050-0140
			568B (8 wire)		ENP3115M010	130050-0170	ENP3135M010	130050-8036
Shielded Solid Core (ENS)	PUR	24	10 Base-T (4 wire)	1.0m	ENS1115M010	130050-0284		
			568A (8 wire)		ENS2115M010	130050-0336	ENS2135M010	130050-0371
			568B (8 wire)		ENS3115M010	130050-0412	ENS3135M010	130050-0429
Shielded Solid Core (ENV)	PUR	24	568B (8 wire)	1.0m	ENV3115M010	130050-8025	ENV3135M010	130050-8029
Unshielded Stranded (ENQ)	PVC	24	568B (8 wire)	1.0m	ENQ3115M010	130050-0251	ENQ3135M010	130050-0262

Note: Sales drawings for all standard order numbers are available on molex.com

*Kevlar is a trademark of DuPont

Configuration Code†
Build-a-Part Number

	Length	Code
Meters	1	M010
	2	M020
	5	M050
	10	M100

ENP1115M010

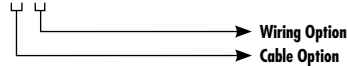

†Once an engineering number is created using the configuration code, consult Molex tech support for information regarding any part numbers.

Industrial Ethernet Brad® RJ-Lnxx® RJ-45 Sealed Receptacles

130053/130055

Female
Panel Mount
External Thread
Straight



Features and Benefits

- Simple field termination of cable using a standard punchdown tool
- Category 5e compliant
- Can be used with TIA 568A or 568B wiring sequences
- Color-coded block simplifies field wiring
- Achieves IEC IP67 rated seal when mated with RJ-Lnxx cordset—but also compatible with commercial RJ-45 patch cords

Environmental

Protection: IEC IP67
TIA/EIA Rating: Category 5e compliant

Physical

O-Ring Material: Viton®
Insert Material: Acrylonitrile-Butadiene-Styrene (ABS)
Overmold Material: Polyurethane
Coupling Nut Material: Acrylonitrile-Butadiene-Styrene (ABS)
Shell Material: Acrylonitrile-Butadiene-Styrene (ABS)
Knockout Hole: 1.063
Thread Size: UNC 1" - 14 UNC
Panel Thickness: .125" maximum with gasket, .187" maximum without gasket, .062" minimum
Operating Temperature: -20 to +80° C
Return Loss: 5 dB at 100 MHz

RJ-45 Jack

Plating: 50 μm of Gold over 100 μm of Nickel
Current Rating: 1.5A
Voltage Rating: 125V DC

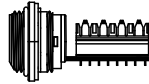

Face View	Description	Female Straight	
		Engineering No.	Standard Order No.
	RJ-45 Receptacle W/110 Punchdown Termination	ENDR2FB5	130053-0002

Note: Sales drawings for all standard order numbers are available on molex.com.
Viton® is a registered trademark of E.I. DuPont De Nemours and Company.

Industrial Ethernet Brad® RJ-Lnxx® RJ-45 Sealed Receptacles

130053/130055

**Female
Straight
Panel Mount
External Thread**



Features and Benefits

- Ideal for OEMs looking to incorporate a sealed, robust connection into their field device
- Category 5 compliant
- Short depths for space constrained applications
- Achieves IEC IP67 rated seal when mated with an RJ-Lnxx cordset—but also compatible with commercial RJ-45 patch cords

Environmental

Protection: IEC IP67
TIA/EIA Rating: Category 5 compliant

Physical

O-Ring Material: Viton®
Insert Material: Acrylonitrile-Butadiene-Styrene (ABS)
Overmold Material: Polyurethane
Coupling Nut Material: Acrylonitrile-Butadiene-Styrene (ABS)
Shell Material: Acrylonitrile-Butadiene-Styrene (ABS)
Knockout Hole: 1.063
Thread Size: UNC 1" - 14 UNC
Panel Thickness: .125" maximum with gasket,
.187" maximum without gasket,
.062" minimum

Operating Temperature: -20 to +80° C
Return Loss: 5 dB at 100 MHz

RJ-45 Jack

Plating: 50 μm of Gold over 100 μm of Nickel
Current Rating: 1.5A
Voltage Rating: 125V DC

Face View	Description	Female Straight	
		Engineering No.	Standard Order No.
	Direct PC Board Mount Receptacle	ENPR1FF5	130053-0004

Note: Sales drawings for all standard order numbers are available on molex.com.
Viton® is a registered trademark of E.I. DuPont De Nemours and Company.

Industrial Ethernet Brad® RJ-Lnxx® RJ-45 Sealed Receptacles

130053/130055

Female, Male
Straight
Panel Mount
External Thread



Features and Benefits

- Highly flexible solution for OEMs or end users looking to incorporate a sealed, robust receptacle into their field device or control panel
- Achieves IEC IP67 rated seal when mated with RJ-Lnxx cordset—but also compatible with commercial RJ-45 patch cords

Environmental

Protection: IEC IP67

TIA/EIA Rating: Not rated as additional customer termination is required

Physical

O-Ring Material: Viton®

Insert Material: Acrylonitrile-Butadiene-Styrene (ABS)

Overmold Material: Polyurethane

Coupling Nut Material: Acrylonitrile-Butadiene-Styrene (ABS)

Shell Material: Acrylonitrile-Butadiene-Styrene (ABS)

Knockout Hole: 1.063

Thread Size: UNC 1" - 14 UNC

Panel Thickness: .125" maximum with gasket,
.187" maximum without gasket,
.062" minimum

Operating Temperature: -20 to +80° C

Return Loss: 5 dB at 100 MHz

RJ-45 Jack

Plating: 50 μm of Gold over 100 μm of Nickel

Current Rating: 1.5A

Voltage Rating: 125V DC

Face View	Description	Female Straight	
		Engineering No.	Standard Order No.
	Receptacle with PC Board	ENSR1FB5	130055-0016
	Receptacle with PC and 12" of Cable (10 Base-T)	ENSR1FB5M010	130055-0020

Note: Sales drawings for all standard order numbers are available on molex.com.
Viton® is a registered trademark of E.I. DuPont De Nemours and Company.

Configuration Code*
Build-a-Part Number

	Length	Code
Meters	1	M010
	2	M020
	5	M050
	10	M100

ENSR1FB5M010

*Once an engineering number is created using the configuration code, consult Molex tech support for information regarding any part numbers.

Industrial Ethernet Brad® RJ-Lnxx® RJ-45 Sealed Receptacles

130055/130058

Female
Bulkhead Pass-Through
Straight
External Thread



Features and Benefits

- Easy method for bringing an Ethernet connection in from a harsh environment to an industrial enclosure
- Category 5e compliant
- Achieves IEC IP67 rated seal when mated with RJ-Lnxx cordset—but also compatible with commercial RJ-45 patch cords

Environmental

Protection: IEC IP67
TIA/EIA Rating: Category 5e

Physical

O-Ring Material: Viton®
Insert Material: ABS
Overmold Material: Polyurethane
Coupling Nut Material: ABS
Shell Material: ABS
Knockout Hole: 1.063
Thread Size: UNC 1" - 14 UNC
Panel Thickness: .125" max. with gasket,
.187" max. without gasket,
.062" min.
Operating Temperature: -20 to +80° C
Return Loss: 5 dB at 100 Mhz

RJ-45 Jack

Plating: 50 μm of Gold over 100 μm of Nickel
Current Rating: 1.5A
Voltage Rating: 125V DC

RJ-11 Jack

Plating: 50 μm of Gold over 100 μm of Nickel
Current Rating: 1.5A
Voltage Rating: 125V DC

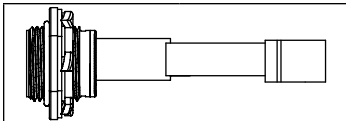

Face View	Description	Female Straight	
		Engineering No.	Standard Order No.
	RJ-11 Bulkhead Pass-Through Receptacles with Backside Jack	ENSP6F5	130055-0014
	RJ-45 Bulkhead Pass-Through Receptacles with 12" Male RJ-45 Patch Cord	ENSP1F5M010	130055-0005
	RJ-45 Bulkhead Pass-Through Receptacles with Backside Jack	ENSP1F5	130055-0001

Note: Sales drawings for all standard order numbers are available on molex.com.
Viton® is a registered trademark of E.I. DuPont De Nemours and Company.

Configuration Code*
Build-a-Part Number

	Length	Code
Meters	1	M010
	2	M020
	5	M050
	10	M100

ENSP1F5M010

*Once an engineering number is created using the configuration code, consult Molex tech support for information regarding any part numbers.

Industrial Ethernet Brad® RJ-Lnxx® RJ-45 Sealed Receptacles

130058

Threaded Interconnect

Features and Benefits

- Allows either molded or field attachable male connectors to be mated together, extending overall system length
- Two M40 nylon lock nuts and threaded barrel allow the interconnected to be positively fixed to a panel or enclosure wall

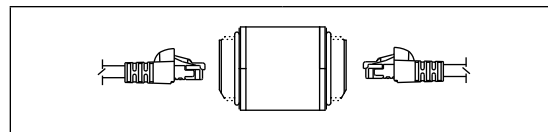

Face View (Female)	Description	Female Straight	
		Engineering No.	Standard Order No.
	In-Line—Interconnect	RJBG16821	130058-0057
	Threaded—Interconnect	RJBG17946	130058-0059

Industrial Ethernet Brad® RJ-Lnxx® RJ-45 Sealed Field Attachable Connectors

130057
Female
Straight



Features and Benefits

- Create an industrial Ethernet cordset in the field using standard crimp tools
- Achieves IEC IP67 rated seal when mated with an RJ-Lnxx receptacle

Physical

O-Ring Material: Viton®
Insert Material: Acrylonitrile-Butadiene-Styrene (ABS)
Overmold Material: Polyurethane
Coupling Nut Material: Acrylonitrile-Butadiene-Styrene (ABS)
Shell Material: Acrylonitrile-Butadiene-Styrene (ABS)
Thread Size: UNC 1.00–14.00"
Operating Temperature: -20 to +80° C

Environmental

Protection: IEC IP67

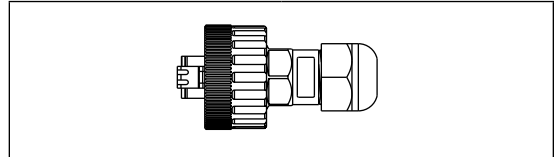

Description	Engineering No.	Standard Order No.
RJ-45 Connector (for Stranded Cable)	ENQAM315	130057-0001
RJ-45 Connector (for Solid Cable)	ENSAM315	130057-0003

Note: Sales drawings for all standard order numbers are available on molex.com.
Viton® is a registered trademark of E.I. DuPont De Nemours and Company.

Industrial Ethernet Brad® RJ-Lnxx® RJ-45 Sealed Accessories

130058
Female, Male
Closure Caps



Features and Benefits

- Attaches to RJ-Lnxx receptacles to provide an IEC IP65 rated seal for instances when a cordset is not mated

Physical

Material: Protective Cap—PA6 Nylon GF (UV Stabilized)
Lanyard—EPDM Rubber
Thread Size: UNC 1.00–14.00"
Operating Temperature: -20 to +80° C

Environmental

Protection: IEC IP65 (65-0300), IP67 (67-0300)

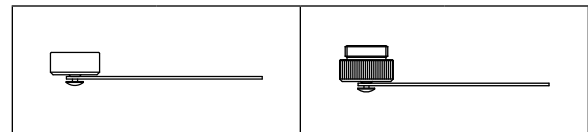

Type	Description	Female		Male	
		Engineering No.	Standard Order No.	Engineering No.	Standard Order No.
Cap	IP65 Rated	65-0300	130058-0033	65-0301	130058-0034
Cap and Lanyard	IP67 Rated	67-0300	130058-0035	67-0301	130058-0036

Note: Sales drawings for all standard order numbers are available on molex.com

Industrial Ethernet Brad® Sealed RJ-45 Overmolded Single-Ended Cordsets

84702 Bayonet Style RJ-45 Plug



Features and Benefits

- One sealing surface reduces chance of failure
- IP67 and NEMA 6P ratings ensure cable assemblies for water and dust tight functional integrity
- Bayonet style latching provides audible and tactile confirmation of positive mating
- Category 5e specified provides high data transmission speeds
- Overmolded cable assemblies allow for faster installation

Reference Information

Packaging: Bag
Mates With: 84700 and 84702
Designed In: Inches

Electrical

Voltage: 150V AC
Current: 1.5A
Contact Resistance: 20 milliohms max.
Dielectric Withstanding Voltage:
Adjacent Contacts—1000V AC
Contacts to Ground—1500V AC
Insulation Resistance: 500 Megohms min.
Type: Category 5e
Transmission Performance: Category 5e
RJ-45 Connection Interface: TIA/EIA-568-B
Shielding Effectiveness: 20 dB min.

Mechanical

Durability: 200 mating cycles min.
Coupling Ring Destructive Torque: 2.26Nm (20 in. lb)
or more

Physical

Overmolded Body: PVC, black
Coupling Ring: PBT, black
Holder: PBT, black
Wedge: PBT, black
Gasket Seal: Nitrile, black
Contact: Phosphor Bronze
Plating: Contact Area—1.27µm (50µ") Gold
Underplating—Nickel
Operating Temperature: -40 to +85° C

Length	Lead-free	Order No.
6.10m (20.00')	Yes	84702-3020

Industrial Ethernet Brad® Sealed RJ-45 Overmolded Double-Ended Cordsets

84702

**Bayonet Style RJ-45
Plug-to-Bayonet Style
RJ-45 Plug**



Features and Benefits

- One sealing surface reduces chance of failure
- IP67 and NEMA 6P ratings ensure cable assemblies are water and dust tight for functional integrity
- Bayonet style latching provides audible and tactile confirmation of positive mating
- Category 5e specified provides high data transmission speeds
- Overmolded cable assemblies allow for faster installation

Reference Information

Packaging: Bag
Mates With: 84700 and 84702
Designed In: Inches

Electrical

Voltage: 150V AC
Current: 1.5A
Contact Resistance: 20 milliohms max.
Dielectric Withstanding Voltage:
Adjacent Contacts—1000V AC
Contacts to Ground—1500V AC
Insulation Resistance: 500 Megohms min.
Transmission Performance: Category 5e
RJ-45 Connection Interface: TIA/EIA-568-B
Shielding Effectiveness: 20 dB min.

Mechanical

Durability: 200 mating cycles min.
Coupling Ring Destructive Torque: 2.26Nm (20 in. lb)
or more

Physical

Overmolded Body: PVC, black
Coupling Ring: PBT, black
Holder: PBT, black
Wedge: PBT, black
Gasket Seal: Nitrile, black
Contact: Phosphor Bronze
Plating: Contact Area—1.27 μ m (50 μ in) Gold
Underplating—Nickel
Operating Temperature: -40 to +85° C

Length	Lead-free	Order No.
0.91m (3.00')	Yes	84702-1003
1.83m (6.00')		84702-1006
3.00m (10.00')		84702-1010
6.10m (20.00')		84702-1020

Industrial Ethernet Brad® Sealed RJ-45 Overmolded Double-Ended Cordsets

84702

**Bayonet Style RJ-45
Plug-to-Standard RJ-45 Plug**



Features and Benefits

- One sealing surface reduces chance of failure
- IP67 and NEMA 6P ratings ensure cable assemblies are water- and dust-tight for functional integrity
- Bayonet style latching provides audible and tactile confirmation of positive mating
- Category 5e specified provides high data transmission speeds
- Overmolded cable assemblies allow for faster installation

Reference Information

Packaging: Bag
Mates With: 84700 and 84702
Designed In: Inches

Electrical

Voltage: 150V AC
Current: 1.5A
Contact Resistance: 20 milliohms max.
Dielectric Withstanding Voltage:
Adjacent Contacts—1000V AC
Contacts to Ground—1500V AC
Insulation Resistance: 500 Megohms min.
Transmission Performance: Category 5e
RJ-45 Connection Interface: TIA/EIA-568-B
Shielding Effectiveness: 20 dB min.

Mechanical

Durability: 200 mating cycles min.
Coupling Ring Destructive Torque: 2.26Nm (20 in. lb)
or more

Physical

Overmolded Body: PVC, black
Coupling Ring: PBT, black
Holder: PBT, black
Wedge: PBT, black
Gasket Seal: Nitrile, black
Contact: Phosphor Bronze
Plating: Contact Area—1.27 μ m (50 μ in) Gold
Underplating—Nickel
Operating Temperature: -40 to +85° C

Length	Lead-free	Order No.
0.91m (3.00')	Yes	84702-2003
2.13m (7.00')		84702-2007
3.00m (10.00')		84702-2010
3.66m (12.00')		84702-2012
4.57m (15.00')		84702-2015
6.10m (20.00')		84702-2020
6.40m (21.00')		84702-2021

Industrial Ethernet Brad® Sealed RJ-45 Receptacles

84702

Bayonet Style PCB Mount and Punchdown Panel Mount



PCB Mount

Punchdown Panel Mount

Features and Benefits

- One sealing surface reduces chance of failure
- Bayonet style latching provides audible and tactile confirmation of positive mating
- Punchdown version supports simple IDC termination

Reference Information

Packaging: Bag
Mates With: 84700 and 84702
Designed In: Inches

Electrical

Voltage: 150V AC
Current: 1.5A
Contact Resistance: 20 milliohms max.
Dielectric Withstanding Voltage:
Adjacent Contacts—1000V AC
Contacts to Ground—1500V AC
Insulation Resistance: 500 Megohms min.
Transmission Performance: Category 5e
RJ-45 Connection Interface: TIA/EIA-568-B
Shielding Effectiveness: 20 dB min.

Mechanical

Durability: 200 mating cycles min.
Lock Nut Destructive Torque: 2.71Nm (24 in. lb)

Physical

Receptacle Housing: PBT, black
Lock Nut: Polyamide 6/6, black
Panel Gasket: Neoprene, black
Punchdown Block: Thermoplastic, white
Wire Range (Punchdown Receptacle):
22 to 26 AWG solid and stranded, limiting outside diameter 1.40mm (.055")
Operating Temperature: -40 to +85° C

Description	Lead-free	Standard Order No.
PCB Mount Receptacle	Yes	84702-0005
Punchdown Panel Mount Receptacle		84702-0006
PCB Mount Receptacle, Potted		84702-0007
Punchdown Panel Mount Receptacle, Potted		84702-0008
Punchdown with 100 Ohm Resistors		84702-0009

Industrial Ethernet Brad® Sealed RJ-45 Bulkhead Pass-Through Receptacle

84700

Bayonet Style Panel Mount



Features and Benefits

- Back-to-back RJ-45 pass-through brings ethernet connectivity into a control cabinet and eliminates need for conduit entry
- Bayonet style latching provides audible and tactile confirmation of positive mating
- Meets ODVA/EtherNet™ IP specification

Reference Information

Packaging: Bag
Designed in: Inches
Mates With: 84700 and 84702
Waterproof: Meets requirements of IP67 and NEMA 6P for water tightness

Electrical

Voltage: 150V AC
Current: 1.5A
Contact Resistance: 20 milliohms max.
Insulation Resistance: 500 Megohms min.
Transmission Performance: Category 5e
RJ-45 Connection Interface: TIA/EIA-568-B
Shielding Effectiveness: 20 dB min.
Return Loss: 5 dB at 100MHz

Mechanical

Durability: 500 mating cycles min.

Physical

Receptacle Housing: PBT, black
Panel Gasket: Neoprene, black
Lock Nut: Steel
Plating: Lock Nut—Zinc
Operating Temperature: -40 to +85° C

Description	Lead-free	Standard Order No.
Panel Mount Receptacle	Yes	84700-0001

*EtherNet IP and DeviceNet are trademarks of the Open DeviceNet Vendor Association.

Industrial Ethernet Brad® Sealed RJ-45 Field Wireable Connectors

84700



Features and Benefits

- One sealing surface reduces chance of failure
- IP67 and NEMA 6P ratings ensure cable assemblies are water- and dust-tight for functional integrity
- Bayonet style latching provides audible and tactile confirmation of positive mating
- Superior strain relief
- Easy termination allows custom length cable to be made in the field
- Compatible with shielded and unshielded cable
- Meets ODVA/EtherNet™ IP* specification

Reference Information

Packaging: Bag
Mates With: 84700 and 84702
Designed In: Inches
Waterproof: Meets requirements of IP67 and NEMA 6P for water tightness

Electrical

Voltage: 56.5V DC
150V RMS AC (ringing voltage only)
Current: 1.5A at 25° C (77° F)
Contact Resistance: 20 milliohms max.
Insulation Resistance: 500 Megohms min.
Transmission Performance: Category 5e
RJ-45 Connection Interface: TIA/EIA-568-B
Shielding Effectiveness: 20 dB min.

Mechanical

Durability: 500 mating cycles min.

Physical

Coupling Ring: PBT, black
O-Ring: Nitrile
Gasket Seal: Nitrile, black
Plug Holder: PBT, black
Retainer Wedge: PBT, black
Wire Gauge: 24 AWG (stranded or solid conductors)
Operating Temperature: -40 to +85° C
Cable Seal Assembly: Polyamide, TPE Gland, black

Description	Lead-free	Standard Order No.
Field Attachable Plug	Yes	84700-0002

*EtherNet IP is a trademark of the Open DeviceNet Vendor Association.

Industrial Ethernet Brad® Sealed RJ-45 Tethered Dust Cap

84700

Bayonet Style



Features and Benefits

- One sealing surface means less likelihood of failure
- Attachable tether so cap never gets lost
- Maintains IP67 and NEMA 6P ratings for functional integrity when connector is not mated
- IP67 and NEMA 6P ratings ensure cable assemblies are water and dust tight for functional integrity

Reference Information

Packaging: Bag
Use With: 84700, 84702, 84729, 84730
Designed In: Inches

Physical

Dust Cap: PBT, black
Tether: PE or PP, black
Gasket Seal: Nitrile, black
Screw: Brass, #8-32
Plating: Screw—Nickel
Operating Temperature: -40 to +85° C

Description	Lead-free	Standard Order No.
Dust Cover	Yes	84700-0003

Industrial Ethernet Brad® Micro-Change® (M12) Single-Ended Cordsets

130048
Male
Threaded



Features and Benefits

- Familiar, proven M12 form factor provides robust connection
- Category 5e compliant
- IP67 rated, perfect for harsh industrial environments
- D-Coded to ensure proper alignment/mating

Reference Information

UL File No.: E200650

Cables

03—Unshielded PVC

Conductors: 24 AWG stranded tinned Copper wire
Pair: Two pair UTP patch cable
Outside Diameter: 0.250" (5.6mm) nominal
Jacket Material: Teal PVC
Cable Properties: Sun and oil resistant
Inner Material Insulation: HDPE
Certification: UL Type CMR, CEC C(UL) Type CMR
TIA/EIA Rating: Category 5e
Operating Temperature: -40 to 75° C

05—Shielded TPE

Conductors: 22 AWG stranded tinned Copper wire
Pair: Two pair UTP patch cable
Outside Diameter: 0.236" (5.99mm) nominal
Jacket Material: Teal TPE
Cable Properties: Sun and oil resistant
Inner Material Insulation: HDPE
Shield Type: Foil shield, 100% coverage, 25% minimum overlap
Flex Rating: Trailing cable, 5 million bending cycles
Certification: UL Type CMR, CEC C(UL) Type CMR
TIA/EIA Rating: Category 5e
Operating Temperature: -20 to 75° C

10—Shielded PUR

Conductors: 22 AWG stranded tinned wire
Pair: Two pair UTP patch cable
Outside Diameter: 0.255" (6.50mm) nominal
Jacket Material: Green PUR
Cable Properties: Sun resistant
Inner Material Insulation: FRNC
Shield Type: Foil Shield—100% coverage
Braid Shield—85% coverage
Flex Rating: Trailing cable, 5 million bending cycles
Certification: UL Listed CMX
TIA/EIA Rating: Category 5e
Operating Temperature: -40 to 70° C

11—Shielded High Flex PUR, PROFINET Type C

Conductors: 22 AWG stranded tinned wire
Pair: 2 Pair STP patch cable
Outside Diameter (Nominal): 6.7mm (0.264")
Jacket Material: PUR, green
Cable Properties: Sun resistant
Inner Material Insulation: Polyolefin
Shield Type: Foil shield, braid shield, tinned Copper with minimum 85% coverage
Flex Rating: Trailing cable, 5 million bending cycles
Certification: UL and CSA
Operating Temperature: -40 to 80° C

15—Shielded PVC

Conductors: 26 AWG stranded tinned Copper wire
Pair: Two pair UTP patch cable
Outside Diameter: 0.236" (5.99mm) nominal
Jacket Material: Teal PVC
Cable Properties: Sun and oil resistant
Inner Material Insulation: Foamed polypropylene
Shield Type: Foil shield, 100% coverage, 25% min. overlap
Certification: UL Type CMR, CEC C(UL) type CMR
TIA/EIA Rating: Category 5e
Operating Temperature: -20 to 75° C

Face View	Max. Current per Contact	Max. Voltage	Cable Type	Cable Jacket	Wire Size AWG	Length	Male Straight-to-Male Straight		Male Right Angle-to-Male Right Angle	
							Engineering No.	Standard Order No.	Engineering No.	Standard Order No.
<p>4 Pole</p> <p>1 - Orange (TD+) 2 - Blue (RD+) 3 - Orange/White (TD-) 4 - Blue/White (TD-)</p>	1.5A	30V	Unshielded	PVC	24	1.0m (3.37')	E10A00603M010	130048-0038	E10A00703M010	130048-0062
			Shielded	PVC	22		E10A00610M010	130048-0046	E10A00710M010	130048-0070
			Shielded	PUR	24	E10A00615M010	130048-0054	E10A00715M010	130048-0078	
			Shielded		22	E10A00611M050	130048-0281	E10A00711M050	130048-0286	
			Shielded High Flex	TPE	26	1.0m (3.37')	E10A00605M010	120108-0186		
			Shielded High Flex						E10A00705M010	120108-0187

Note: Sales drawings for all standard order numbers are available on molex.com

Configuration Code*
Build-a-Part Number

	Length	Code
Meters	1	M010
	2	M020
	5	M050
	10	M100

E10A00610M010

→ Cable Options

*Once an engineering number is created using the configuration code, consult Molex tech support for information regarding any part numbers.

Industrial Ethernet Brad® Micro-Change® (M12) Double-Ended Cordsets

120049/120108/130048

Male-to-Male
Straight, Right Angle
Threaded



Features and Benefits

- Familiar, proven M12 form factor provides robust connection
- Category 5e compliant
- D-Coded to ensure proper alignment/mating
- IP67 rated for harsh environments

Reference Information

UL File No.: E200650

Physical

Connector Body: PUR

O-Ring: Viton®

Coupling Nut: Nickel-plated Brass

Contacts: Copper alloy with Gold over Nickel plating

Environmental

Protection: IP67

NEMA Rating: NEMA 6

Operating Temperature: -20 to +75° C

Cables

03—Unshielded PVC

Conductors: 24 AWG stranded tinned Copper wire

Pair: Two pair UTP patch cable

Outside Diameter: 0.250" (5.6mm) nominal

Jacket Material: Teal PVC

Cable Properties: Sun and oil resistant

Inner Material Insulation: HDPE

Certification: UL Type CMR, CEC C(UL) Type CMR

TIA/EIA Rating: Category 5e

Operating Temperature: -40 to +75° C

04—Unshielded TPE

Conductors: 24 AWG stranded tinned Copper wire

Pair: Two pair UTP patch cable

Outside Diameter: 0.210" (5.3mm) nominal

Jacket Material: Teal TPE

Cable Properties: Sun, oil and weld slag resistant

Inner Material Insulation: HDPE

Flex Rating: rolling band and torsional flex, 10 million cycles

Certification: UL Type CMX, CEC C(UL) Type CMR

TIA/EIA Rating: Category 5e

Operating Temperature: -20 to +75° C

10—Shielded PUR

Conductors: 22 AWG stranded tinned Copper wire

Pair: Two pair UTP patch cable

Outside Diameter: 0.255" (6.5mm) nominal

Jacket Material: Green PUR

Cable Properties: Sun and oil resistant

Inner Material Insulation: FRNC

Shield Type: Foil Shield—100% Coverage

Braid Shield—85% Coverage

Flex Rating: Trailing cable, 5 million bending cycles

Certification: UL Listed CMX

TIA/EIA Rating: Category 5e

Operating Temperature: -40 to +70° C

05—Shielded TPE

Conductors: 26 AWG stranded tinned Copper wire

Pair: Two pair UTP patch cable

Outside Diameter: 0.236" (5.99mm) nominal

Jacket Material: Teal TPE

Cable Properties: Sun and oil resistant

Inner Material Insulation: HDPE

Shield Type: Foil shield, 100% coverage,

25% minimum overlap

Certification: UL Type CMR, CEC C(UL) Type CMR

TIA/EIA Rating: Category 5e

Operating Temperature: -20 to +75° C

11—Shielded High Flex PUR, PROFINET Type C

Conductors: 22 AWG stranded tinned wire

Pair: 2 Pair STP patch cable

Outside Diameter (Nominal): 6.7mm (0.264")

Jacket Material: PUR, green

Cable Properties: Sun resistant

Inner Material Insulation: Polyolefin

Shield Type: Foil shield, braid shield, tinned Copper with minimum 85% coverage

Flex Rating: Trailing cable, 5 million bending cycles

Certification: UL and CSA

Operating Temperature: -40 to 80° C

15—Shielded PVC

Conductors: 26 AWG stranded tinned Copper wire

Pair: Two pair UTP patch cable

Outside Diameter: 0.236" (5.99mm) nominal

Jacket Material: Teal PVC

Cable Properties: Sun and oil resistant

Inner Material Insulation: Foamed polypropylene

Shield Type: Foil shield, 100% coverage,

25% minimum overlap

Certification: UL Type CMR, CEC C(UL) Type CMR

TIA/EIA Rating: Category 5e

Operating Temperature: -20 to +75° C

Face View	Max. Current Per Contact	Max. Voltage	Cable Type	Cable Jacket	Wire Size AWG	Length	Male Straight-to-Male Straight		Male Straight-to-Male Right Angle		Male Right Angle-to-Male Right Angle	
							Engineering No.	Standard Order No.	Engineering No.	Standard Order No.	Engineering No.	Standard Order No.
<p>1 - Orange 4 - Blue-White 2 - Blue 5 - D-Coded 3 - Orange-White</p>	1.5A	30V	Unshielded	PVC	24	1.0m (3.37')	E11A06003M010	130048-0088	E11A06203M010	130048-0137	E11A06303M010	130048-0161
			Unshielded High Flex	TPE	24		E11A06004M010	130048-0095			E11A06304M010	120108-0167
			Shielded	PUR	22		E11A06010M010	130048-0114	E11A06210M010	130048-0145	E11A06310M010	130048-0170
			Shielded High Flex	PUR	22		E11A06011M010	120108-0236				
			Shielded High Flex	PUR	22	2.0m (6.56')			E11A06211M020	120108-0201	E11A06311M020	120108-0200
			Shielded	PVC	26		E11A06015M010	130048-0122	E11A06215M010	130048-0153	E11A06315M010	130048-0179
			Shielded	TPE	26	1.0m (3.37')	E11A06005M010	120108-0188	E11A06205M010	120108-0189	E11A06305M010	120108-0174

Note: Sales drawings for all standard order numbers are available on molex.com.
Viton® is a registered trademark of E.I. DuPont De Nemours and Company.

Configuration Code*
Build-a-Part Number

Meters	Length	Code
	1	M010
	2	M020
	5	M050
	10	M100

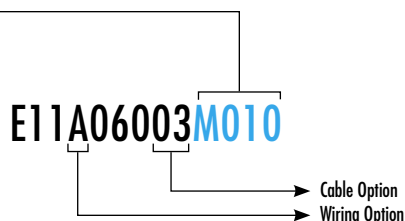

Industrial Ethernet Brad® Micro-Change® (M12) Double-Ended Cordsets

130048
Female-to-Male
Straight
Threaded



Features and Benefits

- Familiar, proven M12 form factor provides robust connection
- Category 5e compliant
- D-Coded to ensure proper alignment/mating
- IP67 rated for harsh environments

Reference Information

UL File No.: E200650

Physical

Connector Body: PUR
O-Ring: Viton®
Coupling Nut: Nickel-plated Brass
Contacts: Copper alloy with Gold over Nickel plating

Environmental

Protection: IP67
NEMA Rating: NEMA 6
Operating Temperature: -20 to 75° C

Cables

03—Unshielded PVC

Conductors: 24 AWG stranded tinned Copper wire
Pair: Two pair UTP patch cable
Outside Diameter: 0.250" (5.6mm) nominal
Jacket Material: Teal PVC
Cable Properties: Sun and oil resistant
Inner Material Insulation: HDPE
Certification: UL Type CMR, CEC C(UL) Type CMR
TIA/EIA Rating: Category 5e
Operating Temperature: -40 to +75° C

15—Shielded PVC

Conductors: 26 AWG stranded tinned Copper wire
Pair: Two pair UTP patch cable
Outside Diameter: 0.236" (5.99mm) nominal
Jacket Material: Teal PVC
Cable Properties: Sun and oil resistant
Inner Material Insulation: Foamed Polypropylene
Shield Type: Foil Shield, 100% coverage, 25% min. overlap
Certification: UL Type CMR, CEC C(UL) Type CMR
TIA/EIA Rating: Category 5e
Operating Temperature: -20 to +75° C

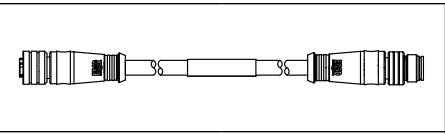

Face View	Max. Current Per Contact	Max. Voltage	Cable Type	Cable Jacket	Wire Size AWG	Length	Female Straight-to-Male Straight	
							Engineering No.	Standard Order No.
<p>4 Pole</p> <p>1 - Orange 4 - Blue-White 2 - Blue 5 - D-Coded 3 - Orange-White</p>	1.5A	30V	Unshielded	PVC	24	.02m	E11B03003M002	130048-0193
			Shielded	PVC	26		E11B03015M002	130048-0195

Note: Sales drawings for all standard order numbers are available on molex.com.
Viton® is a registered trademark of E.I. DuPont De Nemours and Company.

Configuration Code*
Build-a-Part Number

	Length	Code
Meters	1	M010
	2	M020
	5	M050
	10	M100

E11B03003M002

→ Cable Option
→ Wiring Option

Industrial Ethernet Brad® Micro-Change®-to- RJ-45 Standard Plug Double-Ended Cordsets

130048
Female-to-Male
Straight
Threaded to RJ-45



Features and Benefits

- Familiar, proven M12 form factor provides robust connection
- Category 5e compliant
- D-Coded to ensure proper alignment/mating
- IP67 rated for harsh environments

Connectors

M12

Reference Information

UL File No.: E200650

Physical

Connector Body: PUR

O-Ring: Viton®

Coupling Nut: Nickel-plated Brass

Contacts: Copper alloy with Gold over Nickel plating

Operating Temperature: -25 to +75° C

Environmental

Protection: IP67

NEMA Rating: NEMA 6

RJ-45

Reference Information

UL File No.: E200650

Physical

RJ-45 Plug: Polycarbonate, clear

Boot: PVC

Operating Temperature: -20 to +75° C

Environmental

Protection: IP20

Cables

03—Unshielded PVC

Conductors: 24 AWG stranded tinned Copper wire

Pair: Two pair UTP Patch cable

Outside Diameter: 0.250" (5.6 mm) nominal

Jacket Material: Teal PVC

Cable Properties: Sun and oil resistant

Inner Material Insulation: HDPE

Certification: UL Type CMR, CEC C(UL) Type CMR

TIA/EIA Rating: Category 5e

Operating Temperature: -40 to +75° C

11—Shielded High Flex PUR, PROFINET Type C

Conductors: 22 AWG stranded tinned wire

Pair: 2 Pair STP patch cable

Outside Diameter (Nominal): 6.7mm (0.264")

Jacket Material: PUR, green

Cable Properties: Sun resistant

Inner Material Insulation: Polyolefin

Shield Type: Foil shield, braid shield, tinned Copper with minimum 85% coverage

Flex Rating: Trailing cable, 5 million bending cycles

Certification: UL and CSA

Operating Temperature: -40 to 80° C

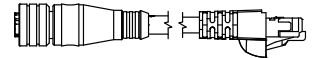

Face View	Max. Current Per Contact	Max. Voltage	Cable Type	Cable Jacket	Wire Size AWG	Length	Female Straight-to-Male Straight	
							Engineering No.	Standard Order No.
<p>4 Pole</p> <p>1 - Orange 4 - Blue-White 2 - Blue 5 - D-Coded 3 - Orange-White</p>	1.5A	30V	Unshielded	PVC	24	1.0m (3.37')	E16A03003M010	130048-0197
			Shielded High Flex	PUR	22		E16A03011M010	120108-0264

Note: Sales drawings for all standard order numbers are available on molex.com.
Viton® is a registered trademark of E.I. DuPont De Nemours and Company.

Configuration Code*
Build-a-Part Number

Meters	Length	Code
		1
	2	M020
	5	M050
	10	M100

E16A03003M010

→ Cable Option
→ Wiring Option

Industrial Ethernet Brad® Micro-Change® (M12) Field Attachable Connectors

130047
Female, Male
Straight
Threaded



Features and Benefits

- Fast field termination without special tooling
- D-Coded to ensure proper alignment/mating

Mechanical

Coupling Nut: Zinc diecast
Shell Material: Zinc diecast
Contacts: Gold-plated Palladium Nickel

Cable

22 to 24 AWG
0.25 to 0.34mm²
Cable Diameter: 5.50 to 7.20mm

Environmental

Protection: IP67

Physical

Operating Temperature: -25 to +85° C

Poles (Female View)	Max. Current per Contact	Max. Voltage	Cable Diameter Range	Male Straight		Female Straight	
				Engineering No.	Standard Order No.	Engineering No.	Standard Order No.
				<p>4 Pole</p> <p>1 - Yellow (TD+) 3 - Orange (TD-) 2 - White (RD+) 4 - Blue (RD-)</p>	4.0A	32V	5.50-7.20mm

Note: Sales drawings for all standard order numbers are available on molex.com

Industrial Ethernet Brad® Ultra-Lock® (M12) Double-Ended Cordsets

120108

Male-to-Male
Straight, Right Angle
Push-to-Lock



Features and Benefits

- Push-to-Lock technology assures fast, reliable connections every time
- Reliable performance in high-vibration environments due to positive locking mechanism
- Ideal for wash-down and temporary submersion applications due to improved sealing design
- Ergonomic push to lock mechanisms reduce fatigue and user errors when a high number of connections need to be made
- Category 5e compliant
- D-Coded to ensure proper alignment/mating
- IP67/68/69K rated for harsh environments

Reference Information

UL File No.: E200650

Physical

Connector Body: PUR
O-Ring: Viton®
Coupling Nut: Nickel-plated Brass
Contacts: Copper alloy with Gold over Nickel plating
Operating Temperature: -20 to +75° C

Environmental

Protection: IP67/IP68/IP69K
NEMA Rating: NEMA 6

Cables

03—Unshielded PVC

Conductors: 24 AWG stranded tinned Copper wire
Pair: Two pair UTP patch cable
Outside Diameter: 0.250" (5.60mm) nominal
Jacket Material: Teal PVC
Cable Properties: Sun and oil resistant
Inner Material Insulation: HDPE
Certification: UL type CMR, CEC C(UL) type CMR
TIA/EIA Rating: Category 5e
Operating Temperature: -40 to +75° C

04—Unshielded TPE

Conductors: 24 AWG stranded tinned Copper wire
Pair: Two pair UTP patch cable
Outside Diameter: 0.210" (5.30mm) nominal
Jacket Material: Teal TPE
Cable Properties: Sun, oil and weld slag resistant
Inner Material Insulation: HDPE
Flex Rating: Rolling band and torsional flex, 10 million cycles
Certification: UL type CMX, CEC C(UL) type CMR
TIA/EIA Rating: Category 5e
Operating Temperature: -20 to +75° C

10—Shielded PUR

Conductors: 22 AWG stranded tinned wire
Pair: Two pair UTP patch cable
Outside Diameter: 0.255" (6.50mm) nominal
Jacket Material: Green PUR
Cable Properties: Sun resistant
Inner Material Insulation: FRNC
Shield Type: Foil Shield—100% coverage
Braid Shield—85% coverage
Flex Rating: Trailing cable, 5 million bending cycles
Certification: UL Listed CMX
TIA/EIA Rating: Category 5e
Operating Temperature: -40 to 70° C

15—Shielded PVC

Conductors: 26 AWG stranded tinned copper wire
Pair: Two pair UTP patch cable
Outside Diameter: 0.236" (5.99mm) nominal
Jacket Material: Teal PVC
Cable Properties: Sun and oil resistant
Inner Material Insulation: Foamed polypropylene
Shield Type: Foil shield, 100% coverage, 25% min. overlap
Certification: UL type CMR, CEC C(UL) type CMR
TIA/EIA Rating: Category 5e
Operating Temperature: -20 to +75° C

Face View (Male)	Max. Current per Contact	Max. Voltage	Cable Type	Cable Jacket	Wire Size AWG	Length	Male Straight-to-Male Straight		Male Straight-to-Male Right Angle		Male Right Angle-to-Male Right Angle	
							Engineering No.	Standard Order No.	Engineering No.	Standard Order No.	Engineering No.	Standard Order No.
<p>1 - White/Orange 3 - Orange 2 - White/Green 4 - Green</p>	1.5A	30V	Unshielded	PVC	24	1.0m	EWWA06003M010	120108-0066	EWWA06203M010	120108-0074	EWWA06303M010	120108-0082
			Unshielded High Flex	TPE	24				EWWA06304M010	120108-5020		
			Shielded	PUR	22		EWWA06010M010	120108-0090	EWWA06210M010	120108-0098	EWWA06310M010	120108-0106
			Shielded	PVC	26		EWWA06015M010	120108-0042	EWWA06215M010	120108-0050	EWWA06315M010	120108-0058

Note: Sales drawings for all standard order numbers are available on molex.com.
Viton® is a registered trademark of E.I. DuPont De Nemours and Company.

Configuration Code*
Build-a-Part Number

Length	Code
1	M010
2	M020
5	M050
10	M100

EWWA06003M010

Cable Option
Wiring Option

*Once an engineering number is created using the configuration code, consult Molex tech support for information regarding any part numbers.

Industrial Ethernet Brad® Ultra-Lock® (M12) Double-Ended Cordset

130048

**Female-to-Male
Straight
Push-to-Lock
Crossover-Wired**



Features and Benefits

- Brad M12 Micro-Change® Threaded to Push-to-Lock Ultra-Lock® technology assures fast, reliable connections every time
- Reliable performance in high-vibration environments due to positive locking mechanism
- Ergonomic push to lock mechanisms reduce fatigue and user errors when a high number of connections need to be made
- Category 5e compliant
- D-Coded to ensure proper alignment/mating
- IP67 rated for harsh environments

Reference Information

UL File No.: E200650

Physical

Connector Body: PUR
O-Ring: Viton®
Coupling Nut: Nickel-plated Brass
Contacts: Copper alloy with Gold over Nickel plating
Operating Temperature: -20 to +75° C

Environmental

Protection: IP67
NEMA Rating: NEMA 6

Cables

03—Unshielded PVC

Conductors: 24 AWG stranded tinned Copper wire
Pair: Two pair UTP patch cable
Outside Diameter: 0.250" (5.60mm) nominal
Jacket Material: Teal PVC
Cable Properties: Sun and oil resistant
Inner Material Insulation: HDPE
Certification: UL type CMR, CEC C(UL) type CMR
TIA/EIA Rating: Category 5e
Operating Temperature: -40 to +75° C

10—Shielded PUR

Conductors: 22 AWG stranded tinned wire
Pair: Two pair UTP patch cable
Outside Diameter: 0.255" (6.50mm) nominal
Jacket Material: Green PUR
Cable Properties: Sun resistant
Inner Material Insulation: FRNC
Shield Type: Foil Shield—100% coverage
Braid Shield—85% coverage
Flex Rating: Trailing cable, 5 million bending cycles
Certification: UL Listed CMX
TIA/EIA Rating: Category 5e
Operating Temperature: -40 to +70° C

15—Shielded PVC

Conductors: 26 AWG stranded tinned Copper wire
Pair: Two pair UTP patch cable
Outside Diameter: 0.236" (5.99 mm) nominal
Jacket Material: Teal PVC
Cable Properties: Sun and oil resistant
Inner Material Insulation: Foamed polypropylene
Shield Type: Foil Shield, 100% coverage, 25% min. overlap
Certification: UL type CMR, CEC C(UL) type CMR
TIA/EIA Rating: Category 5e
Operating Temperature: -20 to +75° C

Face View	Max. Current per Contact	Max. Voltage	Cable Type	Cable Jacket	Wire Size AWG	Length	M12 Micro-Change Female Straight-to-M12 Ultra-Lock Male Straight	
							Engineering No.	Standard Order No.
<p>1 - Orange 4 - Blue-White 2 - Blue 5 - D-Coded 3 - Orange-White</p>	1.5A	30V	Unshielded	PVC	24	0.2m	E1WB03003M002	130048-0207
			Shielded	PUR	22		E1WB03010M002	130048-0208
			Shielded	PVC	26		E1WB03015M002	130048-0209

Note: Sales drawings for all standard order numbers are available on molex.com.
Viton® is a registered trademark of E.I. DuPont De Nemours and Company.

Configuration Code*
Build-a-Part Number

	Length	Code
Meters	.2	M002
	2	M020
	5	M050
	10	M100

E1WB03003M002

→ Cable Option
→ Wiring Option

*Once an engineering number is created using the configuration code, consult Molex tech support for information regarding any part numbers.

Industrial Ethernet Brad® Ultra-Lock® (M12) Receptacles

120109

Female
Front Panel Mount
Back Panel Mount
Internal Thread



Features and Benefits

- Mates with both threaded M12 and Ultra-Lock® M12 cordsets
- Category 5e compliant
- IP67 rated, perfect for harsh industrial environments
- D-Coded to ensure proper alignment/mating

Reference Information

UL File No.: E200650

Physical

Shell: Nickel-plated Brass
Insert: PUR
Conductors: Brass Gold-plated/Bronze selective Gold-plated
O-Ring: Viton®
Operating Temperature: -20 to +80° C

Environmental

Protection: IP67
NEMA Rating: NEMA 6

Configuration			
	Front-Panel Mount / PG9 with 50.00mm Wire Leads	Front-Panel Mount / M16 with 50.00mm Wire Leads	Back-Panel Mount / M16 with 50.00mm Wire Leads
	Wire Type PVC Leads, UL 1061		
	Wire Size (AWG) 22 AWG		
Length .05m			

Pole (Female View)	Max. Current per Contact	Max. Voltage	Engineering No.	Standard Order No.	Engineering No.	Standard Order No.	Engineering No.	Standard Order No.
<p>1 - Orange 4 - Blue-White 2 - Blue 5 - D-Coded 3 - Orange-White</p>	1.5A	125V	ERWAAJ3000C050	120109-0004	ERWAAU3000C050	120109-5001	ERWAAU7000C050	120109-5002

Note: Sales drawings for all standard order numbers are available on molex.com.
Viton® is a registered trademark of E.I. DuPont De Nemours and Company.

Configuration Code*
Build-a-Part Number

	Length	Code
Centimeters	5	C050
	0.3	M003
Meters	1	M010
	2	M020

ERWAAJ3000C050

*Once an engineering number is created using the configuration code, consult Molex tech support for information regarding any part numbers.

Industrial Ethernet Brad® Ultra-Lock® (M12) Receptacles

120109

Female
Back Panel Mount
Front Panel Mount



Features and Benefits

- Mates with both threaded M12 and Brad Ultra-Lock M12 cordsets
- Category 5e compliant
- IP67 rated, perfect for harsh industrial environments
- D-Coded to ensure proper alignment/mating

Mechanical

Shell: Nickel-plated Brass
Insert: PUR
Conductors: Brass Gold-plated/Bronze selective Gold-plated
O-Ring: Viton®

Electrical

TIA/EIA Rating: Category 5e

Environmental

Protection: IP67
NEMA Rating: NEMA 6

	Configuration			Front Panel Mount, PG9 Thread		Front Panel Mount, M16 Thread		Back-Panel Mount, M16 Thread	
				PCB Mount		PCB Mount		PCB Mount	
	Poles	Max. Current per Contact	Max. Voltage	Engineering No.	Standard Order No.	Engineering No.	Standard Order No.	Engineering No.	Standard Order No.
<p>4 Pole</p> <p>1 - Orange 4 - Blue-White 2 - Blue 5 - D-Coded 3 - Orange-White</p>	1.5A	125V	ERWD2J30	120109-5003	ERWD2U30	120109-5004	ERWD2U70	120109-5005	

Note: Viton® is a registered trademark of E.I. DuPont De Nemours and Company.

Industrial Ethernet Brad® Ultra-Lock® (M12) Receptacles

120109

Female
Straight
Back Panel Mount



Features and Benefits

- Mates with both threaded M12 and Ultra-Lock M12 cordsets
- Category 5e compliant
- IP67 rated, perfect for harsh industrial environments
- D-Coded to ensure proper alignment/mating

Mechanical

Shell: Nickel-plated Brass
Insert: PUR
Conductors: Brass Gold-plated/Bronze selective Gold-plated

Electrical

TIA/EIA Rating: Category 5e

Environmental

Protection: IP67
NEMA Rating: NEMA 6

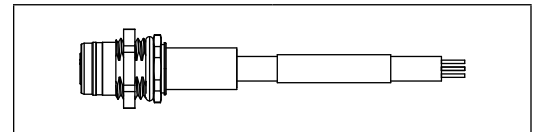

Straight, Back Panel Mount

Poles	Max. Current per Contact	Max. Voltage	Engineering No.	Standard Order No.
<p>4 Pole</p> <p>1 - Yellow (TD+) 3 - Orange (TD-) 2 - White (RD+) 4 - Blue (RD-)</p>	1.5A	125V	ERWAAJ4002M002	130054-0012
			ERWAAJ4002M020	130054-0013

Note: Sales drawings for all standard order numbers are available on molex.com

Configuration Code*
Build-a-Part Number

	Length	Code
Meters	2	M020
	5	M050
	10	M100

ERWAAJ4002M020

*Once an engineering number is created using the configuration code, consult Molex tech support for information regarding any part numbers.

Industrial Ethernet Brad® Ultra-Lock® (M12) Double-Ended Receptacles

120109

M12 Panel Mount Female Receptacle-to-RJ-45 Male Plug



Features and Benefits

- Mates with both threaded M12 and Ultra-Lock M12 cordsets
- Category 5e compliant
- IP67 rated, perfect for harsh industrial environments
- D-Coded to ensure proper alignment/mating

Reference Information

UL File No.: E200650

Mechanical

Shell: Nickel-plated Brass
Insert: Nylon
Conductors: Brass Gold-plated/Bronze selective Gold-plated
O-Ring: Viton®
Cable: PVC Jacket

Electrical

TIA/EIA Rating: Category 5E

Environmental

Protection: IP67

Cables

03—Unshielded PVC

Conductors: 24 AWG stranded tinned Copper wire
Pair: Two pair UTP Patch cable
Outside Diameter: 0.250" (5.6 mm) nominal
Jacket Material: Teal PVC
Cable Properties: Sun and oil resistant
Inner Material Insulation: HDPE
Certification: UL Type CMR, CEC C(UL) Type CMR
TIA/EIA Rating: Category 5e
Operating Temperature: -40 to +75° C

11—Shielded High Flex PUR, PROFINET Type C

Conductors: 22 AWG stranded tinned wire
Pair: 2 Pair STP patch cable
Outside Diameter (Nominal): 6.7mm (0.264")
Jacket Material: PUR, green
Cable Properties: Sun resistant
Inner Material Insulation: Polyolefin
Shield Type: Foil shield, braid shield, tinned Copper with minimum 85% coverage
Flex Rating: Trailing cable, 5 million bending cycles
Certification: UL and CSA
Operating Temperature: -40 to 80° C

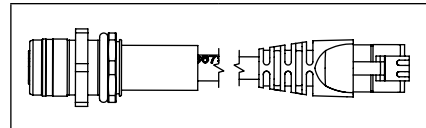

Pole (Female View)	Max. Current per Contact	Max. Voltage	Cable Type	Cable Jacket	Wire Size	Length	Straight, Back Panel Mount, M16 Thread	
							Engineering No.	Standard Order No.
<p>1 - (TD+) 3 - (TD-) 2 - (RD+) 4 - (RD-)</p>	1.5A	30V	Unshielded	PVC	24	0.6m (1.97')	ERWPAU7003M006	120109-0005
			Shielded High Flex	PUR	22	1.0m (3.37')	ERWPAU7011M010	120108-0252

Note: Sales drawings for all standard order numbers are available on molex.com.
Viton® is a registered trademark of E.I. DuPont De Nemours and Company.

Configuration Code*
Build-a-Part Number

	Length	Code
Meters	2	M020
	5	M050
	10	M100

ERWPAU7003M006

*Once an engineering number is created using the configuration code, consult Molex tech support for information regarding any part numbers.

Industrial Ethernet Brad® Micro-Change® (M12) Bulkhead Pass-Through Adapters

130054

**Female Straight,
Female Straight-to-Right Angle
Threaded
Back Panel Mount**

Features and Benefits

- Mates with both threaded M12 and (M12) cordsets
- Category 5e compliant
- IP67 rated, perfect for harsh industrial environments
- D-Coded to ensure proper alignment/mating

Mechanical

Shell: Nickel-plated Brass
Insert: PUR
Conductors: Brass Gold-plated/Bronze selective Gold-plated
O-Ring: Viton®

Electrical

Voltage Rating: 215V
Current: 4.0A
TIA/EIA Rating: Category 5e

Environmental

Protection: IP67

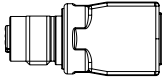
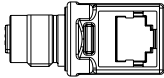
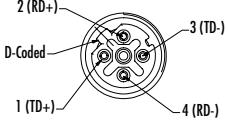

Poles				
	M12-to-RJ-45 Adapter with M16 Mounting Thread			
	Female Straight		Female-Straight-to-Right Angle	
	Engineering No.	Standard Order No.	Engineering No.	Standard Order No.
4 Pole  1 - Yellow (TD+) 3 - Orange (TD-) 2 - White (RD+) 4 - Blue (RD-)	ER1PADAPTER	130054-0009	ER1PADAPTER90	130054-0010

Note: Sales drawings for all standard order numbers are available on molex.com.
Viton® is a registered trademark of E.I. DuPont De Nemours and Company.

Brad® Micro-Change® M12 CHT Circular Hybrid Technology Connector

120244/120355



Features and Benefits

- Shielded data lines for Cat 5e performance
- Fully shielded Cat 5e, 4-pin array with a wrap-around metal tube shielding
- Cat 5e data lines and power lines, carrying 6A (4+4) or 10A (4+2), in one connector
- IP67-sealed interface
- Cordsets feature M12 overmolded male-to-male CHT cable connectors
- Nickel-plated Brass cordset coupling nuts and receptacle shells

Physical

Connector Body: PUR
 Contact Carries: PUR for cable/Polyamide for receptacle
 O-Ring: NBR
 Coupling Nut: Nickel-plated Brass
 Contacts: Brass, Gold over Nickel
 Cables: Cable Jacket—PUR
 Data Lines—26 AWG
 Power Lines 4+4—0.75mm²
 Power Lines 4+2—1.5mm²

Environmental

Protection: IP67
 Operating Temperature: -25° C to +75° C

Cordset CHT 4+4

Front View	Max. Current per Contact	Max. Voltage	Wire Size	Length	Engineering No.	Standard Order No.
	1.5A signal, 6A power	30V	Data Lines: 26 AWG Power Lines: 0.75mm ²	0.5m	1202440201	120244-0201
				1m	1202440202	120244-0202
				1.5m	1202440203	120244-0203
				2m	1202440204	120244-0204
				5m	1202440205	120244-0205
				10m	1202440207	120244-0207

Cordset CHT 4+2

Front View	Max. Current per Contact	Max. Voltage	Wire Size	Length	Engineering No.	Standard Order No.
	1.5A signal, 10A power	30V	Data Lines: 26 AWG Power Lines: 1.5mm ²	0.5m	1203550014	120355-0014
				1m	1203550015	120355-0015
				1.5m	1203550016	120355-0016
				2m	1203550017	120355-0017
				5m	1203550018	120355-0018
				10m	1203550020	120355-0020

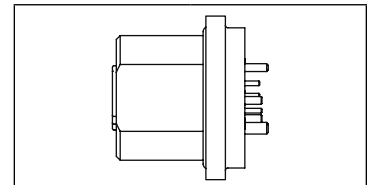

Receptacle

Pinning	Face View	Current (max. per contact)	Voltage (max.)	Connection	Configuration	Engineering No.	Standard Order No.
CHT 4+4		1.5A signal, 6A power	30V	PCB Pins	M16x1.5, back mount	1202440002	120244-0002
CHT 4+2		1.5A signal, 10A power	30V	PCB Pins	M16x1.5, back mount	1203550056	120355-0056

Brad® Micro-Change® (M12) X-Coded Cat6_A Receptacles 120341 Female



Features and Benefits

- Robust, compact M12 CAT6_A X-Coded connector design
- Complete 360° shielded design
- External and internal O-ring seals
- Receptacle PCB stand-offs
- Nickel-plated Brass housings and coupling nuts
- System mates using a standard M12 threaded coupling nut
- Receptacles can be mounted using through-hole reflow (THR) technology

Reference Information

Packaging:
Receptacles—Blister packs (25 pieces per pack)
UL File No.: E200650 pending
RoHS: Yes
Halogen Free: Yes

Electrical

Voltage (max.): 48V
Current (max.): 0.5A
Contact Resistance: <5m Ohm
Insulation Resistance: >100M Ohm
Transmission Characteristics (Category): 6_A to TIA-568 and ISO/IEC 11801

Physical

Housing: Nickel-plated Brass
Coupling Nut: Nickel-plated Brass
Contact: Gold over Nickel

Environmental

Protection: IP67
Operating Temperature: -25 to +85° C

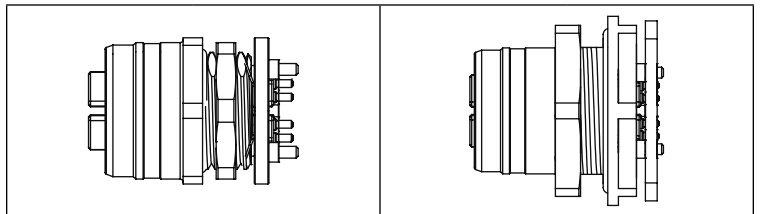

Face View	Max. Current per Contact	Max. Voltage	Front Panel Mount		Back Panel Mount	
			Engineering No.	Standard Order No.	Engineering No.	Standard Order No.
<p>1 - White-Orange 2 - Orange 3 - White-Green 4 - Green 5 - White-Brown 6 - Brown 7 - White-Blue 8 - Blue</p>	0.5A	48V	1203410075	120341-0075	1203410150	120341-0150

Brad® Micro-Change® (M12) X-Coded Cat6_A Double-Ended Cable Assemblies

120341
Male



Features and Benefits

- Robust, compact M12 CAT6_A X-Coded connector design
- Complete 360° shielded design: 4 twisted-cable pairs individually shielded and protected with a braided metal shield
- Male connector features X-Coded keying alignment
- Recessed male pins within die-cast metal X-Coded shield
- External and internal O-ring seals
- Factory overmolded and tested cable assemblies in AWG 26 wire gauge
- Nickel-plated Brass coupling nuts
- System mates using a standard M12 threaded coupling nut

Reference Information

Packaging:
Cables—Plastic bags, carton
UL File No.: E200650 pending
RoHS: Yes
Halogen Free: Yes

Electrical

Voltage (max.): 48V
Current (max.): 0.5A
Contact Resistance: <5m Ohm
Insulation Resistance: >100M Ohm
Transmission Characteristics (Category): 6_A to TIA-568 and ISO/IEC 11801

Physical

Coupling Nut: Nickel-plated Brass
Contact: Gold over Nickel
Connector Body: PUR black
Cable: Blue PUR outer jacket, 4 twisted pairs 26 AWG,
Pair Shielding—Aluminum-bonded polyester tape (PIMF)
Cable Shielding—Tinned
Copper Wire Braid: -40 to +70° C

Environmental

Protection: IP67
Operating Temperature: -40 to +70° C

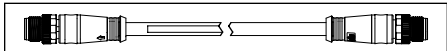

Poles	Max. Current per Contact	Max. Voltage	Cable Type	Cable Jacket	Wire Size AWG	Cable Length	Engineering No.	Standard Order No.
<p>8 Pole</p> <p>1 - White-Orange 2 - Orange 3 - White-Green 4 - Green 5 - White-Brown 6 - Brown 7 - White-Blue 8 - Blue</p>	0.5A	48V	Shielded	PUR	26	0.5m	1203410300	120341-0300
						1.0m	1203410301	120341-0301
						2.0m	1203410302	120341-0302
						3.0m	1203410303	120341-0303
						4.0m	1203410304	120341-0304
						5.0m	1203410305	120341-0305
10.0m	1203410306	120341-0306						

Brad® Other Networks

The Brad product portfolio covers more than 40 industrial protocols including current and legacy networks such as Modbus, CANopen, Serial, AS-interface, and CC-Link. Brad products offer users a complete communication and connectivity solution—from software drivers, interface cards, PLC communication modules, industrial gateways, IP67 digital I/O modules and network media. With over 20 years of experience and technical expertise in industrial communication and control, Molex is a dependable partner. Brad systems are installed around the world in sectors as varied as petrochemical, automotive, food processing and building management. Brad product lines are developed in compliance with the standards and specifications published by international organizations to guarantee a high level of performance, reliability and availability.

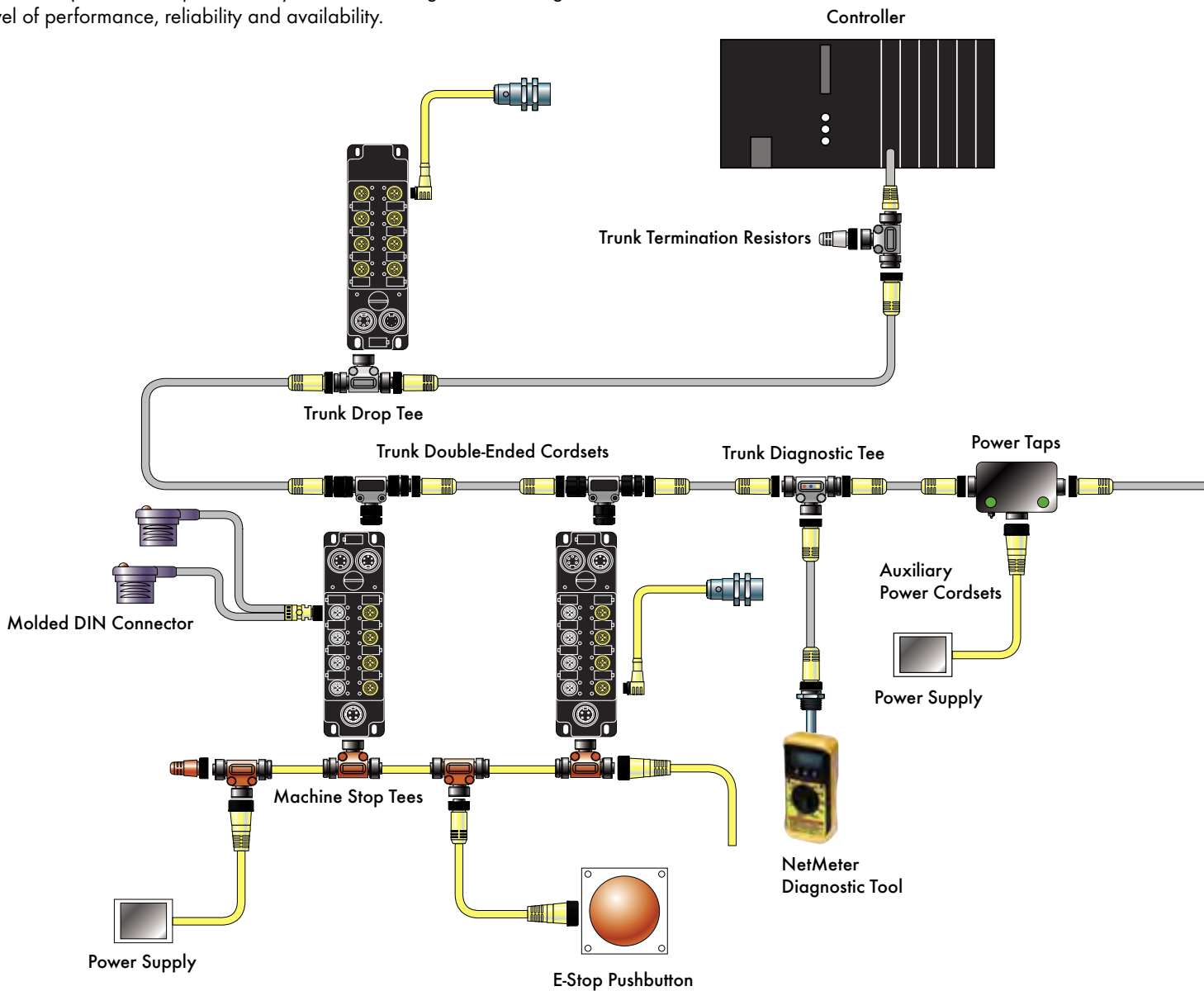



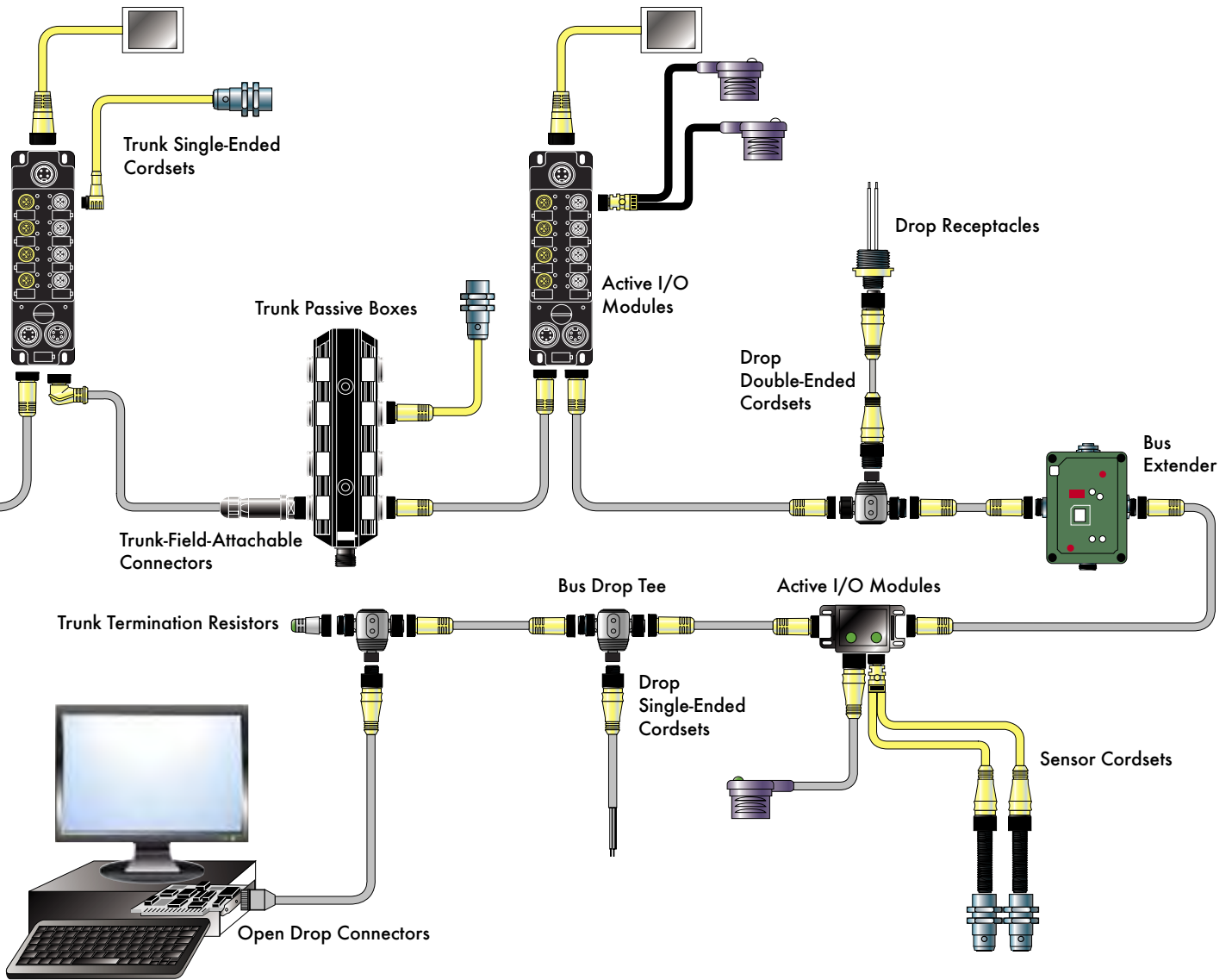







Other Networks



PC-Based Control/HMI/SCADA

Components and Elements of DeviceNet System

- | | | | |
|---|-------------------|---|-----------------|
|  | Controller |  | Thick Media |
|  | I/O Devices |  | Thin Media |
|  | IP67 I/O Modules |  | Power Media |
|  | Media |  | Cordsets |
|  | Network Interface |  | I/O Connections |

Brad® SST™ Communication Module for Rockwell SLC 500

112019
AS-interface Scanner



Features and Benefits

- Connects your Allen-Bradley® SLC 500 to a AS-interface network
- Target markets: Factory automation, Process control, Complex machines, etc.
- Direct IO Mapping, no Ladder Logic to write for configuration and data transfer between module and SLC processor
- Supports 2 independent AS-i networks with up to 124 AS-i slave devices

Description

- High speed deterministic communication
- Fast, easy setup into SLC backplane
- AS-i IO data mapped into the SLC processor's I/O files
- Status information is mapped into the M0 and M1 files
- Multiple SST-ASI-SLC modules can be used in one SLC rack
- Configures scanner with Rockwell RSLogix 500
- Flash memory for storage of AS-i master IO configuration
- Easy diagnostics: Built-in LEDs

Included Hardware/Software

- Acts as 1756 Input/Output module
- Support multiple modules in a chassis
- 2x AS-interface Master channels
- Maximum slave supported: Up to 62 slaves on each channel
- AS-i Cycle Time: 150 μsec* (number of slaves +2)
- AS-I connector: 4-pin combicon connector
- IO Mapping:
 - I and O files: 32 words in, 32 words out
 - M1 and M0 files: 461 words in/out
- 1 Serial port for configuration and diagnostic
- Firmware upgradeable

Compatible Protocols

AS-interface Scanner compliant with specification 3.0

Conformance

- RoHS compliant
- CE
- AS-interface certified
- Rockwell Encompass™

Description	Engineering No.	Standard Order No.
AS-interface Communication module for Rockwell SLC 500	SST-ASI-SLC	112019-0004

Brad® SST™ Communication Module for Rockwell ControlLogix

112078
Serial and Ethernet TCP/IP



Features and Benefits

- Connects your Allen-Bradley ControlLogix to a Modbus Serial network
- Direct IO Mapping, no Ladder Logic to write for configuration and data transfer between module and CLX processor
- Fully integrated into the Rockwell Automation environment
- User-friendly configuration tool with intuitive graphical interface

Description

- RLL support: remote configuration and monitoring via RSLinx
- Add-On-Profile for Rockwell RSLogix5000
- USB port for user configuration and firmware upgrade
- Engineering console simplified user configuration and diagnostic
- Support multiple modules in a chassis
- Support Local and Remote chassis
- Easy diagnostics: Built-in LEDs and 4 characters display

Included Hardware/Software

- 128 MB of onboard memory
- 8 MB of flash memory (user configuration data and firmware)
- CPU Data exchange:
 - 496 Inputs bytes + 496 Output bytes
 - 32,000 Words Registers (CIP messaging)
- Type A, USB 2 and 1.1 compatible
- Communication Ports
 - 4x Serial, 110 bps to 115.2 kbps, RS232/RS485/RS422, RJ45 (DB9 male supplied cable)

Compatible Protocols

- Modbus Master (RTU or ASCII)
- Modbus Slave (RTU or ASCII)

Conformance

- RoHS compliant
- CE
- UL
- cUL
- Class 1 Div 2
- Rockwell Encompass™

Description	Engineering No.	Standard Order No.
Modbus communication module for Rockwell ControlLogix	SST-SR4-CLX-RLL	112078-0001

Brad® SST™ Network Interface Card

112079

CC-Link Slave



Features and Benefits

- Deterministic data exchange with CC-Link controller for real time control applications
- On board co-processor eliminates data bottlenecks, ensuring delivery of time critical information
- Best choice for Supervision/HMI/SCADA applications

Description

- Demo test software and sample source codes are available to enable fast integration of CC-Link into your application.
- Auto-Boot (Configuration stored in Flash)
- Includes Development Libraries
- Supported OS:
 - VxWorks
 - Windows 32-bit
 - Others: Open, documented memory map interface with C source code samples for custom driver development

Included Hardware/Software

- Bus Format
 - PCI Universal bus 3.3V/5V (PCI-X compatible)
- Hardware Plug and Play
- ColdFIRE
- 256 Kb RAM + 256 Kb Flash Memory
- One Digital Input + 1 Digital Output
- One CC-Link port
- Connector: CC-Link compliant 5 pin terminal block with screws
- External Power: Nil
- Isolation: 500 Volts
- Display LEDs: ERR, RUN, SD and RD
- Station Number: 1 to 64
- Occupied Stations: 1 to 4
- Speed: 156K, 625K, 2.5M, 5M and 10M baud

Compatible Protocols

CC-Link Slave according spec. v1.1

Conformance

- RoHS compliant
- CE
- CC-Link conformance tested

Description	Engineering No.	Standard Order No.
PCI Network Interface Card for CC-Link, Bulk of 50	SST-CCS-PCU-B50	112079-7001
PCI Network Interface Card for CC-Link	SST-CCS-PCU	112079-7002

Brad® applicom® Network Interface Card

112023

CANopen for PC-Based Control
and SCADA/HMI



Features and Benefits

- Deterministic data acquisition for real time PC-based control applications
- On board co-processor eliminates data bottlenecks, ensuring delivery of time critical information
- Very easy-to-use; no knowledge of protocol required
- Remote access via serial connection; enables configuration and diagnostic when using real time OS (VxWorks, QNX, etc.)
- Run Master and Slave modes simultaneously

Description

- Auto mapping of IO in card DPRAM
- IO exchange up to 14 Kbytes
- Hardware and software Watchdog
- Auto-Boot (Configuration stored in Flash)
- Engineering Tools:
 - Engineering console with automatic test and diagnostic tools
- Compatible Data Servers:
 - OPC DA v3.0, 2.05 and 1.0a
 - Wonderware® DAServer (XP only)
 - Wonderware IO (SuiteLink/FastDDE) (XP only)
- Includes Development Libraries
- Supported OS:
 - Windows (32-bit and 64-bit): 7, 2008 Server, Windows Vista®, 2003 Server, Windows XP®/XP Embedded
 - Others: Linux, VxWorks, RTX VenturCom

Included Hardware/Software

- PC/104 bus
- 8 Mb SDRAM; 512 Kb Flash Memory
- One Digital Input + 1 Digital Output
- One CANopen port
- Connector: HE13 2x5 pins
- Speed: 1 Kbps up to 1 Mbps
- LEDs for system status and communications status

Conformance

- RoHS compliant
- CE
- OPC certified

Description	Engineering No.	Standard Order No.
PC/104 Network Interface Card for CANopen, HE13 Connector	DRL-CNO-104	112023-0007
PC/104 Network Interface Card for CANopen, Bulk of 25	DRL-CNO-104-B25	112023-5001

Brad® applicom® Network Interface Card

112021

CANopen for PC-Based Control and SCADA/HMI



Features and Benefits

- Deterministic data acquisition for real time Control applications
- On board co-processor eliminates data bottlenecks, ensuring delivery of time critical information
- Very easy-to-use; no knowledge of protocol required
- Remote Access via TCP/IP connection; enables configuration and diagnostic when using real time OS (VxWorks, QNX, etc.)

Description

- High speed Auto mapping of IO in card DPRAM
- Hardware and software Watchdog
- Auto-Boot (Configuration stored in Flash)
- Engineering Tools:
 - Engineering console with automatic test and diagnostic tools
- Compatible Data Servers:
 - OPC DA v3.0, 2.05 and 1.0a
 - Wonderware® DAServer (XP only)
 - Wonderware IO (SuiteLink/FastDDE) (XP only)
- Includes Development Libraries
- Supported OS:
 - Windows (32-bit and 64-bit): 7, 2008 Server, Windows Vista®, 2003 Server, Windows XP®/XP Embedded
 - Others: Linux, VxWorks, RTX VenturCom

Included Hardware/Software

- Bus Format
 - PCI Universal bus 3.3V/5V (PCI-X compatible)
 - PCI Express 1x
- Hardware Plug and Play
- AMD SC520
- 16 Mb SDRAM; 4 Mb Flash Memory
- One Digital Input + 1 Digital Output
- One CANopen port, DB9 male
- Speed: 1 Kbps up to 1 Mbps

Conformance

- RoHS compliant
- CE
- OPC certified
- PCI Express certified

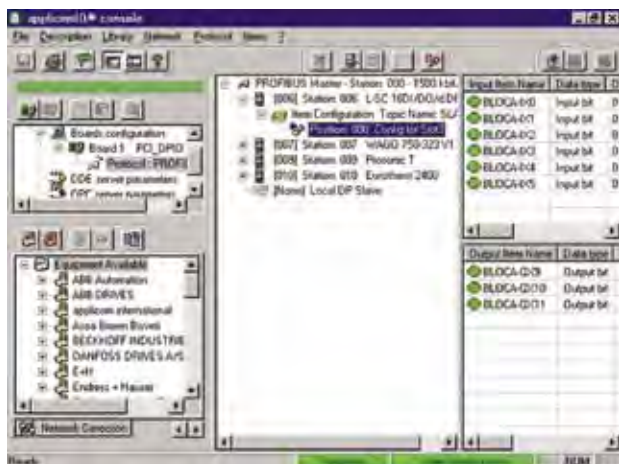

Configuration Console



Device Diagnostics

Description	Engineering No.	Standard Order No.
PCI Network Interface Card for CANopen	DRL-CNO-PCU	112021-0014
PCI Express Network Interface Card for CANopen	DRL-CNO-PCIE	112086-5018

Brad® applicom® Network Interface Card

112020

Serial Protocol for SCADA/HMI



Features and Benefits

- Fast data acquisition between PC-based applications and industrial devices connected to Serial networks
- On board co-processor eliminates data bottlenecks, ensuring delivery of time critical information
- All protocols are included
- Best choice for Supervision/HMI/SCADA applications
- Equipment redundancy via OPC server
- Combo offer: Serial + Ethernet

Description

- Engineering Tools:
 - Engineering console
 - Test and diagnostic tools
- Compatible Data Servers:
 - OPC DA v3.0
 - Wonderware® DAServer (XP only)
 - Wonderware IO (SuiteLink/FastDDE) (XP only)
- Includes Development Libraries
- Supported OS:
 - Windows (32-bit and 64-bit): Seven, 2008 Server, Windows Vista®, 2003 Server, Windows XP®/XP Embedded
 - Others: Linux, VxWorks, RTX VenturCom

Included Hardware/Software

- Bus Format
 - PCI Universal bus 3.3V/5V (PCI-X compatible)
 - PCI Express 1x
- Hardware: Plug and Play
- AMD SC520
- 16 Mb SDRAM
- 4 Mb Flash Memory
- One Ethernet port
 - Fast Ethernet 10/100 Mbps, auto negotiating
 - Base-T (RJ-45), 4 leds (Rx, Tx, Link, 10/100)

Compatible Protocols

- Allen-Bradley® DF1 Master (PLC-5 and SLC Series)
- Elsag Bailey® Data Link Master (5000 and 2000 Series)
- GE Fanuc® SNPX Master (90-xx and 80-xx Series)
- Moeller Group® Sucoma Master (PS32, PS316 Series)
- Modbus Master® (ASCII and RTU)
- Modbus Slave® (ASCII and RTU)
- Omron® Sysmac Way Master
- Saia Burgess® S-Bus Master (PCD Series)
- Schneider Electric® Uni-Telway Master/Slave (TSX 7 Series)
- Siemens® 3964/3964R Free or RK512 Master
- Siemens AS511 Master (Simatic S5 Series)
- Siemens PPI/PPI+ Master (Simatic S7-200 Series)
- Siemens Ti-Dir Master (Simatic TI-505 Series)

Conformance

- RoHS compliant
- CE
- OPC certified
- PCI Express certified
- Rockwell Encompass™
- Schneider Collaborative

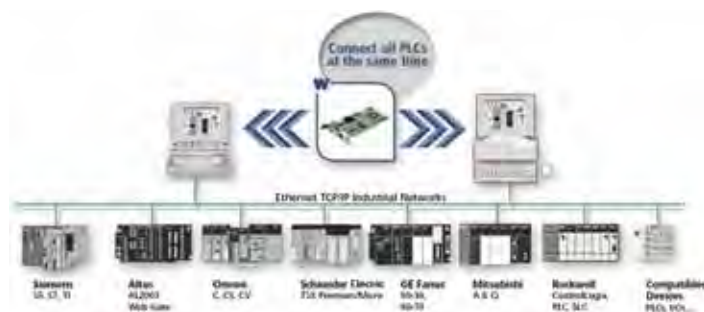

Description	Engineering No.	Standard Order No.
PCU1000 PCI Network Interface Card for Serial	APP-SR1-PCU-C	112020-5017
PCIE1000 PCI Network Interface Card for Serial	APP-SR1-PCIE	112020-5018
PCU2000ETH PCI Network Interface Card for Serial + Ethernet	APP-ESR-PCU-C	112000-0003
PCIE2000ETH PCI Express Network Interface Card for Serial + Ethernet	APP-ESR-PCIE	112000-5027

Brad® Direct-Link® Windows Compatible Protocol Drivers

112027

Serial and Ethernet TCP/IP



Features and Benefits

- Direct-Link® SW1000 provides data acquisition between Windows PC-based applications and industrial devices connected to Ethernet TCP/IP
- Economic solution; well suited for embedded and light architecture (laptop, panel PC, MMI)
- 100% software solution; use PC COM port or integrated Ethernet interface (3COM, NE2000)
- Wide variety of open and vendor specific industrial protocols
- 1000 tags, full tags and Siemens (S5, S7, TI) versions

Description

- Based on Windows TCP/IP socket
- All Ethernet protocols can run simultaneously
- All Ethernet protocols can run Client and Server modes
- Database (32 Kbits, 32 Kwords) for Server mode to exchange data with applications

Included Hardware/Software

- Engineering Tools:
 - Engineering console
 - Test and diagnostic tools
- Compatible Data Servers:
 - OPC DA v3.0, 2.05 and 1.0a
 - Wonderware® DAServer (XP only)
 - Wonderware IO (SuiteLink/FastDDE) (XP only)
- Includes Development Libraries
- Windows compatibility (32-bit and 64-bit): 7, 2008 Server, Windows Vista®, 2003 Server, Windows XP®
- Software or Dongle (Parallel or USB) Protection

Compatible Protocols

- Serial
 - Modbus Master (ASCII and RTU)
 - Modbus Slave (ASCII and RTU)
 - GE Fanuc® SNPX Master (90-xx and 80-xx Series)
 - Schneider Electric® Uni-Telway Slave (TSX 7 Series)
 - Siemens® AS511 Master (Simatic S5 Series)
 - Siemens PPI/PPI+ Master (Simatic S7-200 Series)
 - Siemens TI-Dir Master (Simatic TI-505 Series)
- Ethernet TCP/IP
 - Altus® Alnet II (AL200x, webgate); Client/Server
 - Alstom® SRTP (C80-35, C80-75); Client/Server
 - Allen-Bradley® Logix5000 (ControlLogix and FlexLogix); Client/Server
 - GE Fanuc SRTIP (C90-30, C90-70); Client/Server
 - Mitsubishi® Melsec (A and Q); Client/Server
 - Omron® FINS (C, CV, CS); Client/Server
 - Schneider Electric Modbus TCP and UDP; Client/Server
 - Schneider Electric UNI-TE (Premium and Micro); Client/Server
 - Siemens Industrial Ethernet (S5, S7, TI); Client/Server

Description	Engineering No.	Standard Order No.
SW1000 software drivers, 1000 tags, Software key protection	DRL-ALL-SWL-S	112027-0005
SW1000 software drivers, Full tags, Software key protection	DRL-ALL-SWF-S	112027-0002
SW1000 for Siemens (S5, S7, TI), Full tags, Software key protection	DRL-SIE-SWF-S	112027-5014
SW1000 software drivers, 1000 tags, USB dongle protection	DRL-ALL-SWL-U	112027-0006
SW1000 software drivers, Full tags, USB dongle protection	DRL-ALL-SWF-U	112027-0003
SW1000 for Siemens (S5, S7, TI), Full tags, Software key protection, USB dongle protection	DRL-SIE-SWF-U	112027-5015
SW1000 upgrade from 1000 tags to Full tags	DRL-UPG-SWF	112027-0010

Brad® HarshIO 600

112098

CANopen Digital IP67 I/O module—Compact format



Features and Benefits

- Reliable solution for connecting industrial controllers to IO devices in harsh duty environments
- Visible LEDs provide maintenance personnel with the ability to easily determine IO, module and network status

Description

- Rated IP67 for harsh environments
- Designed for direct machine mount applications
- Eight digital input/output module
- Supports PNP and NPN input devices

Compatible Protocols

CANopen Slave (DS401 Profile)

Conformance

- IP67 according to IEC 60529
- Vibration: IEC 60068-2-6 conformance
- Mechanical Shock: 10G, 11ms, 3 axis
- CE
- UL
- cUL
- RoHS compliant
- CANopen certified

Included Hardware/Software

- IO Configurations:
 - 8 inputs
 - 6 inputs + 2 outputs
 - 4 inputs + 4 outputs
 - 8 outputs
 - 8 universal (inputs or outputs)
- IO Connectors: 8x ports, M8 female 3-pole threaded
- CANopen Connectors:
 - 1x M12 male, 5-pole A-Coding
 - 1x Brad Ultra-Lock® (M12) female, 5-pole, A-Coding
- Power Requirements:
 - Module input power—24V DC
 - Module output power—24V DC, 4.0A max.
- Input Type:
 - Compatible with dry contact and PNP or NPN
 - Electronic short circuit protection
- CANopen Address: 1 to 100 by rotary switches
- Input Delay: 2.5ms default or configurable (through EDS)
- Input Device Supply: 200mA per port at 25° C
- Output Load Current: 2.0A max per channel, electronic short circuit protection
- Maximum Switching Frequency: 300 Hz
- Housing Dimensions: 30.00 by 175.00 by 20.00mm (1.18 by 6.89 by .78")
- Mounting Dimensions:
 - 23.00mm (0.91") horizontal on centers
 - 168.00mm (6.61") vertical on centers
- Operating Temperature: -25 to +70° C
- Storage Temperature: -40 to +85° C

No. of Power Pins	IO Configuration		Input Channel Type	Engineering No.	Standard Order No.
	Input	Output			
5	8		NPN	TBDCO-880N-804	112098-5006
	6	2	NPN	TBDCO-862N-804	112098-5004
	4	4	NPN	TBDCO-844N-804	112098-5002
	8		PNP	TBDCO-880P-804	112098-5007
	6	2	PNP	TBDCO-862P-804	112098-5005
	4	4	PNP	TBDCO-844P-804	112098-5003
		8	PNP	TBDCO-808P-804	112098-5001
		8 Universal (inputs or outputs)		PNP	TBDCO-8YYX-804

PICS Simulation® Software

112029

PICS PRO Software

PICS PRO Drivers

PICS PRO Software

PICS Simulation software simulates real-world systems and machines controlled by DCS, PLC and PC control systems. The entire system (communications, sequencing/interlocking, HMI/SCADA and alarms) can be tested, all emergency faults can be verified and operators trained, with minimal down-time.

PICS Simulation software enables you to identify and correct control system errors in the office, implement new processes quickly and accurately and avoid the high cost of production downtime before “flipping the switch.” PICS Simulation software provides your project team with a realistic and versatile testing and training environment.

How PICS Works

PICS Simulation software allows you to create a dynamic model on a PC that duplicates the behavior of the I/O devices, providing the control system with simulated device feedback.

PICS PRO can be used in Windows XP®, Vista® and 7 operating systems.

Features and Benefits

- Modern, customizable, visual development/debugging environment
- Ladder diagram editor for developing simulation logic (based on the IEC-61131-3 standard)
- Easy-to-use template editor for creating simulated devices and logic function blocks
- Device worksheets for graphically displaying the status of simulated devices and interacting with controls
- Importing I/O variables from popular PLC programming packages or from any delimited file format using the Import Wizard
- Editable scenarios for restoring or setting a simulation to a specific state greatly simplifies problem re-creation
- Faster startups—typically save up to 30% of the overall project programming, installation and debugging time
- Eliminate software bugs earlier in the project by locating and correcting software problems 10 to 20 times faster in a simulated environment
- Reduce downtime and project risk by installing tested and proven software
- Minimize project scheduling and cost uncertainties associated with debugging control logic problems
- Improved operator training because operators can gain valuable experience running production on the “live” control system in a simulated environment
- Training sessions can include emergency scenarios that would be too dangerous using the actual equipment

Product Description	Engineering No.	Standard Order No.
PICS Simulation on CD and USB hardware key	SST-PICS-PRO-U	112029-0027
Allen-Bradley® 1771 Remote I/O (requires SST-DHP-PCI card)	PICS-PRO-AB	112029-0008
PROFIBUS DP I/O (requires SST-PBMS-PCI card)	PICS-PRO-PBMS	112029-0012
OPC Server (OPC client software ordered separately)	PICS-PRO-OPC	112029-0011

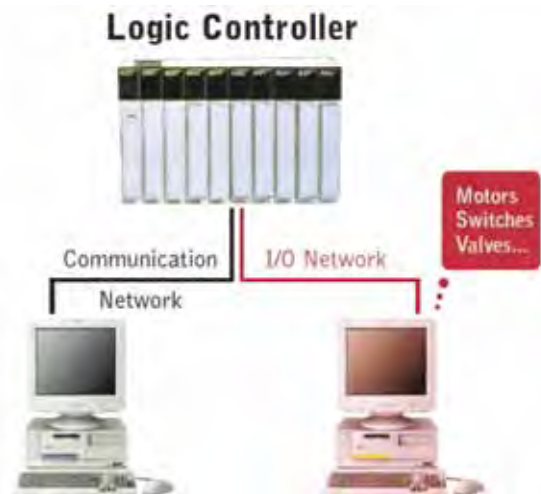

NMEA 2000* Brad Connectors and Cables

NMEA

Molex enables the NMEA 2000 physical layer for marine data network communication

Molex designs, manufactures and supports a complete line of open standard cables, cable assemblies, connectors, terminators and power products supporting the NMEA 2000 system. NMEA 2000 is a low-cost data network operating at 250 Kbps and utilizing the Controller Area Network (CAN) integrated circuit (IC). It allows multiple electronic devices to be connected together on a common channel for the purpose of easily sharing information.

The NMEA 2000 cables and connectors are available in two styles: the Mini-Change® for thick backbones and the Micro-Change® for thin backbones.

Brad Mini-Change® NMEA 2000 Network

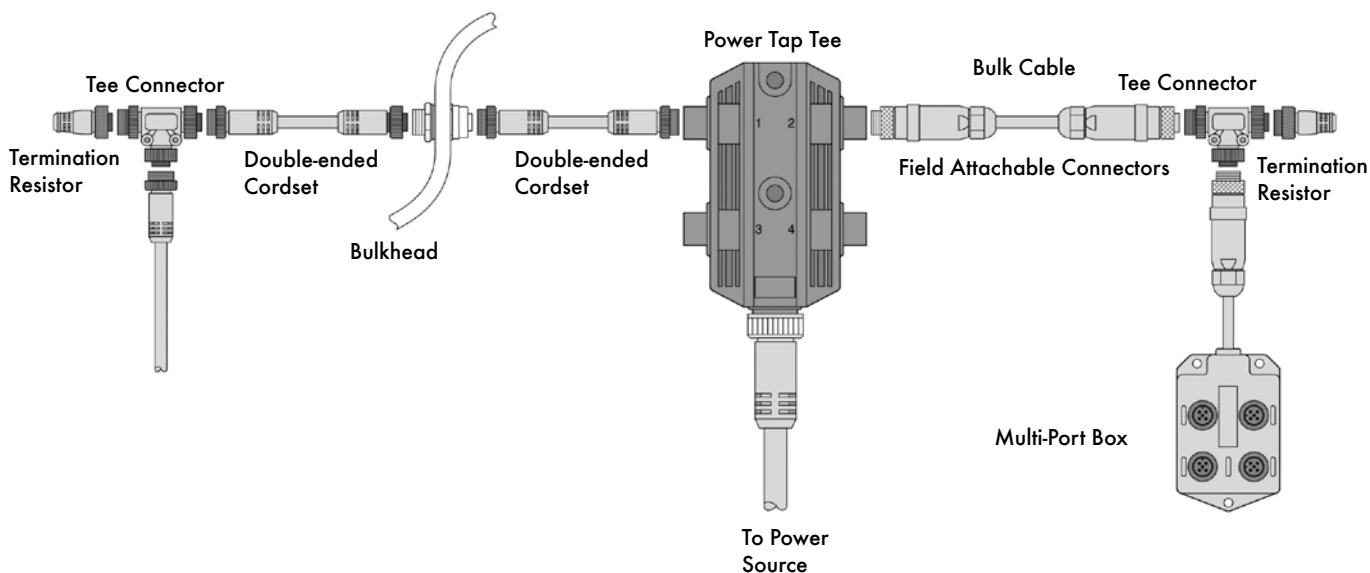

Brad Micro-Change® NMEA 2000 Network

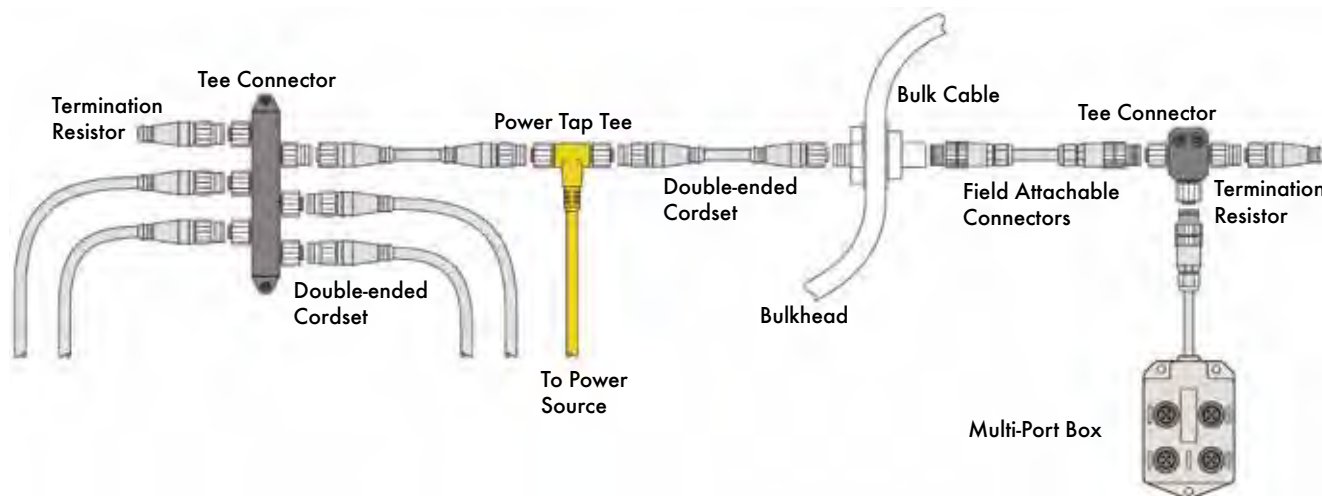

* NMEA 2000 is a trademark of the National Marine Electronics Association

NMEA 2000* Brad® Thick Bulk Cables

84695
Bulk Cable



Features and Benefits

- Meets or exceeds ODVA specifications for highest system reliability

Reference Information

UL: Type CL2, VL 1581 flame resistance
CSA: AWM I/II and A/B FT4

Overall

Rating: 300V, 80° C
Materials: Power—Gray PVC outer jacket, PVC with nylon skin inner insulation
Data—PE foam inner insulation
Construction: Two shielded pairs with 18 AWG (19x30 AWG) drain wire between pairs

Power Pair

Wire: Two 15 AWG (19x28 AWG) stranded tinned Copper
Shielding: Aluminum outside/polyester tape 25% overlap
DC resistance: 3.6 ohms/1000 ft max. at 20° C
Current: 8.0A
Color Code: Red/Black

Data Pair

Wire: Two 18 AWG (19x28 AWG) stranded tinned Copper
Shielding: Aluminum outside/polyester tape 25% overlap
DC Resistance: 6.92 ohms/1000 ft max. at 20° C
Capacitance: 12pF/ft
Color Code: White/Blue

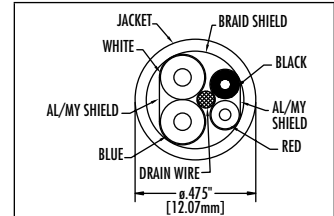

Comments	Wire Size AWG	Wire Cable Type	Standard Order No.
15 AWG Power Pair, 18 AWG Data Pair	15/18	Thick	84695-9095

*NMEA is a trademark of the National Marine Electronics Association
Note: Sales drawings for all standard order numbers are available on molex.com

NMEA 2000* Brad® Thin Bulk Cables

84854
Bulk Cable



Features and Benefits

- Meets and exceeds ODVA specifications for the highest reliability
- Standard thin or drop line cable

Reference Information

UL: CL2, AWM 2464
CSA: FT4 rated

Overall

Rating: 300V 80° C
Materials: Power—PVC outer jacket with semirigid PVC inner insulation
Data—PE foam inner insulation
Construction: Two shielded pairs, 22 AWG Tin-Copper drain wire between pairs
Cable Jacket Color: Gray

Power Pair

Wire: Two 22 AWG individually tinned stranded Copper
Shielding: Aluminum foil shield, 25% overlap
DC Resistance: 16.5 ohms/1000 ft max. at 20° C
Current: 4.0A
Color Code: Red/Black

Data Pair

Wire: Two 22 AWG individually tinned stranded Copper
Shielding: Aluminum foil shield, 25% overlap
DC Resistance: 16.5 ohms/1000 ft max. at 20° C
Velocity of Propagation: 75%
Capacitance: 11pF/ft
Color Code: White/Blue

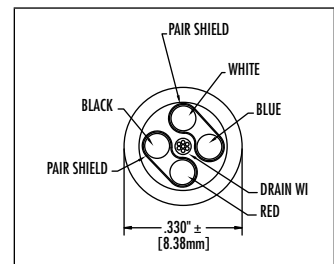

Comments	Wire Size AWG	Wire Cable Type	Standard Order No.
22 AWG Power Pair, 22 AWG Data Pair	22/22	Thin	84854-9316

Note: Sales drawings for all standard order numbers are available on molex.com
*NMEA 2000 is a trademark of the National Marine Electronics Association

NMEA 2000* Brad® Micro-Change® (M12) Single-Ended Cordsets

84854

**Female, Pigtail
Straight
Threaded**



Reference Information

NMEA 2000 Approved
UL File No.: E81982

Electrical

Current: 4.0A max.

Physical

Molded Connector: PVC
Coupling Ring: Brass, Nickel
Contacts: Copper alloy, Gold plated
Cable: PVC jacket, Gray
Wire: Two shielded pair 22 and 24 AWG with Copper drain wire between pairs
Operating Temperature: -20 to +80° C

Environmental

Protection: Designed and tested to IEC IP67 standard
Vibration: Complies with MIL-STD 202F, Test Method 204, Test Condition B
Corrosion: 300 hour salt spray protection per MIL-STD 202 Method 101

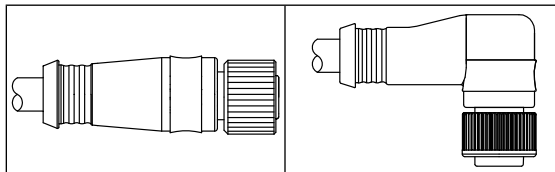

Face View	Length	Standard Order No.	
		Straight	Right Angle
<p>5 Pole</p> <p>1 - Drain 4 - CAN_H 2 - V+ 5 - CAN_L 3 - V-</p>	0.5m (1.64')	84854-7021	84854-7028
	1.0m (3.28')	84854-7022	84854-7029
	2.0m (6.56')	84854-7023	84854-7030
	3.0m (9.84')	84854-7024	
	4.0m (13.12')	84854-7025	84854-7031
	5.0m (16.40')	84854-7026	
	6.0m (19.69')	84854-7027	

Note: Sales drawings for all standard order numbers are available on molex.com
*NMEA 2000 is a trademark of the National Marine Electronics Association

NMEA 2000* Brad® Micro-Change® (M12) Single-Ended Cordsets

84854

**Male
Straight, Right Angle
Threaded**



Reference Information

NMEA 2000 Approved
UL File No.: E81982

Electrical

Current: 4.0A max.

Physical

Molded Connector: PVC
Coupling Ring: Brass, Nickel
Contacts: Copper alloy, Gold plated
Cable: PVC jacket, Gray
Wire: Brad Micro-Change—Two shielded pair 22 and
24 AWG with Copper drain wire between pairs
Operating Temperature: -20 to +80° C

Environmental

Protection: Designed and tested to IEC IP67 standard
Vibration: Complies with MIL-STD 202F, Test Method 204,
Test Condition B
Corrosion: Brad Micro-Change—300 hour salt spray
protection per MIL-STD 202 Method 101

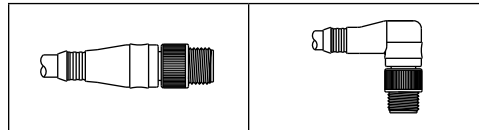

Circuits	Length	Male-Straight	Male-Right Angle
		Standard Order No.	Standard Order No.
<p>1 - Drain 4 - CAN_H 2 - V+ 5 - CAN_L 3 - V-</p>	0.5m (1.64')	84854-8021	84854-8028
	1.0m (3.28')	84854-8022	84854-8029
	2.0m (6.56')	84854-8023	84854-8030
	3.0m (9.84')	84854-8024	84854-8031
	4.0m (13.12')	84854-8025	84854-8031
	5.0m (16.40')	84854-8026	84854-8031
	6.0m (19.69')	84854-8027	84854-8031

Note: Sales drawings for all standard order numbers are available on molex.com
*NMEA 2000 is a trademark of the National Marine Electronics Association

NMEA 2000* Brad® Micro-Change® (M12) Double-Ended Cordsets

84854

**Female-to-Male
Straight
Threaded**



Reference Information

NMEA 2000 Approved
UL File No.: E81982

Electrical

Current: 4.0A max.

Physical

Molded Connector: PVC
Coupling Ring: Brass, Nickel
Contacts: Copper alloy, Gold plated
Cable: PVC jacket, gray
Wire: Brad Micro-Change—Two shielded pair 22 and 24 AWG with Copper drain wire between pairs
Operating Temperature: -20 to +80° C

Environmental

Protection: Designed and tested to IEC IP67 Standard
Vibration: Complies with MIL-STD 202F, Test Method 204, Test Condition B
Corrosion: 300 hour salt spray protection per MIL-STD 202 Method 101

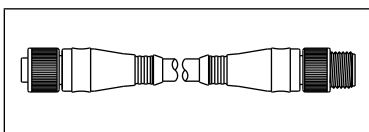

Circuits	Connection Type	Length	Standard Order No.
<p>1 - Drain 4 - CAN_H 2 - V+ 5 - CAN_L 3 - V-</p>	Male-to-Female	0.5m (1.64')	84854-6034
		1.0m (3.28')	84854-6035
		2.0m (6.56')	84854-6036
		3.0m (9.84')	84854-6037
		4.0m (13.12')	84854-6038
		5.0m (16.40')	84854-6039
		6.0m (19.69')	84854-6055
		7.0m (22.97')	84854-6041
		8.0m (26.25')	84854-6042
		9.0m (29.53')	84854-6043
10.0m (32.81')	84854-6044		

Note: Sales drawings for all standard order numbers are available on molex.com
*NMEA 2000 is a trademark of the National Marine Electronics Association

NMEA 2000* Brad® Micro-Change® (M12) Receptacles

84864
Female
Internal Thread



Reference Information

NMEA 2000 Approved
UL File No.: E81982

Electrical

Current: 4.0A max.

Physical

Coupling Ring: Brass, Nickel
Contacts: Copper alloy, Gold plated
Cable: PVC jacket, gray
Wire: Brad Micro-Change—Two shielded pair 22 and
24 AWG with Copper drain wire between pairs
Operating Temperature: -20 to +80° C

Environmental

Protection: Designed and tested to IEC IP67 Standard
Vibration: Complies with MIL-STD 202F, Test Method 204,
Test Condition B
Corrosion: 300 hour salt spray protection per MIL-STD 202
Method 101

Poles	Panel Mount	Female Single Ended (Pigtail) Straight	Female PCB Mount Straight	Female PCB Mount Right Angle
		Standard Order No.	Standard Order No.	Standard Order No.
<p>1 - Drain 4 - CAN_H 2 - V+ 5 - CAN_L 3 - V-</p>	Front	84864-9004	84864-9005	84864-9006

Note: Sales drawings for all standard order numbers are available on molex.com
*NMEA 2000 is a trademark of the National Marine Electronics Association

NMEA 2000* Brad® Micro-Change® (M12) Receptacles

84864
Male
External Thread



Reference Information

NMEA 2000 Approved
UL File No.: E81982

Electrical

Current: 4.0A

Physical

Molded Connector: PVC
Coupling Ring: Brass, Nickel
Contacts: Copper alloy, Gold plated
Cable: PVC jacket, gray
Wire: Brad Micro-Change—Two shielded pair 22 and
24 AWG with Copper drain wire between pairs
Operating Temperature: -20 to +80° C

Environmental

Protection: Designed and tested to IEC IP67 Standard
Vibration: Complies with MIL-STD 202F, Test Method 204,
Test Condition B
Corrosion: 300 hour salt spray protection per MIL-STD 202
Method 101

Poles	Panel Mount	Male Single Ended (Pigtail) Straight	Male PCB Mount Straight	Male PCB Mount Right Angle
		Standard Order No.	Standard Order No.	Standard Order No.
<p>1 - Drain 4 - CAN_H 2 - V+ 5 - CAN_L 3 - V-</p>	Front	84864-9001	84864-9002	84864-9003

Note: Sales drawings for all standard order numbers are available on molex.com
*NMEA 2000 is a trademark of the National Marine Electronics Association

NMEA 2000* Brad® Micro-Change® (M12) Field Attachable Connectors

084854

Female, Male
Straight



Features and Benefits

- Accepts a wide range of DeviceNet† cables for maximum installation flexibility
- Field termination for specific length or repair
- Internal and external threads
- Color-coded screw terminators make for error free field installation

Electrical

Voltage Rating: 36V DC
Current: 4.0A

Mechanical

Connector Face: Polyamide
Molded Body: Polyamide
Contact: Silver-plated Brass
Coupling Nut: Nickel-plated Brass
Grommet: Nitrite rubber
Cable Range OD: 0.160 to 32.00" OD (4.10 to 8.10mm)

Environmental

Protection: IP67

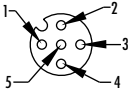
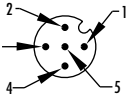
Poles	Coupling Type	Female Straight		Male Straight	
		Engineering No.	Standard Order No.	Engineering No.	Standard Order No.
 <p>5 Pole (Female View)</p> <p>1 - Silver (drain) 4 - White 2 - Red 5 - Blue 3 - Black</p>	Internal Thread	848549317	84854-9317		
 <p>5 Pole (Male View)</p> <p>1 - Silver (drain) 4 - White 2 - Red 5 - Blue 3 - Black</p>	External Thread			848549318	84854-9318

Note: Sales drawings for all standard order numbers are available on molex.com

*NMEA 2000 is a trademark of the National Marine Electronics Association

†DeviceNet is a trademark of Open DeviceNet Vendor Association (ODVA).

NMEA 2000* Brad® Micro-Change® (M12) Terminator Resistors

84586/84854

Female, Male
Female-to-Male
Straight

Features and Benefits

- Phosphor Bronze contacts for greatest reliability
- Used to terminate end of data line

Electrical

Voltage: 50V
Current: 4.0A

Physical

Connector Face: Micro-Change—Nylon
Molded Body: Diagnostic—Clear PVC
Standard—Gray PVC
Coupling Nut: Nickel-plated Brass
Contact Material: Phosphor Bronze alloy
Contact Plating: Gold over Copper alloy

Environmental

Protection: IP67

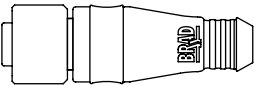
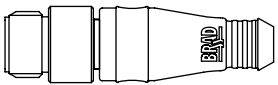
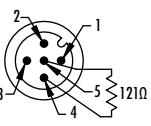
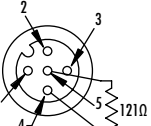

Poles (Female View)	Coupling Type	 	
		Female Straight Standard Order No.	Male Straight Standard Order No.
 <p>1 - no connection 4 - resistor 2 - no connection 5 - resistor 3 - no connection</p>	External Thread		84586-0018
 <p>1 - No connection 4 - Resistor 2 - No connection 5 - Resistor 3 - No connection</p>	Internal Thread	84586-0019	

Note: Sales drawings for all standard order numbers are available on molex.com

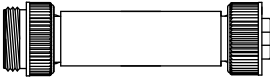
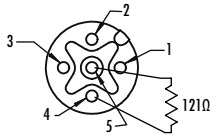
Poles (Female View)	Coupling Type		
		Female-to-Male Standard Order No.	
 <p>1 - No connection 4 - Resistor 2 - No connection 5 - Resistor 3 - No connection</p>	In-line	84854-9319	

Note: Sales drawings for all standard order numbers are available on molex.com

*NMEA 2000 is a trademark of the National Marine Electronics Association

NMEA 2000* Brad® Micro-Change® (M12) Bus Drop Tee

84586



Features and Benefits

- Phosphor Bronze contacts for greatest reliability
- Tees enable tapping into trunk line to add drop lines or devices

Electrical

Voltage: 250V
Current: 4.0A

Physical

Connector Face: Black PUR
Molded Body: Gray PUR
Coupling Nut: Nickel-plated Brass
O-Ring: Red Nitrile Rubber
Contact Material: Phosphor Bronze alloy
Contact Plating: Gold over Nickel alloy
Operating Temperature: 0 to 60° C

Environmental

Protection: IP67

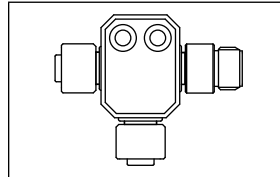

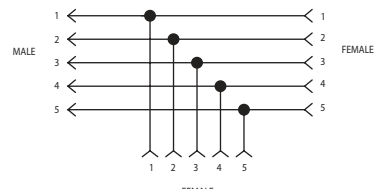
Face View	Wiring Schematic	Standard Order No.
<p>(Male View)</p> <p>5 Pole</p> 		<p>84586-0017</p>

Note: Sales drawings for all standard order numbers are available on molex.com
*NMEA 2000 is a trademark of the National Marine Electronics Association

NMEA 2000* Brad® Micro-Change® (M12) Power Tap Tees

84863
Female, Pigtail



Features and Benefits

- Rugged IP67 rated connectors bring power to active I/O modules reliably
- Variety of cable type, connector configuration and cable length options available for maximum flexibility

Electrical

Voltage Rating: 250V AC/DC
Amperage: 4.0A

Physical

Connector Face: Nylon 6/6
Molded Body: PVC
O-Ring: Nitrile Rubber
Coupling Nut: Nickel-plated Brass
Cable: Yellow 22 AWG PVC jacket and PFC conductor insulation over 26x36 AWG Copper standing, 300V, UL style 2661, CSA AWM I/II A/B, optional 80% Metallic braid
Outside Diameter: Without Braid—.20" (5.10mm)
With Braid—.25" (6.40mm)
Operating Temperature: -20 to +105° C

Environmental

Protection: IP67
NEMA Rating: NEMA 6

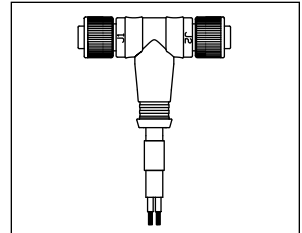

Poles (Female View)	Drop Gender	Left Trunk Gender	Right Trunk Gender	Standard Order No.
<p>5 Pole</p>	Pigtail	Female	Female	84863-9001
				84863-9002
				84863-9003

Note: Sales drawings for all standard order numbers are available on molex.com
*NMEA 2000 is a trademark of the National Marine Electronics Association

NMEA 2000* Brad® Micro-Change® (M12) Junction Boxes

84589

**Top Mount, 4-Port with
Molded Home Run Cable**



Features and Benefits

- Versions with home run connectors and with molded home run cable available for maximum system design flexibility
- Rugged housing and connectors designed to withstand harsh industrial environments

Electrical

Voltage Rating: 30V AC/DC
Current: 4.0A per port
12.0A max. per unit

Physical

Insert: PA
Housing: Glass-filled PBT
Housing (Receptacle): Nickel-plated Brass
ID Label: ABS
Home Run Cable: Brad Mini-Change®, thin
Home Run Connectors: Male, Brad Micro-Change
Operating Temperature: -25 to +90° C

Environmental

Protection: IP67
NEMA Rating: NEMA 6

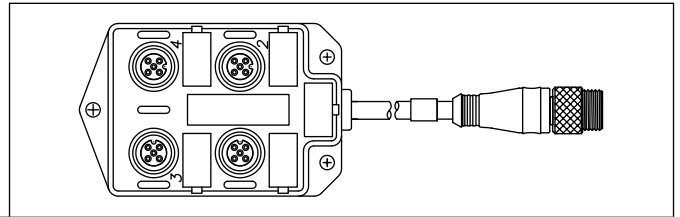

Poles (Female View)	Ports	Home Run Cable Length	Top Mount
			Standard Order No.
<p>5 Pole</p> <p>1 - Drain 4 - CAN_H 2 - V+ 5 - CAN_L 3 - V-</p>	4	0.5m (1.64')	84859-9001
		1.0m (3.28')	84859-9002
		2.0m (6.56')	84859-9003
		3.0m (9.84')	84859-9004

Note: Sales drawings for all standard order numbers are available on molex.com
*NMEA 2000 is a trademark of the National Marine Electronics Association

NMEA 2000* Brad® Mini-Change® Double-Ended Cordsets

84856

**Male-to-Female
Threaded**



Reference Information

NMEA 2000 Approved
UL File No.: E81982

Electrical

Current: 4.0A
Voltage: 300V

Physical

Molded Connector: PVC
Coupling Ring: Brass, Nickel
Contacts: Copper alloy, Gold plated
Cable: PVC jacket, Gray
Wire: Brad Mini-Change — Two shielded pair 18 and
15 AWG with copper drain wire between pairs
Power Pair — Red/Black
Data Pair — Blue/White
Operating Temperature: -20 to +80° C

Environmental

Protection: Designed and Tested to IEC IP67 Standard
Vibration: Complies with MIL-STD 202F, Test Method 204,
Test Condition B
Corrosion: Brad Mini-Change — 300 hour salt spray
protection per MIL-STD 202 Method 101

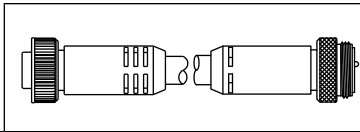

Poles (Female View)	Connection Type	Length	Standard Order No.
<p>5 Pole</p> <p>1 - Drain 4 - CAN_H 2 - V+ 5 - CAN_L 3 - V-</p>	Male-to-Female	0.5m (1.64')	84856-1200
		1.0m (3.28')	84856-1201
		2.0m (6.56')	84856-1202
		3.0m (9.84')	84856-1203
		4.0m (13.12')	84856-1204
		5.0m (16.40')	84856-1205
		6.0m (19.69')	84856-1206
		7.0m (22.97')	84856-1207
		8.0m (26.25')	84856-1208
		9.0m (29.53')	84856-1209
10.0m (32.81')	84856-1210		

Note: Sales drawings for all standard order numbers are available on molex.com
*NMEA 2000 is a trademark of the National Marine Electronics Association

NMEA 2000* Brad® Mini-Change® Field Attachable Connectors

084856

Female, Male
Straight



Features and Benefits

- Accepts a wide range of DeviceNet† cables for maximum installation flexibility
- Field termination for specific length or repair
- Internal and external threads
- Color-coded screw terminators make for error free field installation

Electrical

Voltage: 600V AC/DC
Current: 8.0A

Mechanical

Connector Face: Polyurethane
Connector Body: Polyamide
Contact: Gold-plated Brass
Coupling Nut: Nickel-plated Brass
Grommet: Neoprene
Cable Range OD: 0.20-0.48" (5.00-12.00mm)
Acceptable Wire Gauges: 24-15 AWG (0.25-2.0mm²)

Environmental

Protection: IP67

Poles	Coupling Type	Male Straight	Female Straight
		Standard Order No.	Standard Order No.
<p>5 Pole (Male View)</p> <p>1 - Drain silver 4 - White 2 - Red 5 - Blue 3 - Black</p>	External Thread	84856-9102	
<p>5 Pole (Female View)</p> <p>1 - Drain (silver) 4 - White 2 - Red 5 - Blue 3 - Black</p>	Internal Thread		84856-9101

Note: Sales drawings for all standard order numbers are available on molex.com
*NMEA 2000 is a trademark of the National Marine Electronics Association
†DeviceNet is a trademark of OpenDeviceNet Vendor Association (ODVA)

NMEA 2000* Brad® Mini-Change® Terminator Resistors

084856

**Male, Female
Straight**



Features and Benefits

- Phosphor bronze contacts for greatest reliability
- Diagnostics versions indicate power connection and correct polarity
- Used to terminate end of data line
- Trunk and drop versions
- LED diagnostic versions

Electrical

Voltage: 50V
Current: 8.0A

Physical

Connector Face: PVC
Molded Body: Diagnostic—Clear PVC
Standard—Gray PVC
Coupling Nut: Nickel-plated Brass
Contact Material: Phosphor Bronze alloy
Contact Plating: Gold over Copper alloy
LED: Green—Proper polarity
Red—Improper polarity

Environmental

Protection: IP67

Poles (Female View)	Coupling Type	Diagnostics/LEDs	Male Straight		Female Straight	
			Engineering No.	Standard Order No.	Engineering No.	Standard Order No.
<p>1 - No connection 4 - Resistor 2 - No connection 5 - Resistor 3 - No connection</p> <p>1 - No connection 4 - Resistor 2 - No connection 5 - Resistor 3 - No connection</p>	External Thread	No	N/A	84856-9108		
	External Thread				N/A	84856-9109
	Internal Thread	Yes	N/A	84856-9110		
	Internal Thread				N/A	84856-9111

Note: Sales drawings for all standard order numbers are available on molex.com
*NMEA 2000 is a trademark of the National Marine Electronics Association

NMEA 2000* Brad® Mini-Change® Bus Drop Tee

084856



Features and Benefits

- Phosphor bronze contacts for greatest reliability
- Tees enable tapping into trunk line to add drop lines or devices

Physical

Connector Face: TPE
Molded Body: TPE
Coupling Nut: Nickel-plated Brass
Contact Material: Phosphor Bronze Alloy
Contact Plating: Gold over Nickel Alloy

Environmental

Protection: Mini-Change—IP67
Micro-Change®—IP67

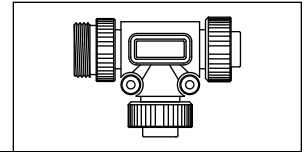

Face View (Female)	Max. Current per Contact	Max. Voltage	Drop Connector	Left Trunk Connector	Right Trunk Connector	Standard Order No.
	8.0A	600V	Mini-Change	Mini-Change	Mini-Change	84856-9104

Note: Sales drawings for all standard order numbers are available on molex.com

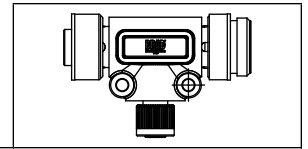

Face View (Male)	Max. Current per Contact	Max. Voltage	Drop Connector	Left Trunk Connector	Right Trunk Connector	Standard Order No.
	4.0A	300V	Micro-Change (M12)	Mini-Change	Mini-Change	84856-9105

Note: Sales drawings for all standard order numbers are available on molex.com

*NMEA 2000 is a trademark of the National Marine Electronics Association

NMEA 2000* Brad® Mini-Change® Power Tap

84856

Male Drop-to-Female/Female



Features and Benefits

- Connects power supply to trunk line in convenient plug/play fashion
- Easily replaceable fuses to protect bus and connected components from excessive current
- Provides LED status indication of power and correct polarity connection for simple diagnostics

Electrical

Voltage Rating: 50V DC
Fuse Protection: 4.0A
Grounding: 10-32 Screw

Physical

Insert: Nylon 6/6
Housing: PBT
Receptacle Housing: Zinc diecast with black epoxy coat
ID Label: ABS
Mounting: 2PTS, 0.290" (7.37mm)
Operating Temperature: -29 to +70° C

Environmental

Protection: IP67

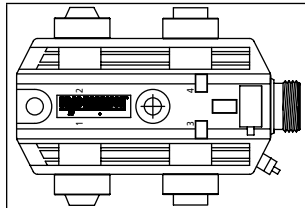

Face View (Female)	Standard Order No.
<p>Left Bus-In Female</p> <p>1 - Drain 4 - CAH_H 2 - V+ 5 - CAH_L 3 - V-</p>	84856-9112
<p>Drop Power</p> <p>1 - Vaux- 3 - Vaux+ 2 - no connection 4 - no connection</p>	
<p>Right Bus-Out Female</p> <p>1 - Drain 4 - CAH_H 2 - V+ 5 - CAH_L 3 - V-</p>	

Note: Sales drawings for all standard order numbers are available on molex.com
*NMEA 2000 is a trademark of the National Marine Electronics Association

NMEA 2000* Brad® Mini-Change® Auxiliary Power Single-Ended Cordsets

84856

Female



Features and Benefits

- Rugged IP68 rated connectors bring power to active I/O modules reliably
- Variety of cable type, connector configuration and cable length options available for maximum flexibility

Electrical

Voltage Rating: 600V AC/DC
Amperage: 10.0A

Physical

Connector Face: PVC-UL Std 94-V0
Molded Body: PV-UL Std 94-V0
Coupling Nut: Zinc diecast with black epoxy coat, optional stainless Steel type 303 or Nickel-plated Brass
Cable: Yellow, 16 AWG, PVC jacket, PVC conductor insulation over 65x34 AWG Copper stranding, UL STOOW CSA ST
Cable Diameter: 0.42" (10.77 mm)
Operating Temperature: -20 to +105° C

Environmental

Protection: IP68
NEMA Rating: NEMA 6P

Poles (Female View)	Length	Standard Order No.
<p>4 Pole</p> <p>1 - Black 3 - Red 2 - White 4 - Green-yel</p>	1.0m	84856-9113
	5.0m	84856-9114
	10.0m	84856-9115

Note: Sales drawings for all standard order numbers are available on molex.com
*NMEA 2000 is a trademark of the National Marine Electronics Association

NMEA 2000* Brad® Micro-Change® (M12)/ Brad Mini-Change® Bulkhead Feed-Through Receptacles

84854/84856

Male-to-Female
Straight



Reference Information

NMEA 2000 Approved
UL File No.: E81982

Physical

Molded Connector: PVC
Coupling Ring: Brass, Nickel
Contacts: Copper alloy, Gold plated
Cable: PVD jacket, gray
Wire: Brad Micro-Change—Two shielded pair 22 and
24 AWG with Copper drain wire between pairs
Operating Temperature: -20 to 80° C

Environmental

Protection: Designed and tested to IEC IP67 Standard
Vibration: Complies with MIL-STD 202F, Test Method 204,
Test Condition B
Corrosion: Brad Micro-Change—300 hour salt spray
protection per MIL-STD 202 Method 101

Poles (Female View)	Max. Current per Contact	Max. Voltage	Mounting Thread Size	Coupling Type	Male-Female Brad Micro-Change (M12)	Male-to-Female Brad Mini-Change
					Standard Order No.	Standard Order No.
<p>Mini-Change 5 Pole</p>	4.0A	250V AC/DC	M12 X 1.0	External Thread	84854-9300	
<p>Micro-Change 5 Pole</p>	8.0A	600V AC/DC	7/8" - 16 Un-2A			84856-9103

Note: Sales drawings for all standard order numbers are available on molex.com
*NMEA 2000 is a trademark of the National Marine Electronics Association

NMEA 2000* Brad® Micro-Change® (M12) and Mini-Change® Closure Caps

84854/84856

Female, Male
Straight, Threaded



Micro-Change (M12)	Standard Order No.
For Female Connector	84854-9019

Mini-Change	Standard Order No.
For Female Connector	84856-9106
For Male Connector	84856-9107

Note: Sales drawings for all standard order numbers are available on molex.com
*NMEA 2000 is a trademark of the National Marine Electronics Association

Industrial USB Plugs and Receptacles

Industrial USB connectors bring one of the most popular and convenient I/O connectors into harsh commercial and industrial environments

Many industrial devices and networks use a direct interface to a PC for programming, monitoring, data collection and diagnostics of the industrial bus. Molex's sealed, industrial Universal Serial Bus (USB) connectors are ideal for industrial and harsh commercial applications, where a secure and robust connection is required. The rugged, plug and receptacle designs feature bayonet-style latches, encapsulated PCB receptacles and overmolded cable assemblies to help keep out dust, debris and water.

USB connectors are ideal for both short-term diagnostics that require simple and fast setup, and permanent installations for data acquisition systems. Once software has been installed, USB plugs and receptacles can be quickly connected and disconnected from various devices without having to turn off computers or equipment. High performance results and ease-of-use make industrial USB from Molex a valuable solution for a variety of harsh environment applications.

For more information on Industrial USB Plugs and Receptacles, please visit: www.molex.com/product/industrialusb.html.

Features and Benefits

- IP67 and NEMA 6P ratings ensure cordsets are water and dust tight for functional integrity
- Overmolded cordsets allow for faster installation at customer site versus field-wireable designs
- Bayonet-style latch receptacle provides quick and easy connection and ensures proper insertion depth with mating
- Cordsets available in varied lengths up to 5.00m (16.40') which allows customers to choose the length convenient for their specific application
- Fully shielded cable provides Electro-magnetic Interference/Radio Frequency Interference (EMI/RFI) protection



Applications

- Factory Automation
 - Industrial Computers
 - Industrial Controllers
 - Factory Peripherals
 - Printers
 - Barcode Scanners
- Robotics
- Vision Systems
- Motion and Process Controls
- Test and Measurement Equipment
- Medical Devices
- Factory Networking Installations
- Production Equipment

Industrial USB Brad® Shielded Overmolded Cordset

84732

Double Ended Bayonet Style Type-A Plug to Bayonet Style Type-B Plug



Order No.	Length	Lead-free
84732-0001	0.80m (2.62')	Yes
84732-0002	1.50m (4.92')	
84732-0003	2.0m (6.56')	
84732-0004	3.0m (9.84')	
84732-0005	5.0m (16.40')	

Features and Benefits

- Standard USB shielded I/O system in a rugged, industrial sealed package
- Fully shielded for EMI/RFI protection
- IP67 and NEMA 6P rated cable assemblies are water and dust tight for functional integrity
- Bayonet style latching provides audible and tactile confirmation of positive mating

Reference Information

Packaging: Bag
Mates With: 84729 and 84730
Designed In: Inches
Flammability: UL 94V-0
Performance: USB 2.0

Electrical

Voltage: 30V
Current: 1.0A
Contact Resistance: 30 milliohms max.
Dielectric Withstanding Voltage: 750V AC
Insulation Resistance: 1000 Megohms min.

Mechanical

Mating Force: 35N (7.87 lb) max.
Withdrawal Force: 10N (2.25 lb) min.
Durability: 1000 mating cycles

Physical

Overmolding: PVC, black
Coupling Ring: Polyester, black
Contact: Copper alloy
Plating: Contact Area—0.75µm (30µ") Gold
Underplating—Nickel
Gasket Seal: Nitrile, black
Operating Temperature: 0 to +70° C

Industrial USB Brad® Shielded Overmolded Cordset

84727

Bayonet Style Type-A Plug to Shielded Pigtail



Order No.	Length	Lead-free
84727-1005	0.15m (.49')	Yes
84727-1002	1.50m (4.92')	
84727-1001	2.0m (6.56')	
84727-1003	3.0m (9.84')	
84727-1004	5.0m (16.40')	

Features and Benefits

- Standard USB shielded I/O system in a rugged, industrial sealed package
- Fully shielded for EMI/RFI protection
- IP67 and NEMA 6P rated cable assemblies are water and dust tight for functional integrity
- Bayonet style latching provides audible and tactile confirmation of positive mating
- Compliance with USB 2.0 specification

Reference Information

Packaging: Bag
Mates With: 84729
Designed In: Inches
Flammability: UL 94V-0
Performance: USB 2.0

Electrical

Voltage: 30V
Current: 1.0A
Contact Resistance: 30 milliohms max.
Dielectric Withstanding Voltage: 750V AC
Insulation Resistance: 1000 Megohms min.

Mechanical

Mating Force: 35N (7.87 lb) max.
Withdrawal Force: 10N (2.25 lb) min.
Durability: 1000 mating cycles

Physical

Overmolding: PVC, black
Coupling Ring: Polyester, black
Contact: Copper alloy
Plating: Contact Area—0.75µm (30µ") Gold
Underplating—Nickel
Gasket Seal: Nitrile, black
Operating Temperature: 0 to +70° C

Industrial USB Brad® Shielded Overmolded Cordset

84728

**Bayonet Style Type-B
Plug-to-Pigtail**



Features and Benefits

- Standard USB shielded I/O system in a rugged, industrial sealed package
- Fully shielded for EMI/RFI protection
- IP67 and NEMA 6P rated cable assemblies are water and dust tight for functional integrity
- Bayonet style latching provides audible and tactile confirmation of positive mating
- Compliance with USB 2.0 specification

Reference Information

Packaging: Bag
Mates with: 84730
Designed In: Inches
Flammability: UL 94V-0
Performance: USB 2.0

Electrical

Voltage: 30V
Current: 1.0A
Contact Resistance: 30 milliohms max.
Dielectric Withstanding Voltage: 750V AC
Insulation Resistance: 1000 Megohms min.

Mechanical

Mating Force: 35N (7.87 lb) max.
Withdrawal Force: 10N (2.25 lb) min.
Durability: 1000 mating cycles

Physical

Overmolding: PVC, black
Coupling Ring: Polyester, black
Contact: Copper alloy
Plating: Contact Area—0.75µm (30µ") Gold
Underplating—Nickel
Gasket Seal: Nitrile, black
Operating Temperature: 0 to +70° C

Order No.	Length	Lead-free
84728-1005	0.15m (.49')	Yes
84728-1002	1.50m (4.92')	
84728-1001	2.0m (6.56')	
84728-1003	3.0m (9.84')	
84728-1004	5.0m (16.40')	

Industrial USB Brad® Shielded Overmolded Cordset

84729

**Bayonet Style
Type-A Sealed Panel Mount
Receptacle to Standard Type-A
Plug**



Features and Benefits

- Standard USB shielded I/O system in a rugged, industrial sealed package
- Fully shielded for EMI/RFI protection
- IP67 and NEMA 6P rated cable assemblies are water and dust tight for functional integrity
- Bayonet style latching provides audible and tactile confirmation of positive mating
- Compliance with USB 2.0 specification

Reference Information

Packaging: Bag
Mates With: 84727 and 84732
Designed In: Inches
Flammability: UL 94V-0
Performance: USB 2.0

Electrical

Voltage: 30V
Current: 1.0A
Contact Resistance: 30 milliohms max.
Dielectric Withstanding Voltage: 750V AC
Insulation Resistance: 1000 Megohms min.

Mechanical

Lock Nut Destructive Torque: 2.71Nm (24 in. lb) or more
Mating Force: 35N (7.87 lb) max.
Withdrawal Force: 10N (2.25 lb) min.
Durability: 1000 mating cycles

Physical

Overmolding: PVC, black
Receptacle Housing: PBT, black
Lock Nut: PBT, black
Contact: Copper alloy
Plating: Contact Area—0.75µm (30µ") Gold
Underplating—Nickel
Panel Gasket: Neoprene, black
Operating Temperature: 0 to +70° C

Order No.	Length	Lead-free
84729-0003	0.152m (.498')	Yes
84729-0004	0.8m (2.62')	
84729-0005	1.50m (4.92')	
84729-0006	2.0m (6.56')	
84729-0007	3.0m (9.84')	
84729-0008	5.0m (16.40')	

Industrial USB Brad® Panel Mount PCB Receptacle

84729/84730
Bayonet Style



Order No.	Description	Lead-free
84729-0009	USB Type A	Yes
84730-0010	USB Type B	

Features and Benefits

- Standard USB shielded I/O system in a rugged, industrial sealed package
- Fully shielded for EMI/RFI protection
- IP67 and NEMA 6P rated cable assemblies are water and dust tight for functional integrity
- Bayonet style latching provides audible and tactile confirmation of positive mating
- Compliance with USB 2.0 specification ensures compatibility with standard USB cables

Reference Information

Packaging: Bag
 Mates With: Type A—84727 and 84732
 Type B—84728 and 84732
 Designed In: Inches
 Flammability: UL 94V-0
 Performance: USB 2.0

Electrical

Voltage: 30V
 Current: 1.0A
 Contact Resistance: 30 milliohms max.
 Dielectric Withstanding Voltage: 750V AC
 Insulation Resistance: 1000 Megohms min.

Mechanical

Lock Nut Destructive Torque: 2.71Nm (24 in. lb) or more
 Mating Force: 35N (7.87 lb) max.
 Withdrawal Force: 10N (2.25 lb) min.
 Durability: 1000 mating cycles

Physical

Receptacle Housing: PBT, black
 Lock Nut: Polyamide 6/6, black
 Contact: Copper alloy
 Plating: Contact Area—0.75µm (30µ") Gold
 Underplating—Nickel
 Gasket Seal: Neoprene, black
 Operating Temperature: 0 to +70° C

Industrial USB Brad® Type-A Panel Mount Receptacle

84729
Bayonet Style to
5-Circuit Pigtail



Order No.	Length	Lead-free
84729-0001	0.15m (.49')	Yes

Features and Benefits

- Standard USB shielded I/O system in a rugged, industrial sealed package
- Fully shielded for EMI/RFI protection
- IP67 and NEMA 6P rated cable assemblies are water and dust tight for functional integrity
- Bayonet style latching provides audible and tactile confirmation of positive mating
- Compliance with USB 2.0 specification

Reference Information

Packaging: Bag
 Mates With: 84727 and 84732
 Designed In: Inches
 Flammability: UL 94V-0
 Performance: USB 2.0

Electrical

Voltage: 30V
 Current: 1.0A
 Contact Resistance: 30 milliohms max.
 Dielectric Withstanding Voltage: 750V AC
 Insulation Resistance: 1000 Megohms min.

Mechanical

Lock Nut Destructive Torque: 2.71Nm (24 in. lb) or more
 Mating Force: 35N (7.87 lb) max.
 Withdrawal Force: 10N (2.25 lb) min.
 Durability: 1000 mating cycles

Physical

Receptacle Housing: PBT, black
 Lock Nut: Polyamide 6/6, black
 Contact: Copper alloy
 Plating: Contact Area—0.75µm (30µ") Gold
 Underplating—Nickel
 Gasket Seal: Neoprene, black
 Wire Gauge: 28 AWG
 Operating Temperature: 0 to +70° C

Industrial USB Brad® Bayonet Style Tethered Dust Cap

84700



Features and Benefits

- One sealing surface means less likelihood of failure
- Attachable tether so cap never gets lost
- Maintains IP67 and NEMA 6P ratings for functional integrity when connector is not mated
- IP67 and NEMA 6P ratings ensure cable assemblies are water and dust tight for functional integrity

Reference Information

Packaging: Bag

Use With: 84700, 84702, 84729, 84730

Designed In: Inches

Physical

Dust Cap: PBT, black

Tether: PE or PP, black

Gasket Seal: Nitrile, black

Screw: Brass, #8-32

Plating: Screw—Nickel

Operating Temperature: -40 to +85° C

Order No.	Description	Lead-free
84700-0003	Dust Cover	Yes

Cable Chemical Resistance Chart

Resistance To:	Cable Jacket Material			
	PVC	PUR	TPE	Rubber SJ- and SO
Oxidation	E	E	O	F
Heat	G-E	E	O	F
Oil	F	O	O	P
Low Temperature Flexibility	P-G	E	O	G
Weather, Sun	G-E	E	O	F
Ozone	E	E	E	P
Abrasion	F-G	E	E	E
Electrical Properties	F-G	E	E	G
Flame	E	E	O	P
Nuclear Radiation	F	E	P	F
Water	G-E	G-E	E	G
Acid	G-E	E	E	F-G
Alkali	G-E	E	E	F-G
Gasoline	P	E	E	P
Benzol, Tolulol (Aliphatic Hydrocarbons)	P-F	E	E	P
Degreaser Solvents (Haslogenated Hydrocarbons)	P-F	E	E	P
Alcohol (Halogenated Hydrocarbons)	G-E	E	E	G
Weld Slag	F	E	E	O

P=Poor, F=Fair, G=Good, E=Excellent, O=Outstanding

Note: These relative ratings are based on average performance. Special selective compounding of the jacket can improve the performance.

Specifications and Wire Diameters American Wire Gauge (AWG)

AWG	Strands	Nominal OD of Strand (mm)	Approximate OD (mm)	Circular MIL Area	Weight LBS. per 1000 ft	Maximum Resistance OHMS per 1000 ft
10	105/30	.0100	.120	10552	32.5	1.15
10	49/27	.0142	.116	10445	32.6	1.21
10	37/26	.0159	.107	9402	29	1.26
12	165/34	.0063	.095	6549	19.8	1.58
12	65/30	.0100	.095	6533	20.8	1.85
12	19/25	.0179	.089	6088	18.8	1.92
12	7/20	.0320	.096	7168	21.6	1.45
14	105/34	.0063	.086	4173	13	2.49
14	41/30	.0100	.074	4121	12.7	2.94
14	19/27	.0142	.069	3829	11.9	3.05
16	105/36	.0050	.065	2625	8.1	3.99
16	65/34	.0063	.063	2584	8	4.02
16	26/30	.0100	.059	2613	8	4.59
16	19/29	.0113	.054	2426	7.5	4.82
16	7/24	.0201	.060	2628	8.6	3.7
18	65/36	.0050	.051	1625	5	6.4
18	41/34	.0063	.052	1629	5	6.37
18	19/30	.0100	.048	1608	4.9	6.22
18	16/30	.0100	.049	1608	4.9	6.60
18	7/26	.0159	.048	1770	5.5	6.54
20	41/36	.0050	.038	1025	3.2	10.02
20	26/34	.0063	.040	1033	3.2	10.05
20	19/32	.0080	.038	1201	3.7	9.76
20	10/30	.0100	.038	1005	3.1	11.8
20	7/28	.0126	.038	1119	3.5	10.4
22	26/36	.0050	.033	650	2	15.94
22	19/34	.0063	.033	754	2.3	15.9
22	7/30	.0100	.030	704	2.2	16.7
24	41/40	.0031	.0245	394	1.2	25.59
24	19/36	.0050	.024	475	1.5	25.4
24	10/34	.0063	.024	398	1.2	26.09
24	7/32	.0080	.024	448	1.4	23.3
26	19/38	.0040	.019	304	.92	40.1
26	10/36	.0050	.021	250	.77	41.48
26	7/34	.0063	.019	276	.85	42.6
28	19/40	.0031	.016	182	.563	67.7
28	7/36	.0050	.015	175	.539	68.2
30	19/42	.0025	.012	118	.359	87.3
30	7/38	.0040	.012	110	.34	108.00

Stranded Wire Cross-Reference

Standard Cable Length Tolerances

mm² to strand count
mm² to AWG

European Standards The system for flexible conductors (columns 3 and 4 below) centers around the maximum strand diameter and the conductor resistance. In view of this, some cables may have fewer strands and smaller diameter than listed below but still conform to BS 6360: 1981, VDE 0295 and IEC 228 by having the correct conductor resistance.

Cross Section (mm ²)	Strand 5 BS 6360 Class 2 (mm ²)	Multi-Wire Strand (mm ²)	Fine Wire Strands BS 6360 Class 5 VDE 0295 (mm ²)	Extra-Fine Strand BS 6360 Class 6 VDE 0295 (mm ²)
	Column 1	Column 2	Column 3	Column 4
0.05				
0.08				
0.14				18 x 0.10
0.25			14 x 0.16	32 x 0.10
0.34		7 x 0.25	19 x 0.16	42 x 0.10
0.38		7 x 0.27	12 x 0.21	21 x 0.16
0.5	7 x 0.30	7 x 0.30	16 x 0.21	28 x 0.16
0.75	7 x 0.37	7 x .037	24 x 0.21	42 x 0.16
1.0	7 x 0.43	7 x 0.43	32 x 0.21	56 x 0.16
1.5	7 x 0.52	7 x 0.52	30 x 0.26	84 x 0.16
2.5	7 x 0.67	19 x 0.41	50 x 0.26	140 x 0.16
4	7 x 1.05	19 x 0.52	56 x 0.31	224 x 0.16
6	7 x 1.05	19 x 0.64	84 x 0.31	192 x 0.21
10	7 x 1.35	49 x 0.51	80 x 0.31	321 x 0.21

Cable Cross-Reference—AWG to mm²

AWG	mm ²	AWG	mm ²	AWG	mm ²
30	0.05	21	0.38	16	1.5
28	0.08	20	0.50	14	2.5
26	0.14	18	0.75	12	4
24	0.25	17	1.0	10	6
22	0.34			8	10

Standard Cable Length Tolerances

Length of Assemblies (Feet)	Tolerance (Inches)	Length of Cable Assemblies (Meters)	Tolerance (CM)
> 1'	.75"	>.3m	1.91cm
1' - 3'	1.75"	.3m - .9m	4.45cm
3' - 6'	2.19"	.9m - 1.8m	5.56cm
6' - 12'	3.50"	1.8m - 3.7m	8.89cm
12' - 24'	6.50"	3.7m - 7.3m	16.51cm
24' - 48'	12.50"	7.3m - 14.6m	31.75cm
48' - 100'	24.50"	14.6m - 30.5m	62.23cm
over 100'	+2% of finished length	Over 30m	+2% of finished length

Note: Higher tolerance cable assemblies can be specified at additional cost

Approval Codes and Applicable Protection Standards

Standards as defined in the following section may apply to products or components found within this catalog. The user should always use the original standards and documents for interpretation. It is the responsibility of the user to determine the suitability of use for the products represented in this catalog.

ANSI/NFPA T3.5.29 R1-2007 American National Standards Institute generally defines the geometry and connection scheme of the "mini" type connectors used in fluid power (valve) applications. Automotive standard conductor colors, which are widely used on sensors, is the basis for this specification. The Mini-Change® type of connectors have their pins and conductor sizes defined for them for the 3 and 5 pin versions.

ASTM American Society of Testing and Materials, a standards organization which suggests test methods, definitions and practices.

AWM AWM cable is intended for the internal wiring factory-assembled, listed appliances such as computers, business machines, ranges, washers, dryers, radios, etc... In the past AWM cable was incorrectly used to wire buildings; this was never its intended use. In some cases AWM cable may be used for external connection. In these situations, the user should be aware that the AWM cable temperatures and voltage ratings may differ from the NEC ratings.

CENELEC EN 50 044

Section 1. Scope

This specification identifies connections for inductive proximity switches. It defines the conductor colors used on 2, 3 and 4 wire proximity switches. It also defines the numerical marking of the terminals, whether quick disconnect, or not.

Section 2. Execution of Proximity Switches

The proximity switches are distinguished by their execution: Proximity switches with integral connecting leads: the connection is identified by the color of the conductor. Proximity switches with connecting terminals for connection: the terminals are identified by numerical marking.

Section 3. Identification by color of the conductors

A protective conductor, if it exists, shall be identified according to IEC publication 446, i.e. green/yellow.

3.1 Unpolarized proximity switches for direct current or alternating current

The proximity switch is connected in series with the load: Unpolarized proximity switches, with two conductors, for direct current or alternating current, may have conductors of any color *except* green/yellow.

3.2 Polarized proximity switches for direct current supply

3.2.1. Proximity switches with two conductors

The proximity switch is connected in series with the load: The conductor for the plus (+) pole shall be BROWN, The conductor for the minus (-) pole shall be BLUE.

3.2.2. Proximity switches with three or four conductors

The conductors shall be identified as follows: Conductors for the supply voltage: BROWN for plus (+) pole, BLUE for the minus (-) pole. Conductors for the load output: The output conductor for three conductor devices shall be BLACK, whatever the function. The output conductor for four conductor devices shall be: BLACK for make operation, WHITE for break operation.

Section 4. Identification by numerical marking of the terminals

The terminal for a protective conductor, if it exists, shall be marked according to IEC publication 445.

4.1. Unpolarized proximity switches for direct current or alternating current

The proximity switch is connected in series with the load. For unpolarized proximity switches with two terminals, for direct current or alternating current, the terminals shall be marked as follows:

3 and 4 for make operation,
1 and 2 for break operation

4.2 Polarized proximity switches for direct current supply

4.2.1. Proximity switches with two terminals

The proximity switch is connected in series with the load. The terminal for the plus (+) pole shall be marked 1, the terminal for the minus (-) pole shall be marked:

4 for make operation
2 for break operation

4.2.2. Proximity switch with three or four terminals

The terminals shall be marked as follows: Terminals for supply voltage:

1 for the plus (+) pole,
3 for the minus (-) pole

Terminals for the load output

4 for make operation
2 for break operation

CE The CE mark cannot and must not be applied to electronic components of which cables, cordsets and connectors are a part. The latest rules for CE marking in accordance with the low-voltage Directive (73/23/EEC-July 1997) state that electronic components are exempted from the scope of application of the Low-voltage directive. Instead manufacturers of equipment must comply with the appropriate EC directives applicable to the machine and electrical subsystems as a whole for CE compliance.

CSA Government run laboratory that tests products to ensure conformity to a set of standard tests as defined by this body. Similar to UL standards in the US.

DIN 43560 Defines the mechanical geometry and other characteristics of the rectangular style of connectors most frequently found on hydraulic and pneumatic valves in the fluid power industry.

FT 1 Vertical Flame Test per CSA C22.2

No 0.3-92 Para 4.11.1 A finished cable shall not propagate a flame or continue to burn for more than (1) minute after five (5) fifteen (1) second applications of the flame. There is an interval of fifteen (15) seconds between the flame applications. The flame test shall be performed in accordance with Para 4.11.1 of the CSA Standard C22.2 No 0.3. In addition, if more than 25% of the indicator flag is burned, the test cable fails.

FT 4 Vertical Flame Test - Cables in Cable Trays per CSA C22.2

No 0.3-92 Para 4.11.1 Similar to the UL 1581 Vertical Flame Test, but is more severe. The FT 4 Test has its burner mounted at 20 degrees from the horizontal with the burner post facing up. The UL-1581 Vertical Tray has its burner at 0 degrees from the horizontal. The FT 4 samples must be larger than the 13mm (0.512") in diameter. If not, then the cable samples are grouped in units of at least (3) to obtain a grouped overall diameter of 13mm. The UL-1581 Vertical Tray does not distinguish on cable size. The FT 4 has a maximum char height of 1.5m (59") measure from the lower edge of the burner face. The UL-1581 has a flame height allowable up to approximately 78" measured from the burner.

FT 6 Horizontal Flame and Smoke Test per CSA C22.2

No 0.3-92 Appendix B Cables passing the FT 6 Horizontal Flame and Smoke Test are designated FT 6 in the column where the trade number appears. This test is in accordance with ANSI/NFPA Standard 262-1985 (UL-910). The maximum flame spread shall be 1.50 meters (4.92 feet). The smoke density shall be 0.5 at peak optical density and 0.15 at maximum average optical density.

IEC Protection Classes (See chart on following page)

IP 40 Protection against solid bodies larger than 1mm. No liquid protection defined.

IP 65 Dust tight. Protection against water spray from all directions at 43 PSI through a 12mm nozzle.

IP 67 Dust tight. Protection against the effects of immersion in water for 30 minutes at a depth of 1 meter.

IP 68 Dust tight. Protection against the effects of indefinite immersion in water at a pressure specified by the manufacturer. The manufacturer's specifications must be known if a valid comparison is to be made.

IP 69K Dust tight. Protection against high-pressure (8-10MPa) and high-temperature (80° C) water spray (wash down).

National Electrical Code Although the NEC covers wire and cable installed in factories, office buildings, etc as well all cable which pass through any floor, wall ceiling or which travel in ducts, plenums and other air handling spaces, each individual municipality, city, county or state can decide whether or not they wish to adopt the NEC as governing law.

NFPA (National Fire Protection Association)

NEMA (National Electrical Manufacturers Association) Defines the degree of protection in the actual test specifications.

NEMA 1 Enclosures are intended for use primarily to provide a degree of protection against limited amounts of falling dirt.

NEMA 3 Enclosures are intended for outdoor use primarily to provide a degree of protection against windblown dust, rain, sleet and external ice formation.

NEMA 4 Enclosures are intended for indoor or outdoor use primarily to provide a degree of protection against windblown dust, rain, sleet, splashing water, hosedown and external ice formation.

NEMA 6 Enclosures are intended for indoor or outdoor use primarily to provide a degree of protection against the entry of water during occasional temporary submersion at a limited depth.

NEMA 6P Enclosures are intended for indoor or outdoor use primarily to provide a degree of protection against the entry of water during prolonged submersion at a limited depth.

UL and UR Designated Underwriters Laboratories "UL Listed" and "UL Recognized," respectively. UL is a nationally recognized laboratory that tests many products to meet safety standards that are defined in their own and other industry specifications.

VDE 0100 Defines the minimum creepage distances of the equipment to prevent hazardous electrical current and voltage for persons and objects. Isolation Class C includes the equipment mainly designed for industrial and agricultural applications in warehouses without heating, in workshops or machine tools.

VW-1 A flammability rating established by Underwriters Laboratories for wires and cables that pass a specially designed vertical flame test.

Pin Numbering Conventions





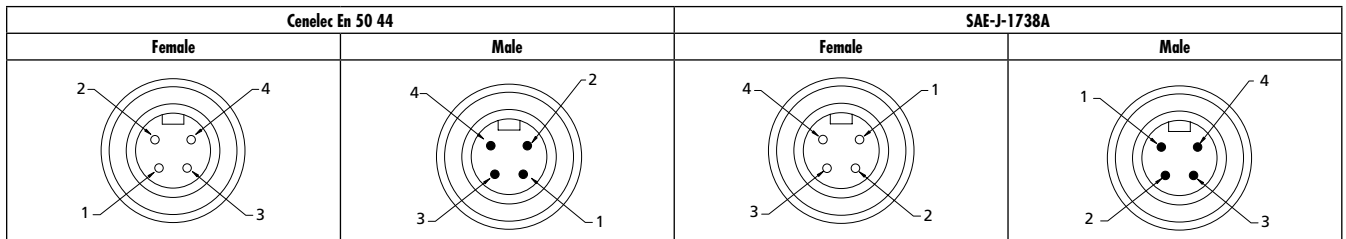







There are two conventions that determine which PIN numbers are located with respect to the keyway. These are CENELEC EN 50 044 and SAE-J-1738A.

In almost every case, except for 4-pole Mini-Change® connections, these two conventions agree with one another. This affects DeviceNet™ installations where the 4-pole Mini-Change connector is used to bring auxiliary power to I/O modules and other devices.

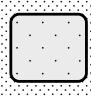
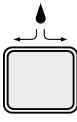

Approval Codes and Applicable Protection Standards

IP Ratings Table—Definition

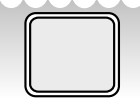
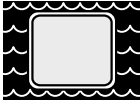
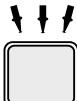
Code Letter (International Protection)		First Index Figure (Foreign Bodies Protection)		Second Index Figure (Water Protection)			
IP		6		5			
INDEX FIGURE	DEGREE OF PROTECTION		INDEX FIGURE	DEGREE OF PROTECTION			
0	No Protection		No Protection against accidental contact, no protection against foreign bodies	0	No protection		No Protection against water
1	Protection against large foreign bodies		Protection against contact with any large area by hand and against large solid bodies with $\varnothing > 50\text{mm}$	1	Drip-Proof		Protection against vertical water drips
2	Protection against medium sized foreign bodies		Protection against contact with the fingers, protection against small foreign solid bodies with $\varnothing > 12\text{mm}$	2	Drip-Proof		Protection against water drips (up to a 15° angle)
3	Protection against small solid foreign bodies		Protection against tools wires, or similar objects with $\varnothing > 2.5\text{mm}$. Protection against small foreign solid bodies with $\varnothing > 2.5\text{mm}$	3	Spray-proof		Protection against water drips (up to a 60° angle)
4	Protection against grainshaped foreign bodies		As 3 however $\varnothing > 1\text{mm}$	4	Spray-proof		Protection against splashed water from all directions
5	Protection against deposits of dust		Full protection against contact. Protection against interior equipment damage due to dust deposits	5	Hose-proof		Protection against splashed water (out of a nozzle) from all directions
6	Protection against ingress of dust		Total protection against contact. Protection against penetration of dust	6	Protected against flooding		Protection against temporary flooding
\varnothing =diameter of foreign body				7	Protected against immersion		Protected against temporary immersion
				8	Water-tight		Protected against water pressure
				9K	Protection against high-pressure and high-temperature water		Protection against high-pressure and high-temperature wash down

Glossary

10Base-T (as a transmission medium) A network running at 10 Mbps, using baseband technology and twisted pair cabling.

10Base-T (as a wiring sequence) A variation of 568A wiring, omitting the two wire pairs used for voice transmission.

100Base-F A network running at 100 Mbps, using baseband technology and fiber-optic cabling.

100Base-T A network running at 100 Mbps, using baseband technology and twisted pair cabling.

110 Punchdown Block A standard Insulation Displacement Connection (IDC) used to field terminate cable to a receptacle.

802.3 The upper level IEEE working group responsible for the standards associated with Ethernet and other CSMA/CD networks.

1000Base-T A network running at 1000 Mbps, using baseband technology and twisted pair cabling.

A

Abrasion Resistance Ability of wire, cable or material to resist surface wear.

AC (Alternating Current) Current in which the charge-flow periodically reverses and is represented by $I = I_0 \cos(2f + \theta)$. Where, I is the current, I_0 is the amplitude, f the frequency, θ the phase angle.

Active or Intelligent Device Devices that can be connected as nodes, with unique MAC IDs, to a DeviceNet™ system. These devices can provide diagnostics including troubleshooting.

Ambient Temperature The temperature of a medium (gas or liquid) surrounding an object.

American Wire Gauge (AWG) The standard system used for designating wire diameter. The lower the AWG number, the larger the diameter. Also called the Brown and Sharpe (B & S) wire gauge.

Ampere (A) The unit of current. One ampere is the current flowing through one ohm of resistance at one volt potential.

Analog Representation of data by continuously variable quantities.

Anneal To soften and relieve strains in any solid material, such as metal or glass, by heating to just below its melting point and then slowly cooling it. Annealing generally lowers the tensile strength of the material, while improving its flex life and flexibility.

ANSI American National Standards Institute.

Appliance Wiring Material (AWM) A UL designation covering insulated wire and cable for internal wiring of appliances and equipment.

Application Layer The software portion of a bus which determines the system's attributes. For DeviceNet™, defines how identifiers are assigned (controlling priorities) and how a CAN data field is used to specify services, move data and determine that data's meaning.

Arbitration (mechanism) Resolves potential network conflicts between nodes without loss of data or bandwidth. For DeviceNet™, a bit-wise, non-destructive arbitration method is used.

Armored Cable A cable provided with a wrapping of metal for mechanical protection.

ASI Actuator Sensor Interface.

ASIC Application-Specific Integrated Circuit — A semiconductor designed to perform a particular function by defining the interconnection of a set of basic building blocks drawn from a library provided by the circuit manufacturer.

Assembly Object Differing application objects grouped into a single attribute which can be moved with a single message.

ASTM Abbreviation for the American Society for Testing and Materials, a non-profit industry-wide organization which publishes standards, methods of tests, recommended practices, definitions and other related material.

Attenuation Amplitude dissipation of an electrical signal as it travels over distance, expressed in decibels.

Auto-Negotiate (Auto-Sense) Part of the 802.3u specification which details how devices at either end of a link advertise to the other their connection mode (speed and duplex that can be supported). Should both devices be equipped with Auto-Negotiate (vendor optional), they will select the highest common protocol for communication. Also referred to as Auto-Sense.

Autobaud Feature on DeviceNet™-active devices that sets their data rate to the correct value when connected to an existing network.

AWG American Wire Gauge — A standard used to define the physical size of a conductor determined by its circular mil area (1 mil = .001).

AWM see Appliance Wiring Material.

B

Baseband A communication network that transmits data over a single carrier frequency.

Baud A data transmission measurement for modems.

Baud Rate Measurement of data transfer speed (1 baud = 1 bit per second).

Binder A spirally served tape or thread used for holding assembled cable components in place awaiting subsequent manufacturing operations.

Bit A single character of a language having just two characters, as either of the binary digits 0 or 1.

Bit Bus A bus architecture that communicates the minimum amount of information possible through a bus. Does not accommodate diagnostics.

Braid A fibrous or metallic group of filaments interwoven in cylindrical form to form a covering over one or more wires.

Breakdown (Puncture) A disruptive discharge through insulation.

Breakdown Voltage The voltage at which the insulation between two conductors breaks down.

Bus A parallel circuit that connects the major components of an architecture, allowing the transfer of electric impulses from one connected component to any other.

Byte A sequence of 8 bits (enough to represent one character of alphanumeric data) processed as a single unit of information.

C

Cable A stranded conductor with or without insulation and other coverings (single-conductor cable), or a combination of conductors (multiple-conductor cable).

Cable Filler The material used in multiple-conductor cables to occupy the interstices formed by the assembly of the insulated conductors, thus forming a cable core.

Cable Sheath The protective covering applied to cables.

Cabling Twisting together two or more insulated conductors by machine to form a cable. In fiber optics, a method by which a group or bundle of fibers is mechanically assembled.

CAN Controller Area Network — An ASIC used by DeviceNet™ and Smart Distributed Systems.

Capacitance Storage of electrically separated charges between two plates (or wires). Unbalance, in the case of a data wire pair, results in the transfer of unwanted signals.

Capacitance (C) The ability of dielectric material between conductors to store electricity when a difference of potential exists between the conductors. The unit of measure is the farad, which is the capacitance value that will store a charge of one coulomb when a one-volt potential difference exists between the conductors. In AC, one farad is the capacitance value which will permit one ampere of current when the voltage across the capacitor charges at a rate of one volt per second.

Category 5/5E/6 A TIA/EIA rating system that describes the physical properties of the communication channel in relation to its performance at specific communication speeds.

CENELEC European standards agency; European Committee for Electrotechnical Norms.

Change-of-State Type of messaging where the device produces data only when there is a change.

CL2 Designation of cable which meets the vertical tray flame test for class 2 systems.

Coaxial Cable A cylindrical transmission line comprised of a conductor centered inside a metallic tube or shield, separated by a dielectric material, and usually covered by an insulating jacket.

Collision Domain The group of nodes that are attached to the network in such a way that only one of those nodes can be transmitting at any one time. Nodes connected together using repeater hubs usually belong to a single collision domain, while those attached by a switching hub are generally isolated from the collision domain.

Color Code A color system for wire or circuit identification by use of solid colors, tracers, braids, surface printing etc.

Complementary Output A solid state sensor with one N.O. and N.C. output similar to a mechanical SPDT or DPST contact.

Composite Cable A cable consisting of two or more types or sizes of wire.

Compound An insulating or jacketing material made by mixing two or more ingredients.

Conductivity The ability of a material to allow electrons to flow, measured by the current per unit voltage applied. It is the reciprocal of resistivity.

Conductor A wire (or combination of wires not insulated from one another) suitable for carrying electric current.

Conduit A tube or trough in which insulated wires and cables are run.

Connector A device used to provide rapid connect/disconnect service for electrical cable and wire terminations.

Contact The part of a connector which actually carries the electrical current, and are touched together or separated to control the flow.

Control Cable A multiconductor cable made for operation in control of signal circuits.

Copolymer A compound resulting from the polymerization of two different monomers.

Cord A small, flexible insulated cable.

Cordset Portable cord fitted with a wiring device at one or both ends.

CRC Cyclic Redundancy Code — An error correction code that is recorded in each sector of a magnetic disk and used to catch errors in data.

Creepage The conduction of electricity across the surface of a dielectric.

Creepage Surface An insulating surface which provides physical separation as a form of insulation between two electrical conductors of different potential.

Crimp Termination Connection in which a metal sleeve is secured to conductor by mechanically crimping the sleeve with pliers, presses, or automated crimping machines.

Cross-linked Inter-molecular bonds between long chain thermoplastic polymers created by means of chemical or electron bombardment. The properties of the resulting thermo-setting materials are usually improved.

CSA Abbreviation for Canadian Standards Association, a non-profit independent organization which operates a listing service for electrical and electronic materials and equipment. The Canadian counterpart of the Underwriters Laboratories.

CSMA/CD Carrier Sense Multiple Access/Collision Detect — The media access method used in Ethernet architectures. All network nodes are able to detect the presence of a signal on the channel (Carrier Sense). Once the network is clear, all nodes with something to transmit vie equally for access to the channel (Multiple Access). If a node detects another signal during its transmission, the signals collide, both nodes back-off and retry at a random amount of time later (Collision Detect).

CSPE-Chlorosulfonated Polyethylene A rubbery polymer used for insulations and jackets. Manufactured by E. I. DuPont™ under the trade name of Hypalon.

Current (I) The rate of transfer of electricity. Practical unit is the ampere which represents the transfer of one coulomb per second. In a simple circuit, current (I) produced by a cell or electromotive force (E) when there is an external resistance (R) and internal resistance (r) is $I = E / (R + r)$.

Current Carrying Capacity The maximum current an insulated conductor can safely carry without exceeding its insulation and jacket temperature limitations.

Cut-Through Resistance The ability of material to withstand mechanical pressure, usually a sharp edge or small radius, without separation.

Cyclic Option The device set-up to report its data on a regular basis, consistent with the rate of change it can detect.

D

Daisy Chain A bus wiring scheme in which, for example, device A is wired to device B, device B is wired to device C, etc. All devices may receive identical signals or, in contrast to a simple bus, each device in the chain may modify one or more signals before passing them down the line.

DC-Direct Current An electric current which flows in only one direction.

Device Object A DeviceNet product will have a single instance of a DeviceNet object. The instance will have the following attributes: node; address (MAC ID); baud rate; bus-off action; bus-off center; allocation choice; and MAC ID.

Device Profile Fully defines the device as viewed from the network. DeviceNet specifications contain such profiles.

Diagnostics Relaying of information regarding the various states or conditions of certain controls back to the PLC or PC.

Dielectric An insulating medium which intervenes between two conductors and permits electrostatic attraction and repulsion to take place across it.

Dielectric Strength The voltage which an insulation can withstand before breakdown occurs. Usually expressed as a voltage gradient (such as volts per mil).

Drain Wire In a cable, the uninsulated wire laid over the component or components and used as a ground connection.

Drop Cable Cable that exits a trunk cable and runs to a control.

E

E Symbol for voltage. Usually used to represent direct voltage or the effective (Root-mean-square) value of an alternating voltage.

Earth British terminology for zero-reference ground.

EDS (Electronic Data Sheet) An electronic version of a device's configurable parameters and public interfaces to the correct parameters.

EIA Electronic Industries Association (formerly RMA or RETMA).

Elastomer A rubber or rubber-like material which will stretch repeatedly to 200 percent or more and return rapidly and with force to its approximate original shape.

EPDM Ethylene-propylene-diene monomer rubber. A material with good electrical insulating properties.

EPR Ethylene-propylene copolymer rubber. A material with good electrical insulating properties.

Ethernet/IP™ A networking protocol which uses Ethernet for the physical and media access layer, and incorporates the CIP (Controller Information Protocol) from DeviceNet™ as the application layer.

Explicit Messages Provide a multi-purpose pt-pt commission path between two devices. These messages are typically used for low-priority identifiers and contain the specific meaning of the message right in the data field. This usually means the service to be performed, as well as the specific object attribute address, is imbedded herein.

Extruded Cable Cable with conductors which are uniformly insulated and formed by applying a homogeneous insulation material in a continuous extrusion process.

F

Fast Ethernet An Ethernet network operating at 100 Mbps.

FEP Fluorinated ethylene-propylene. A thermo-plastic material with good electrical insulating properties and chemical and heat resistance.

Fiber-Optic Cable A transmission medium using a central glass fiber which transmits digital signals, generated from a laser or LED, expressed as light pulses.

Fillers Non-conducting components cabled with the insulated conductors or optical fibers to impart roundness, flexibility, tensile strength, or a combination of all three, to the cable.

Fine Stranded Wire Stranded wire with component strands of 36 AWG or smaller.

Flexible That quality of cable or cable component which allows for bending under the influence of outside force, as opposed to limpness which is bending due to the cable's own weight.

FR-1 A flammability rating established by Underwriter's Laboratories for wires and cables that pass a specially designed vertical flame test. This designation has been replaced by VW-1.

FT1 A vertical flammability rating for wires and cable developed by CSA.

FT4 A vertical flammability rating for wires and cable developed by CSA that is more severe than FT1.

Full-Duplex Media Supports both transmission and reception of a signal at the same time. These nodes effectively double their available bandwidth.

G

Gauge A term used to denote the physical size of a wire.

Ground An electrical connection to the earth, generally through a ground rod. Also a common return to a point of zero potential, such as the metal chassis in radio equipment.

Ground Loop A completed circuit between shielded pairs of a multiple pair created by random contact between shields. An undesirable circuit condition in which interference is created by ground currents when grounds are connected at more than one point.

Ground Potential The potential of the earth. A circuit, terminal, or chassis is said to be a ground potential when it is used as a reference point for other potentials in the system.

H

Hertz (Hz) The unit of frequency, one cycle per second.

Hi-Pot A test designed to determine the highest voltage that can be applied to a conductor without breaking through the insulation.

Horizontal Cross-Connect A cabling system that extends from communications equipment to the work area outlet.

Hub The focal point in a messaging handling service, a number of local computers might exchange messages solely with a hub (or focal point) computer. Would be responsible for exchanging messages with other hubs and non-local computers.

Hygroscopic Capable of absorbing moisture from the air.

Hypalon A DuPont™ trade name for synthetic rubber (chlorosulfonated Polyethylene) used as insulating and jacketing material for wire and cable.

I

I/O Input/Output

I/O Messages Apply to time-critical, control-oriented data. They provide a dedicated, special purpose commission path between producers and consumers of data on a network.

Identity Object Typically, a single instance for each DeviceNet™ product. Attributes will be vendor ID, device type, product code, revision, status, S/N, product name and statistics.

IEC European Standardization agency; International Electrotechnical Commission.

IEC International Electro-technical Commission.

IEEE Abbreviation for Institute of Electrical and Electronics Engineers.

Impedance The apparent resistance in an electrical circuit to the flow of an alternating current, similar to the actual electrical resistance to a direct current, keeping the ratio of electromotive force to the current.

Impedance (Z) The total opposition that a circuit offers to the flow of alternating current of any other varying current at a particular frequency. It is a combination of resistance R and reactance X, measured in ohms.

Inductance (L) A property of a conductor or circuit which resists a change in current. It causes current changes to lag voltage changes and is measured in henrys.

Inductive Proximity Sensor A sensing device that is actuated by a metal object.

Input A signal (or power) which is applied to a piece of electrical apparatus or the terminals on the apparatus to which a signal or power is applied.

Insulation A material having good dielectric properties which is used to separate close electrical components, such as cable conductors and circuit components.

Interoperability The ability of two or more differing systems or controls to communicate.

IP Internet Protocol — The Network Layer, 24-bit addressing scheme used by most Ethernet networks

IR Drop The designation of a voltage drop in terms of current and resistance.

Irradiation In insulation, the exposure of the material to high energy emissions for the purpose of favorably altering the molecular structure.

ISO International Standards Organization.

J

Jacket Pertaining to wire and cable, the outer protective covering, may also provide additional insulation.

L

Leakage The placement or routing of wiring and component leads in an electrical circuit.

LED Light emitting diode used to indicate device status.

Limpness The ability of a cable to lay flat or conform to a surface as with microphone cables (also see flexibility).

Line Voltage The value of the potential existing on a supply or power line.

Litz Wire Fine stranded cable or wire.

Load A device that consumes power from a source and uses that power to perform a function.

Longitudinal Wrap Tape applied longitudinally with the axis of the core being covered.

M

MAC ID Assigned as the address of nodes on a DeviceNet network. DeviceNet uses a device address inside the CAN identifier field and it represents a mechanism for detecting duplicated addressed devices.

Master/Slave Stand-alone authorization to transmit belongs exclusively to one station (master), while other stations (slaves) transmit only upon request.

MCM One thousand circular mils.

Media Access Control Layer two of the OSI model defines the mechanisms used to determine access to the communication channel.

Message A packet of information that is delivered to and from a control comprised of bits and/or bytes.

Message Router Object An element of a component that passes explicit messages to other objects.

Microfarad One-millionths of a farad (2f or mfd are common abbreviations).

Micron millionth of a meter = 10^{-6} m.

Mil A unit used in measuring diameter of a wire or thickness of insulation over a conductor. One-one thousandth of an inch (.001").

Moisture Resistance The ability of a material to resist absorbing moisture from the air or when immersed in water.

Molded Plug A connector molded on either end of a cord or cable.

MTW Thermoplastic insulated machine tool wire. 600V rating.

Multiplex A technique for putting two or more signals into a single channel.

Mutual Capacitance Capacitance between two conductors when all other conductors are connected together.

Mylar® DuPont trademark for polyester film.

N

NAMUR Sensor A 2-wire, analog DC sensor which requires a remote amplifier for operation (Normenausschuss Arbeitskreis Mess und Regeltechnik).

NEC (National Electric Code) A set of regulations governing construction and installation of electrical wiring and apparatus in the United States, established by the American National Board of Fire Underwriters.

NEMA National Electrical Manufacturers Association.

Neoprene A synthetic rubber with good resistance to oil, chemical, and flame. Also called polychloroprene.

Network A system of computers and other devices interconnected by telephone wires or other means in order to share information.

NEXT Near End Cross Talk — The level of unwanted signal transferred from the transmitting wires to the receiving wires measured on the transmitting end. The specification is in decibels and refers to the maximum amount of signal that will be ignored, meaning the higher the decibel rating the better the specification. The same specification measured on the receiving end is referred to as Far End Cross Talk (FEXT).

NFPA Abbreviation for National Fire Protection Association. Administrative Sponsor for the National Electrical Code (ANSI Standards Committee (CI)).

Nodes Used to describe a single control or address and its supporting components.

Noise In a cable or circuit, any extraneous signal which tends to interfere with the signal normally present in or passing through the system.

NPN Output Transistor output that switches the common or negative voltage to the load (current sinking). Load connected between output and positive supply.

Nylon An abrasion-resistant thermoplastic with good chemical resistance, also known as PA.

O

Object DeviceNet™ node that is modeled via software as a collection of objects. Objects provide an abstract replication of a particular component within a product.

Object Model Provides a template for organizing and implementing attributes, services and behaviors of components of DeviceNet products.

Ohm The electrical unit of resistance. The value of resistance through which a potential difference of one volt will maintain a current of one ampere.

Ohms Law $E = U \times R$. Voltage (E) is directly proportional to the product of current (I) and resistance (R) of circuit.

Open Architecture/Network A protocol that is available to and open to the public without purchase of a licensing agreement.

Open Style Connector Approved connector style for DeviceNet where low-cost in panel connection to devices is required. It allows for the simple daisy-chaining of multiple devices.

Open Systems Interconnect (OSI) Model The International Standards Organization definition of the 7 communication layers that must be supported in a device for it to share network services with similar and dissimilar devices.

Output The useful power or signal delivered by a circuit or device.

Ozone Extremely reactive form of oxygen, normally occurring around electrical discharges and present in the atmosphere in small but active quantities. In sufficient concentrations it can break down certain rubber insulations under tension (such as a bent cable).

P

Parameter Object Used in devices with configurable parameters. One instance would be presented for each configurable parameter. The parameter object provides a standard way for a configuration tool to access all of the parameters including values, ranges, text strings and limits.

PBT Polybutylene terephthalate. A long fiber-reinforced thermoplastic with outstanding chemical resistance and dimensional stability properties.

PE (Cellular) Expanded or foam polyethylene.

Peer-to-Peer One control communicated directly with another control.

Physical Layer Layer consisting of sensors, actuators, cables and other control devices.

Picofarad One-millionth of one-millionth of a farad. A micro-microfarad or picofarad (abbreviation pf).

Plastic High polymeric substances, including both natural and synthetic products, but excluding the rubbers, that are capable of flowing under heat and pressure.

Plasticizer A chemical agent added to plastics to make them softer and more pliable.

PLC Programmable Logic Controller.

Plug The part of the two mating halves of a connector which is movable when not fastened to the other mating half.

PNP Output Transistor output that switches the positive voltage to the load (current sourcing). Load connected between output and common.

Polybutadiene A type of synthetic rubber often blended with other synthetic rubbers to improve their properties.

Polyester Polyethylene terephthalate, used extensively as a moisture resistant cable core wrap.

Polyethylene (PE) A thermoplastic material having excellent electrical properties.

Polymer A material of high molecular weight formed by the chemical union of monomers.

Polyolefin Any of the polymers and copolymers of the ethylene family of hydrocarbons.

Polypropylene A thermoplastic similar to polyethylene but stiffer and having higher softening point (temperature); excellent electrical properties.

Polyurethane (PUR) Broad class of polymers noted for good abrasion and solvent resistance. Can be in solid or cellular form.

Polyvinyl Chloride (PVC) A general purpose thermoplastic widely used for wire and cable insulations and jackets.

Potting The sealing of a cable termination or other component with a liquid which thermosets into an elastomer.

Power The amount of work per unit of time. Usually expressed in watts and equal to I2R.

PROFIBUS* DP A polling PROFIBUS* network, whereby the assigned master requests the status of each node.

PROFIBUS* FMS A PROFIBUS* network which supports both peer-to-peer and master-to-master messaging format.

PROFIBUS* PA A PROFIBUS* network that provides both data and power over the same two wires in accordance with IEC 1158-2. Typically used in intrinsically safe applications.

Protocol Language and logic utilized in software to address a control for communications between two devices or processes.

Proximity Switch A sensing device that detects the presence of an object without physical contact.

PVC Polyvinyl Chloride. A general purpose thermoplastic widely used in wire/cable jacketing.

R

Reactance (X) A measure of the combined effects of capacitance and inductance on an alternating current. The amount of such opposition varies with the frequency of the current. The reactance of a capacitor decreases with an increase in frequency; the opposite occurs with an inductor.

Real Time The immediate performance of an activity/command.

Resistance (R) A measure of the difficulty in moving electrical current through a medium when voltage is applied. It is measured in ohms.

Response Time Time necessary to receive a response or trigger an activity from PLC to the control.

Retractable Chord A cord having specially treated insulation or jacket so that it will retract like a spring. Retractability may be added to all or part of a cord's length.

RJ-11 A 4- or 6-pin modular connector used with twisted pair cable primarily in telephony applications, but also applicable in some datacom applications.

*PROFIBUS is a registered trademark of PROFIBUS and PROFINET International (PI)

RJ-45 An 8-pin modular connector used with twisted pair cable in datacom or datacom/telephony applications.

Rope Lay Conductor A conductor composed of a central core surrounded by one or more layers of helically laid groups of wires.

Round Media Two twisted pair wires (24V DC power and signal) plus drain in one cable per DeviceNet™ standards.

Rubber (Wire Insulation) A general term used to describe wire insulations made of thermosetting elastomers, such as natural or synthetic rubbers, neoprene, hypalon, buty rubber and others.

S

S Heavy duty, rubber-insulated portable cord. Stranded copper conductors with separator and individual rubber insulation. Two or more color coded conductors cabled with filler, wrapped with separator and rubber jacketed overall. 600V.

SAB Sensor/Actuator Bus — Integration of several sensors and actuators on one cable.

SAE Society of Automotive Engineers.

SBR A copolymer of styrene and butadiene. Also GR-S or Buna-S. Most commonly used type of synthetic rubber.

Sealed Style of Connector Molded quick-connect/disconnect style of connectors approved for DeviceNet™ installations which allow network devices to be simply added or replaced. Used when devices are exposed to a factory environment and reduced installation time and elimination of miswirings are critically important considerations.

Self Extinguishing The characteristic of a material whose flame is extinguished after the igniting flame is removed.

Semi-Rigid A cable containing a flexible inner core and a relatively inflexible sheathing.

Separator A layer of insulating material which is placed between a conductor and its dielectric, between a cable jacket and the components it covers, or between various components of a multiple-conductor cable.

Serve A filament or group of filaments such as fibers or wires, wound around a central core.

Sheath The outer covering or jacket of a multiconductor cable.

Shield In cables, a metallic layer placed around a conductor or group of conductors to prevent electrostatic or electromagnetic interference between the enclosed wires and external fields.

Shield A metallic layer applied over a group of wires to prevent interference between the enclosed wires and external fields or noise.

Shield Percentage The physical area of a circuit or cable actually covered by shielding material expressed as a percentage.

Signal Any visible or audible indication which can convey information. Also, the information conveyed through a communication system.

Silicone General Electric trademark for a material made from silicone and oxygen. Can be in thermosetting elastomer or liquid form. The thermosetting elastomer form is noted for high heat resistance.

SJ Junior hard service, rubber insulated pendant or portable cord. Same construction as type S, but 300V. Jacket thickness differs.

SJO Same as SJ, but Neoprene, oil-resistant compound outer jacket. Can also be made "water-resistant." 300V, 60° C.

SJT Junior hard service thermoplastic or rubber insulate conductors with overall plastic jacket. 300V, 60° C.

SJTO Same as SJT but oil-resistant plastic outer jacket. 60° C.

Smart Sensors Sensors that have an ASIC embedded directly in/on the control.

SO Hard service cord, same construction as type S except oil-resistant rubber jacket. 600V, 60 to 90° C.

Solid Conductor A conductor consisting of a single wire.

Solid State Pertains to circuits and components using semiconductors without moving parts. Example transistors, diodes, SCR, etc.

SOOW Same as SOW but with oil-resistant rubber conductor insulation and suitable for outdoor use.

SOW Rubber-jacketed portable cord with oil- and water-resistant outer jacket.

ST Hard service cord, jacketed, same as Type S except all plastic construction 600V, 60 to 105° C.

Star Topology A communication network based upon individual nodes connected to a central hub device that receives and directs all transmissions. (See Topology).

STOOW Same as ST but with oil- and water-resistant, outdoor rated thermoplastic outer jacket and insulation. 600V.

STP Shielded Twisted Pair — a wire used in certain SAB applications.

Stranded Conductor A conductor composed of groups of wires twisted together.

SV Vacuum cleaner cord, two or three conductor, rubber insulated. Overall rubber jacket. For light duty in damp locations. 300V, 60° C.

SVO Same as SV except Neoprene jacket 300V, 60° C.

SVT Same as SV except all plastic construction. With or without third conductor for grounding purposes only. 300V, 60 to 90° C.

SVTO Same as SVT except with oil-resistant jacket. 60° C.

Switching Hub A device that interconnects network segments at the data link layer.

T

Teflon® DuPont™ Company trade name for fluorocarbon resins. FEB, PFA and TFE are typical materials.

Tefzel DuPont trade name for a fluorocarbon material typically used as a wire wrap insulation.

Temperature Rating The maximum temperature at which an insulating material may be used in continuous operation without loss of its basic properties.

TEW Canadian Standard Association type appliance wires. Solid or stranded single conductor, plastic-insulated. 600V, 105° C TFE Teflon® (tetrafluoroethylene).

Thermal Rating The temperature range in which a material will perform its function without undue degradation.

Thermoplastic A material which will soften, flow, or distort appreciably when subjected to heat and pressure.

Thermoset A material which hardens or sets when heat is applied, and which, once set, cannot be resoftened by heating. The application of heat is called "curing."

THHN 90° C, 600V nylon jacketed building wire.

THW Thermoplastic vinyl insulated building wire. Flame retardant, moisture and heat resistant. 75° C. Dry and wet locations.

THWN Same as THW but with nylon jacket over. 75° C.

TIA 568A/B Standard 8-pin wiring sequences which defines the position of the individual transmit and receive pairs and the color code used for each wire.

TIA/EIA Telecommunications Industry Association/Electronic Industry Association — A standards organization which sets guidelines for structured cabling systems used in commercial premises.

Tinsel A type of electrical conductor comprised of a number of tiny threads, each thread having a fine, flat ribbon of copper or other metal closely spiraled about it. Used for small size cables requiring limpness and extra-long flex life.

Topology The arrangement in which the nodes of a LAN are connected to each other.

TPE Thermoplastic elastomer. A thermoplastic compound with exceptional chemical, oil, and weld slag resistance used as a jacket material in multiconductor cables.

Transceiver The component in the node that is responsible for the interface to the network.

Trunk Cable Also known as Bus Cable, it is the main or power and communications cable.

TW Thermoplastic vinyl-jacketed building wire, moisture-resistant. 60° C.

Twisted Pairs A cable composed of two small insulated conductors twisted together without a common covering.

U

UL Underwriters Laboratories.

UTP Unshielded Twisted Pair — Wire used in certain SAB applications.

V

VA Volt-Ampere. A designation of power in terms of voltage and current.

VDE German approval agency.

VDR Voltage Dependent Resistor. A surge suppression circuit type where the resistance varies inversely with the applied voltage.

Velocity of Propagation A function of the dielectric constant, expressed as a percent of transmission speed of a signal down the wire as compared to free space.

Volt (V) A unit of electrical pressure. One volt is the electrical pressure that will cause one ampere of current to flow through one ohm of resistance.

Voltage The term most often used in place of electromotive force, potential difference, or voltage drop to designate the electric pressure that exists between two points and is capable of producing a current when a closed circuit is connected between two points.

Voltage Drop The voltage developed across a component or conductor by the current flow through the resistance or impedance of the component or conductor.

Voltage Rating The highest voltage that may be continuously applied to a wire in conformance with standards or specifications.

VW-1 A flammability rating established by Underwriters Laboratories for wires and cables that pass a specially designed vertical flame test, formerly designated FR-1.

W

Watt (W) A unit of electrical power. One watt is equivalent to the power represented by one ampere of current with a pressure of one volt in a DC circuit.

Weld Field Immune Devices carrying this designation will not false trigger in the presence of extreme electromagnetic fields produced by resistance welders.

Wicking The longitudinal flow of a liquid in a wire or cable due to capillary action.

X

XLPE Crosslinked polyethylene.

Series No. Index

<i>Series No.</i>	<i>Page</i>	<i>Series No.</i>	<i>Page</i>	<i>Series No.</i>	<i>Page</i>	<i>Series No.</i>	<i>Page</i>
112000	292, 336, 337, 381	120028	128	120113	76-78, 132-134	130035	152, 218, 250-253, 266, 282
112005	228	120031	73, 129, 130	120114	54-61, 116-123	130036	254, 255
112008	227	120039	265, 304, 305	120119	29-36, 91-98	130037	267, 268
112011	292-295	120054	78, 134	120149	129	130038	277
112013	290, 291	120055	32, 55, 57-59, 94, 118, 119, 120, 121	120155	185	130039	219, 234-237, 244, 245, 249, 252, 253, 255, 259-261, 265, 266, 269-271, 281
112014	297	120065	38-41, 100-105, 107, 283, 323 325	120230	31, 55, 93, 118, 174, 175	130047	364
112016	298, 299	120066	42-45, 104-107, 284, 324, 326	120231	176-179	130048	346, 360-363, 366
112018	296	120067	46-48, 108-110	120233	181, 182	130050	344-348
112019	378	120068	52, 53, 114, 115	120234	183, 184	130053	349, 350
112020	381	120070	49, 50, 111, 112, 263, 285, 327, 328	120244	372	130054	369, 371
112021	380	120071	51, 113, 286, 329	120341	373, 374	130055	351, 352
112023	379	120072	62, 63	120355	372	130057	354
112026	290, 300	120073	64, 65	121012	188, 191, 192	130058	353, 354
112027	230, 334, 335, 382	120074	66, 67	121040	193, 194, 196, 197	130060	154-157
112028	291, 294	120075	68	121201	188	130061	212, 213
112029	384	120077	20, 21, 24, 82, 83, 86, 283, 323, 325	121202	189	130062	214
112030	230, 291, 294, 297	120079	22, 23, 28, 84, 85, 90, 284, 324, 326	121203	190	130063	205, 206
112034	226, 292	120082	90	121204	191	130064	207
112035	290	120083	24, 86	121205	192	130066	210, 215
112036	343	120084	25, 26, 87, 88, 285, 327, 328	130006	138-141, 151, 154, 156	130068	208, 209
112038	301, 302	120085	27, 89, 286, 329	130007	154, 155, 158, 159	130070	211, 217
112073	338	120086	70, 71, 126, 127	130008	29, 30, 54, 56, 91, 92, 116, 117, 154, 155, 164, 165, 169	130188	246
112076	229	120087	72, 128	130010	142, 143, 157, 218, 278, 319	130201	153, 217, 163, 171
112078	378	120088	79, 135	130011	160	130211	303
112079	379	120089	78	130012	166, 169	84586	392, 393
112086	380	120090	73, 74	130013	144-149, 219, 247, 279, 320	84695	386
112092	232, 233	120091	75, 131	130014	161, 162	84700	358, 359, 407
112095	339, 340	120094	31, 32, 55, 57, 93, 94, 118, 119, 180	130015	167, 168, 170	84702	355-358
112098	383	120098	304-306, 314-318	130017	150, 216, 280, 321	84727	404
112105	342	120099	307-309	130018	151-153, 218	84728	405
112106	332-334	120100	310, 313	130023	76, 132	84729	405, 406
112111	342	120101	152, 312, 322	130024	238-241	84730	406
112113	228	120102	311	130025	240, 242, 243	84732	404
112115	231, 341	120103	313	130027	256, 257	84854	386-389, 391, 392, 402
112116	231, 341	120108	360, 361, 363, 365, 370	130028	258	84856	396-402
112117	231, 341	120109	367, 368, 370	130029	272, 273	84859	395
120006	100, 102, 104, 108, 325			130030	274-276	84863	394
120007	104, 106, 326			130031	261, 262	84864	390
120009	115			130033	271	860000	332, 333
120011	49, 50, 111, 112			130034	248, 264		
120020	83						
120025	88						
120027	126, 127						

Order No. Index

<i>Order No.</i>	<i>Engineering No.</i>	<i>Page</i>	<i>Order No.</i>	<i>Engineering No.</i>	<i>Page</i>	<i>Order No.</i>	<i>Engineering No.</i>	<i>Page</i>
84586-0017	006.....	393	84854-6039	060.....	389	84856-9110	003.....	398
84586-0018	007.....	392	84854-6041	061.....	389	84856-9111	004.....	398
84586-0019	008.....	392	84854-6042	062.....	389	84856-9112	110.....	400
84695-9095	009.....	386	84854-6043	063.....	389	84856-9113	111.....	401
84700-0001	010.....	358	84854-6044	064.....	389	84856-9114	112.....	401
84700-0002	011.....	359	84854-6055	065.....	389	84856-9115	113.....	401
84700-0003	012.....	359	84854-7021	066.....	387	84859-9001	114.....	395
84700-0003	013.....	407	84854-7022	067.....	387	84859-9002	115.....	395
84702-0005	014.....	358	84854-7023	068.....	387	84859-9003	116.....	395
84702-0006	015.....	358	84854-7024	069.....	387	84859-9004	117.....	395
84702-0007	016.....	358	84854-7025	070.....	387	84863-9001	118.....	394
84702-0008	017.....	358	84854-7026	071.....	387	84863-9002	119.....	394
84702-0009	018.....	358	84854-7027	072.....	387	84863-9003	120.....	394
84702-1003	019.....	356	84854-7028	073.....	387	84864-9001	121.....	390
84702-1006	020.....	356	84854-7029	074.....	387	84864-9002	122.....	390
84702-1010	021.....	356	84854-7030	075.....	387	84864-9003	123.....	390
84702-1020	022.....	356	84854-7031	076.....	387	84864-9004	124.....	390
84702-2003	023.....	357	84854-8021	077.....	388	84864-9005	125.....	390
84702-2007	024.....	357	84854-8022	078.....	388	84864-9006	126.....	390
84702-2010	025.....	357	84854-8023	079.....	388	112000-0001	APP-EPB-PCU-C	292, 336
84702-2012	026.....	357	84854-8024	080.....	388	112000-0003	APP-ESR-PCU-C	336, 381
84702-2015	027.....	357	84854-8025	081.....	388	112000-0005	APP-ETH-PCU-C	336
84702-2020	028.....	357	84854-8026	082.....	388	112000-5026	APP-ETH-PCIE	336
84702-2021	029.....	357	84854-8027	083.....	388	112000-5027	APP-ESR-PCIE	336, 381
84702-3020	030.....	355	84854-8028	084.....	388	112000-5028	APP-EPB-PCIE	292, 336
84727-1001	031.....	404	84854-8029	085.....	388	112000-5029	DRL-EMB-PCU	337
84727-1002	032.....	404	84854-8030	086.....	388	112000-5030	DRL-EIP-PCU	337
84727-1003	033.....	404	84854-8031	087.....	388	112000-5031	DRL-EPN-PCU	337
84727-1004	034.....	404	84854-9019	088.....	402	112000-5032	DRL-EPN-PCIE	337
84727-1005	035.....	404	84854-9300	089.....	402	112000-5033	DRL-EIP-PCIE	337
84728-1001	036.....	405	84854-9316	090.....	386	112000-5034	DRL-EMB-PCIE	337
84728-1002	037.....	405	84854-9317	848549317	391	112005-0040	SST-DN4-104-1	228
84728-1003	038.....	405	84854-9318	848549318	391	112005-0048	SST-DN4-104-2	228
84728-1004	039.....	405	84854-9319	091.....	392	112008-0003	DN-MTR-BAG	227
84728-1005	040.....	405	84856-1200	092.....	396	112008-0004	DN-MTR-CAL	227
84729-0001	041.....	406	84856-1201	093.....	396	112008-0008	SST-ENM-DN1	227
84729-0003	042.....	405	84856-1202	094.....	396	112008-0011	SST-NAS-DN1	227
84729-0004	043.....	405	84856-1203	095.....	396	112008-0012	SST-ENM-SKT	227
84729-0005	044.....	405	84856-1204	096.....	396	112008-0013	DN-MTR (E)	227
84729-0006	045.....	405	84856-1205	097.....	396	112008-0014	DN-MTR-KIT (E)	227
84729-0007	046.....	405	84856-1206	098.....	396	112008-0016	SST-ENM-PTU	227
84729-0008	047.....	405	84856-1207	099.....	396	112011-0004	APP-PFB-PCU-C	292
84729-0009	048.....	406	84856-1208	100.....	396	112011-0006	APP-PS7-PCU-C	292
84730-0010	049.....	406	84856-1209	101.....	396	112011-0008	DRL-DPM-PCU	293
84732-0001	050.....	404	84856-1210	102.....	396	112011-0021	SST-PB3-PCU	294
84732-0002	051.....	404	84856-9101	103.....	397	112011-0022	SST-PB3-PCU-2	294
84732-0003	052.....	404	84856-9102	104.....	397	112011-0024	SST-PB3-PCU-B25	294
84732-0004	053.....	404	84856-9103	105.....	402	112011-0025	SST-PBMS-PCI	295
84732-0005	054.....	404	84856-9104	106.....	399	112011-0027	SST-PB3-PCU-2-B	294
84854-6034	055.....	389	84856-9105	107.....	399	112011-0031	SST-PB3-PCIE-1	294
84854-6035	056.....	389	84856-9106	108.....	402	112011-0032	SST-PB3-PCIE-2	294
84854-6036	057.....	389	84856-9107	109.....	402	112011-5026	APP-PFB-PCIE	292
84854-6037	058.....	389	84856-9108	001.....	398	112011-5027	APP-PS7-PCIE	292
84854-6038	059.....	389	84856-9109	002.....	398	112011-5028	DRL-DPM-PCIE	293

Order No. Index

<i>Order No.</i>	<i>Engineering No.</i>	<i>Page</i>	<i>Order No.</i>	<i>Engineering No.</i>	<i>Page</i>	<i>Order No.</i>	<i>Engineering No.</i>	<i>Page</i>
112013-0003	DRL-DPM-104	290	112036-0049	DRL-332M-SSC	343	112095-0006	TCDEM-8C2P-D1U	339
112013-0013	SST-PB3-104	291	112036-0050	DRL-332M-SST	343	112095-0007	TCDEM-8DON-D1U	339
112013-0015	SST-PB3-104-B25	291	112036-0051	DRL-362M-MSC	343	112095-0008	TCDEM-8DOP-D1U	339
112014-0004	SST-PB3-VME-1	297	112036-0052	DRL-362M-MST	343	112095-0009	TCDEM-8YXX-D1U	339
112014-0006	SST-PB3-VME-2	297	112036-0053	DRL-362M-SSC	343	112095-5003	TCDEI-8DON-D1U	340
112016-0018	SST-PB3-CLX-RLL	299	112036-0054	DRL-3HOM-1MLC	343	112095-5004	TCDEI-8C2N-D1U	340
112016-0022	SST-PB3-SLC	298	112036-0055	DRL-3HOM-1SLC	343	112095-5005	TCDEI-8B4N-D1U	340
112016-0023	SST-PB3-CLX-RLL-CC	299	112036-0056	DRL-3HOM-2MLC	343	112095-5006	TCDEI-888N-D1U	340
112018-5004	DRL-DPM-CPI	296	112036-0057	DRL-3HOM-2SLC	343	112095-5007	TCDEI-8DOP-D1U	340
112019-0004	SST-ASI-SLC	378	112036-0058	DRL-362M-SST	343	112095-5008	TCDEI-8C2P-D1U	340
112020-5017	APP-SR1-PCU-C	381	112038-0003	TBDPB-408P-B8U	302	112095-5009	TCDEI-8B4P-D1U	340
112020-5018	APP-SR1-PCIE	381	112038-0005	TBDPB-444N-B8U	302	112095-5010	TCDEI-888P-D1U	340
112021-0014	DRL-CNO-PCU	380	112038-0006	TBDPB-444P-B8U	302	112095-5011	TCDEI-8YXX-D1U	340
112023-0007	DRL-CNO-104	379	112038-0007	TBDPB-462N-B8U	302	112095-5012	TCDEI-8DON-DYU	340
112023-5001	DRL-CNO-104-B25	379	112038-0008	TBDPB-462P-B8U	302	112095-5013	TCDEI-8C2N-DYU	340
112026-0013	DRL-DPS-SRM	300	112038-0009	TBDPB-480N-B8U	302	112095-5014	TCDEI-8B4N-DYU	340
112026-0014	DRL-PFB-USB	290	112038-0011	TBDPB-480P-B8U	302	112095-5015	TCDEI-888N-DYU	340
112026-0015	DRL-PFB-USB-DLL	290	112038-0014	TBDPB-808P-B84	302	112095-5016	TCDEI-8DOP-DYU	340
112027-0002	DRL-ALL-SWF-S	335, 382	112038-0015	TBDPB-844N-B84	302	112095-5017	TCDEI-8C2P-DYU	340
112027-0003	DRL-ALL-SWF-U	335, 382	112038-0016	TBDPB-844P-B84	302	112095-5018	TCDEI-8B4P-DYU	340
112027-0005	DRL-ALL-SWL-S	335, 382	112038-0017	TBDPB-862N-B84	302	112095-5019	TCDEI-888P-DYU	340
112027-0006	DRL-ALL-SWL-U	335, 382	112038-0018	TBDPB-862P-B84	302	112095-5020	TCDEI-8YXX-DYU	340
112027-0010	DRL-UPG-SWF	335, 382	112038-0019	TBDPB-880N-B84	302	112095-5021	TCDEM-8DON-DYU	339
112027-0014	SST-DN3-OPC	230	112038-0021	TBDPB-880P-B84	302	112095-5022	TCDEM-8C2N-DYU	339
112027-5007	DRL-EPN-SWF-S	334	112038-0024	TCDPB-888N-B1U	301	112095-5023	TCDEM-8B4N-DYU	339
112027-5014	DRL-SIE-SWF-S	335, 382	112038-0025	TCDPB-888P-B1U	301	112095-5024	TCDEM-888N-DYU	339
112027-5015	DRL-SIE-SWF-U	335, 382	112038-0026	TCDPB-8B4N-B1U	301	112095-5025	TCDEM-8DOP-DYU	339
112028-0030	SST-PB3-OPC	291, 294	112038-0027	TCDPB-8B4P-B1U	301	112095-5026	TCDEM-8C2P-DYU	339
112029-0008	PICS-PRO-AB	384	112038-0028	TCDPB-8C2N-B1U	301	112095-5027	TCDEM-8B4P-DYU	339
112029-0011	PICS-PRO-OPC	384	112038-0029	TCDPB-8C2P-B1U	301	112095-5028	TCDEM-888P-DYU	339
112029-0012	PICS-PRO-PBMS	384	112038-0030	TCDPB-8DON-B1U	301	112095-5029	TCDEP-8DON-D1U	340
112029-0027	SST-PICS-PRO-U	384	112038-0031	TCDPB-8DOP-B1U	301	112095-5033	TCDEP-8DOP-D1U	340
112030-0007	SST-DN3-CNF-U	230	112073-0001	SST-ESR2-CLX-RLL	338	112095-5034	TCDEP-8C2P-D1U	340
112030-0008	SST-PB3-CNF-P	291, 294, 297	112076-0001	SST-DN4-USB	229	112095-5037	TCDEP-8YXX-D1U	340
112030-0009	SST-PB3-CNF-U	291, 294, 297	112076-0002	SST-DN4-USB-SM	229	112095-5038	TCDEM-8YXX-DYU	339
112034-0018	DRL-MPI-PCU	292	112078-0001	SST-SR4-CLX-RLL	378	112098-5001	TBDCO-808P-804	383
112034-0021	SST-EDN-1	226	112079-7001	SST-CCS-PCU-B50	379	112098-5002	TBDCO-844N-804	383
112034-0026	SST-EDN-1-C2	226	112079-7002	SST-CCS-PCU	379	112098-5003	TBDCO-844P-804	383
112035-0001	DRL-MPI-USB	290	112086-5018	DRL-CNO-PCIE	380	112098-5004	TBDCO-862N-804	383
112035-0002	DRL-MPI-USB-DLL	290	112092-0006	TBDDN-444P-88U	233	112098-5005	TBDCO-862P-804	383
112036-0035	DRL-250P	343	112092-0007	TBDDN-480P-80U	233	112098-5006	TBDCO-880N-804	383
112036-0036	DRL-250M	343	112092-0008	TBDDN-880P-804	233	112098-5007	TBDCO-880P-804	383
112036-0037	DRL-280P	343	112092-0009	TCDDN-888P-11U	232	112098-5008	TBDCO-8YXX-804	383
112036-0038	DRL-280M	343	112092-0010	TCDDN-8DOP-10U	232	112105-5002	DRL-780	342
112036-0039	DRL-350M	343	112092-0018	TBDDN-480N-80U	233	112105-5004	DRL-781	342
112036-0040	DRL-380M	343	112092-0019	TCDDN-8DON-10U	232	112106-0000	SDK-EIP-ADP	333
112036-0041	DRL-3FOM	343	112092-0020	TCDDN-888N-11U	232	112106-5000	SDK-EIP-ADP-UPD	333
112036-0042	DRL-3HOM	343	112092-0022	TBDDN-880N-804	233	112106-5001	SDK-PFN-DEV	332
112036-0043	DRL-241P-MSC	343	112092-5004	TBDDN-444N-88U	233	112106-5002	SDK-PFN-DEV-UPD	332
112036-0044	DRL-241P-MST	343	112095-0001	TCDEM-888N-D1U	339	112106-5003	SDK-EIP-SCA	333
112036-0045	DRL-281P-MSC	343	112095-0002	TCDEM-888P-D1U	339	112106-5004	SDK-EIP-SCA-UPD	333
112036-0046	DRL-281P-MST	343	112095-0003	TCDEM-8B4N-D1U	339	112106-5005	SDK-PFN-CON	332
112036-0047	DRL-332M-MSC	343	112095-0004	TCDEM-8B4P-D1U	339	112106-5006	SDK-PFN-CON-UPD	332
112036-0048	DRL-332M-MST	343	112095-0005	TCDEM-8C2N-D1U	339	112106-5007	SDK-PFN-MRP	332

Order No. Index

<i>Order No.</i>	<i>Engineering No.</i>	<i>Page</i>	<i>Order No.</i>	<i>Engineering No.</i>	<i>Page</i>	<i>Order No.</i>	<i>Engineering No.</i>	<i>Page</i>
112106-5008	SDK-EIP-EML	334	120007-1271	885032E03M010	106	120065-0200	803006A09M020	40
112106-5011	SDK-EIP-CON-CNF-U	333	120007-1407	884032P03M010	106	120065-0255	804000A09M020	38
112106-5012	SDK-PFN-CON-CNF-U	332	120007-1523	884033P03M010	106	120065-0414	804006A09M020	40
112111-5001	DRL-750	342	120007-2879	883032H09M010	106	120065-0471	805000A09M020	38, 283, 323
112113-0001	SST-DN4-PCU-H	228	120009-0091	884A30P03M003	115	120065-0523	805006A09M020	40
112113-0005	SST-DN4-PCU-2	228	120011-0019	8R4J26E03C3003	112	120065-0951	808000P02M020	39, 101
112113-0007	SST-DN4-PCU	228	120011-0036	8R5J26E03C3003	112	120065-0960	808001P02M020	39, 101
112113-0009	SST-DNMS4-PCU	228	120011-0237	8R4J400013	49, 111	120065-0964	808006P02M020	41, 103
112113-0010	SST-DNMS4-PCU-H	228	120011-0238	8R5J400013	49, 111	120065-1108	803000K05M020	38, 100
112115-0001	SDK-DNS-SAF	231, 341	120011-0281	8R4J460003	50, 112	120065-1114	803006K05M020	40, 102
112115-0002	SDK-DNS-SAF-O	231, 341	120020-0002	W03007P03M020	83	120065-1121	804000K05M020	38, 100
112115-0003	SDK-DEP-SAP-SAF	231, 341	120025-0007	WR5U26E03C3003	88	120065-1129	804006K05M020	40, 102
112115-0004	SDK-DEP-SAP-SAF-O	231, 341	120027-0066	403000E02M020	126	120065-1367	805000K03M020	283, 323, 325
112115-0005	SDK-CIP-EDS-SAF	231, 341	120027-0090	403001E02M020	126	120065-1444	803001A09M020	38
112116-0001	SDK-DNS-SAF-L	231, 341	120027-0106	403007E02M020	127	120065-1489	803001K05M020	38, 100
112116-0002	SDK-EIP-ADP-SAF-L	231, 341	120027-0115	4030P1E02M020	126	120065-1497	803007A09M020	40
112117-0001	SDK-EIP-ADP-SAF	231, 341	120027-0127	404000E02M020	126	120065-1501	803007K05M020	40, 102
112117-0002	SDK-EIP-ADP-SAF-O	231, 341	120027-0152	404001E02M020	126	120065-1551	804001A09M020	38
120006-0001	803000E03M020	100	120027-0483	404007E02M020	127	120065-1639	804001K05M020	38, 100
120006-0004	803000P03M020	100	120027-0709	405000P02M020	126	120065-1662	804007A09M020	40
120006-0007	803001E03M020	100	120027-0752	405006P02M020	127	120065-1691	804007K05M020	40, 102
120006-0011	803001P03M020	100	120027-0911	403006P02M020	127	120065-1697	805001A09M020	38, 283, 323
120006-0014	804000E03M020	100	120028-0016	443031E02M010	128	120065-1720	805001K03M020	283, 323, 325
120006-0018	804000P03M020	100	120031-0004	4R3F06E02C3003	130	120065-1724	805007A09M020	40
120006-0021	804001E03M020	100	120031-0006	4R4F06E02C3003	130	120065-1800	808007P02M020	41, 103
120006-0024	804001P03M020	100	120031-0015	4R3F30E02C3003	129	120065-5040	80C000H45M020	39, 101
120006-0056	884031P03M010	104	120031-0022	4R4H40E02C3003	73, 129	120065-5045	80C006H45M020	41, 103
120006-0240	803006E03M020	102	120031-0027	4R5F06E02C3003	130	120065-5099	80C001H45M020	39, 101
120006-0257	803006P03M020	102	120031-0028	4R5F30E02C3003	129	120065-5109	80C007H45M020	41, 103
120006-0273	803007E03M020	102	120031-0046	4R3H40E02C3003	73, 129	120065-8096	805007E03M020	102
120006-0288	803007P03M020	102	120031-0049	4R4F30E02C3003	129	120065-8172	805000H09M020	100
120006-0560	804006E03M020	102	120031-0050	4R5H40E02C3003	73, 129	120065-8175	803000H09M020	100
120006-0570	804006P03M020	102	120031-0118	4R4H400013	73	120065-8178	804000H09M020	100
120006-0592	804007P03M020	102	120039-0001	DND100L	265	120065-8296	805001H09M020	100
120006-0618	8040P1P03M020	108	120039-0003	DND150L	265	120065-8513	804001H09M020	100
120006-0634	805000E03M020	100, 325	120039-0132	805501PP4M010	304	120065-8644	808000H08M020	101
120006-0647	805000P03M020	100	120039-0158	805507PP4M010	305	120065-8649	808001H08M020	101
120006-0652	805001E03M020	100, 325	120054-0004	BNY803P-FBP-05	78, 134	120065-8655	803006H09M020	102
120006-0663	805001P03M020	100	120054-0034	BEY403P-FBP-05	78, 134	120065-8660	808006H08M020	103
120006-0667	805006E03M020	102	120054-0043	BEY603P-FBP-05	78, 134	120065-8715	803001H09M020	100
120006-0680	805006P03M020	102	120054-0044	BNY603P-FBP-05	78, 134	120065-8722	803007H09M020	102
120006-0697	805007P03M020	102	120054-0045	BEYA03P-FBP-05	78, 134	120065-8729	804006H09M020	102
120006-1975	804007E03M020	102	120054-0046	BNYA03P-FBP-05	78, 134	120065-8736	804007H09M020	102
120007-0083	883030E03M010	104	120055-0308	BTY4010-FBC	55, 118	120065-8743	805006H09M020	102
120007-0119	883031E03M010	104	120055-0313	BTY4030-FBC	57, 119	120065-8750	805007H09M020	102
120007-0142	883031P03M010	104	120055-0321	BTY8010-FBC	55, 118	120065-8757	808007H08M020	103
120007-0160	883032E03M010	106	120055-0328	BTY8030-FBC	57, 119	120065-8763	883031H09M010	104
120007-0172	883032P03M010	106	120055-0583	BTY8000-FBP-05	59, 121	120065-8908	888033H08M010	107
120007-0216	883033P03M010	106	120055-0586	BTY4000-FBP-05	59	120065-8909	888031H08M010	105
120007-0473	884030E03M010	104	120055-0669	BTY403N-FBA	58, 120	120066-0166	883030A09M010	42
120007-0488	884030P03M010	104	120055-0670	BTY603N-FBA	58, 120	120066-0222	883031K05M010	42, 104
120007-0509	884031E03M010	104	120055-0672	BTY803N-FBA	58	120066-0231	883032K05M010	44, 106
120007-0554	884033E03M010	106	120055-0925	BKY8030-FBC	32, 94	120066-0266	884030A09M010	42
120007-0906	885030E03M010	104, 326	120065-0129	803000A09M020	38	120066-0376	884031K05M010	42, 104

Order No. Index

<i>Order No.</i>	<i>Engineering No.</i>	<i>Page</i>	<i>Order No.</i>	<i>Engineering No.</i>	<i>Page</i>	<i>Order No.</i>	<i>Engineering No.</i>	<i>Page</i>
120066-0400	884032K05M010	44, 106	120067-0079	8830P9K05M010	48, 110	120067-8328	8030P0H09M020	108
120066-0427	885030A09M010	42, 284, 324	120067-0095	8840P6A09M010	47	120067-8329	8830P9H09M010	110
120066-0479	888033P02M010	45, 107	120067-0101	8840P6K05M010	47, 109	120067-8330	8840P9H09M010	110
120066-0498	883030P03M010	104	120067-0107	8840P7A09M010	47	120067-8331	8830P6H09M010	109
120066-0579	888030P02M010	43, 105	120067-0112	8840P7B03M010	47	120067-8332	8840P7H09M010	109
120066-0676	883030K05M010	42, 104	120067-0117	8840P7K05M010	47, 109	120067-8333	8840P6H09M010	109
120066-0687	884030K05M010	42, 104	120067-0122	8840P8K05M010	48, 110	120067-8334	8830P8H09M010	110
120066-1034	885030K03M010	284, 324, 326	120067-0185	8030P0A09M020	46	120067-8335	8840P8H09M010	110
120066-1137	883031A09M010	42	120067-0192	8030P0B03M020	46	120068-0137	0812-05EMF-00001	52, 114
120066-1177	883032A09M010	44	120067-0198	8030P1K05M020	46, 108	120068-0139	0812-05EMF-00000	52, 114
120066-1199	883033A09M010	44	120067-0227	8030P1A09M020	46	120068-0169	81590R	52, 114
120066-1223	883033K05M010	44, 106	120067-0241	8030P1B03M020	46	120068-0170	81594R	52, 114
120066-1262	884031A09M010	42	120067-0257	8040P1A09M020	46	120068-0175	884A30A09M003	53
120066-1307	884032A09M010	44	120067-5008	8030P0P03M020	108	120068-0195	884A30K05M003	53, 115
120066-1336	884033A09M010	44	120067-5014	8040P1E03M020	108	120068-0199	884A31A09M003	53
120066-1382	884033K05M010	44, 106	120067-5040	8840P7P03M010	109	120068-0211	884A31K05M003	53, 115
120066-1389	885031A09M010	42	120067-5063	8040P0P03M020	108	120068-5031	884A31E03M003	115
120066-1399	885032A09M010	44	120067-5067	8030P1E03M020	108	120068-5035	884AP0	52, 114
120066-1421	885033K03M010	284, 324	120067-5069	8030P1P03M020	108	120068-8009	0812-051FJ-00000	52, 114
120066-1626	888031P02M010	43, 105	120067-5078	8830P7P03M010	109	120068-8096	884A30E03M003	115
120066-1634	885033A09M010	44, 284, 324	120067-5088	8830P9E03M010	110	120068-8137	884A31H09M003	115
120066-5399	883033E03M010	106	120067-5090	8840P7E03M010	109	120068-8138	884A30H09M003	115
120066-5401	885032P03M010	106	120067-5094	8040P0E03M020	108	120070-0056	8R3A00A18A120	49
120066-5402	885033E03M010	106, 326	120067-5227	8030P0E03M020	108	120070-0093	8R3006A18A120	50
120066-5403	888032P02M010	45, 107	120067-5228	8030P0K05M020	46, 108	120070-0114	8R4A00A18A120	49
120066-5404	88C030H45M010	43, 105	120067-5229	8040P0B03M020	46	120070-0173	8R4000A18A120	49
120066-5405	88C031H45M010	43, 105	120067-5230	8040P0K05M020	46, 108	120070-0184	8R4006A18A120	50
120066-5406	88C032H45M010	45, 107	120067-5231	8040P1B03M020	46	120070-0201	8R5A00A18A120	49, 285, 327
120066-5407	88C033H45M010	45, 107	120067-5232	8040P1K05M020	46, 108	120070-0235	8R5J460003	50, 112
120066-8073	884032E03M010	106	120067-5233	8830P6B03M010	47	120070-0237	8R5L30	263, 285, 327, 328
120066-8084	885030P03M010	104	120067-5235	8830P8A09M010	48	120070-0252	8R5006A18A120	50
120066-8094	885033P03M010	106	120067-5236	8830P8B03M010	48	120070-5180	8R8J460003	50, 112
120066-8188	885031P03M010	104	120067-5237	8830P8E03M010	110	120070-5200	8R3000A18A120	49
120066-8189	885031E03M010	104	120067-5238	8830P8P03M010	110	120070-5201	8R3J20E03C3003	111
120066-8374	883030H09M010	104	120067-5239	8830P9B03M010	48	120070-5202	8R3J26E03C3003	112
120066-8379	884030H09M010	104	120067-5240	8840P6B03M010	47	120070-5203	8R3J400013	49, 111
120066-8484	884031H09M010	104	120067-5241	8840P6E03M010	109	120070-5204	8R3J460003	50, 112
120066-8491	888030H08M010	105	120067-5242	8840P8A09M010	48	120070-5205	8R4J20E03C3003	111
120066-8492	884033H09M010	106	120067-5243	8840P8B03M010	48	120070-5206	8R5000A18A120	49
120066-8493	885032H09M010	106	120067-5244	8840P8E03M010	110	120070-5207	8R5J20E03C3003	111, 328
120066-8494	884032H09M010	106	120067-5245	8840P8P03M010	110	120070-5208	8R8J20E02C3003	49, 111
120066-8495	888032H08M010	107	120067-5246	8840P9A09M010	48	120070-5209	8R8J26E02C3003	50, 112
120066-8496	885031H09M010	104	120067-5247	8840P9B03M010	48	120070-5210	8R8J400013	49, 111
120066-8497	885030H09M010	104	120067-5248	8840P9E03M010	110	120071-0035	8A4000-31	51, 113
120066-8498	883033H09M010	106	120067-5249	8840P9K05M010	48, 110	120071-0036	8A4000-32	51, 113
120066-8499	885033H09M010	106	120067-8064	8830P6E03M010	109	120071-0037	8A4001-31	51, 113
120067-0027	8040P0A09M020	46	120067-8068	8830P7E03M010	109	120071-0038	8A4006-31	51, 113
120067-0037	8830P6A09M010	47	120067-8087	8830P9P03M010	110	120071-0039	8A4006-32	51, 113
120067-0040	8830P6K05M010	47, 109	120067-8211	8840P9P03M010	110	120071-0040	8A4007-31	51, 113
120067-0046	8830P7A09M010	47	120067-8255	8840P6P03M010	109	120071-0041	8A5000-31	51, 113
120067-0058	8830P7B03M010	47	120067-8295	8830P7H09M010	109	120071-0043	8A5000-32	51, 113, 286, 329
120067-0065	8830P7K05M010	47, 109	120067-8308	8030P1H09M020	108	120071-0044	8A5001-31	51, 113
120067-0072	8830P8K05M010	48, 110	120067-8309	8040P1H09M020	108	120071-0045	8A5006-31	51, 113
120067-0074	8830P9A09M010	48	120067-8327	8040P0H09M020	108	120071-0047	8A5006-32	51, 113, 286, 329

Order No. Index

<i>Order No.</i>	<i>Engineering No.</i>	<i>Page</i>	<i>Order No.</i>	<i>Engineering No.</i>	<i>Page</i>	<i>Order No.</i>	<i>Engineering No.</i>	<i>Page</i>
120071-0049	8A5007-31	51, 113	120073-0357	776030D02F030	64	120079-0281	W05001E03M020	82, 325
120072-0061	702000D02F060	62	120073-0376	776031D02F030	64	120079-5001	W0C000H45M020	20, 82
120072-0085	702001D02F060	62	120073-0390	774033A03F030	65	120079-5006	W0C006H45M020	21, 83
120072-0108	702006D02F060	63	120073-0391	774030A03F030	64	120079-5023	W08000H08M020	82
120072-0118	702007D02F060	63	120073-0577	776032D02F030	65	120079-5026	W08006H08M020	83
120072-0130	703000A03F060	62	120073-5009	772031D02F030	64	120079-5029	W08S00P19M020	24, 86
120072-0171	703000D02F060	62	120073-5010	772032D02F030	65	120079-5033	W08S06P19M020	24, 86
120072-0219	703001A03F060	62	120073-5011	774033D02F030	65	120079-5048	W03001E03M020	82
120072-0250	703001D02F060	62	120073-5012	775031A03F030	64	120079-5055	W05006P03M020	83
120072-0292	703006A03F060	63	120073-5013	775032D02F030	65	120079-5088	W05001P03M020	82
120072-0302	703006D02F060	63	120073-5014	776033D02F030	65	120079-5102	W03000E03M020	82
120072-0315	703007A03F060	63	120074-0014	7R2A00A19A120	66	120079-5103	W03000P03M020	82
120072-0318	703007D02F060	63	120074-0030	7R2A06A19A120	67	120079-5104	W03001P03M020	82
120072-0334	704000A03F060	62	120074-0042	7R2006A19A120	67	120079-5105	W03006E03M020	83
120072-0356	704000D02F060	62	120074-0058	7R3A00A19A120	66	120079-5106	W03006P03M020	83
120072-0387	704001A03F060	62	120074-0079	7R3A06A19A120	67	120079-5107	W03007E03M020	83
120072-0402	704001D02F060	62	120074-0106	7R3006A19A120	67	120079-5108	W04007E03M020	83
120072-0435	704006A03F060	63	120074-0122	7R4A00A19A120	66	120079-5109	W04007P03M020	83
120072-0445	704006D02F060	63	120074-0140	7R4A06A19A120	67	120079-5110	W05000P03M020	82
120072-0459	705000A03F060	62	120074-0160	7R4006A19A120	67	120079-5111	W05007E03M020	83
120072-0471	705000D02F060	62	120074-0178	7R5A00A19A120	66	120079-5112	W05007P03M020	83
120072-0508	705001A03F060	62	120074-0190	7R5A06A19A120	67	120079-5113	W08000P02M020	20, 82
120072-0515	705001D02F060	62	120074-0222	7R5006A19A120	67	120079-5114	W08001P02M020	20, 82
120072-0546	705006A03F060	63	120075-0014	7A3000-31	68	120079-5115	W08006P02M020	21, 83
120072-0551	705006D02F060	63	120075-0015	7A3000-32	68	120079-5116	W08007P02M020	21, 83
120072-0558	705007D02F060	63	120075-0016	7A3001-31	68	120079-5117	W0C001H45M020	20, 82
120072-0568	706000D02F060	62	120075-0017	7A3006-31	68	120079-5118	W0C007H45M020	21, 83
120072-0595	706001D02F060	62	120075-0018	7A3006-32	68	120079-8006	W04006P03M020	83
120072-0616	706006D02F060	63	120075-0019	7A3007-31	68	120079-8012	W04000P03M020	82
120072-0626	706007D02F060	63	120079-0092	W05006A09M020	21	120079-8013	W04001P03M020	82
120072-1010	705007A03F060	63	120079-0107	W04006A09M020	21	120079-8041	W03007H09M020	83
120072-1022	704007D02F060	63	120079-0109	W05000A09M020	20, 283, 323	120079-8042	W03000H09M020	82
120072-5019	704007A03F060	63	120079-0130	W03000K05M020	20, 82	120079-8043	W08001H08M020	82
120073-0057	772030D02F030	64	120079-0138	W03000A09M020	20	120079-8044	W08007H08M020	83
120073-0068	772033D02F030	65	120079-0149	W04000K05M020	20, 82	120079-8045	W05000H09M020	82
120073-0085	773030A03F030	64	120079-0155	W03006K05M020	21, 83	120079-8046	W05006H09M020	83
120073-0100	773030D02F030	64	120079-0156	W04006K05M020	21, 83	120079-8047	W03001H09M020	82
120073-0140	773031A03F030	64	120079-0164	W04000A09M020	20	120079-8048	W05001H09M020	82
120073-0151	773031D02F030	64	120079-0175	W03006A09M020	21	120079-8049	W03006H09M020	83
120073-0172	773032A03F030	65	120079-0187	W04007A09M020	21	120079-8050	W05007H09M020	83
120073-0178	773032D02F030	65	120079-0192	W04007K05M020	21, 83	120079-8051	W04001H09M020	82
120073-0185	773033A03F030	65	120079-0211	W03001K05M020	20, 82	120079-8052	W04007H09M020	83
120073-0190	773033D02F030	65	120079-0216	W03001A09M020	20	120079-8053	W04006H09M020	83
120073-0215	774030D02F030	64	120079-0220	W03007A09M020	21	120079-8054	W04000H09M020	82
120073-0237	774031A03F030	64	120079-0221	W04001K05M020	20, 82	120080-0001	WW4A30A09M003	28
120073-0241	774031D02F030	64	120079-0223	W05001A09M020	20, 283, 323	120080-0005	WW4A31A09M003	28
120073-0246	774032A03F030	65	120079-0226	W03007K05M020	21, 83	120080-0033	8W4A30A09M003	28
120073-0250	774032D02F030	65	120079-0232	W04001A09M020	20	120080-0037	8W4A31A09M003	28
120073-0272	775030A03F030	64	120079-0239	W05007A09M020	21	120080-0081	WW4A30K05M003	28, 90
120073-0293	775030D02F030	64	120079-0263	W04006E03M020	83	120080-0089	WW4A31K05M003	28, 90
120073-0335	775031D02F030	64	120079-0266	W04000E03M020	82	120080-0108	8W4A30K05M003	28, 90
120073-0346	775032A03F030	65	120079-0269	W04001E03M020	82	120080-0116	8W4A31K05M003	28, 90
120073-0351	775033A03F030	65	120079-0273	W05006E03M020	83	120080-0276	WW3030A09M010	22
120073-0354	775033D02F030	65	120079-0277	W05000E03M020	82, 325	120080-0281	WW3032K05M010	23, 85

Order No. Index

<i>Order No.</i>	<i>Engineering No.</i>	<i>Page</i>	<i>Order No.</i>	<i>Engineering No.</i>	<i>Page</i>	<i>Order No.</i>	<i>Engineering No.</i>	<i>Page</i>
120080-0286	WW3031K05M010	22, 84	120080-5092	8W4A30E03M003	90	120084-5187	WR8W46E02C300	26, 88
120080-0300	WW4031K05M010	22, 84	120080-5093	8W4A30P03M003	90	120084-5188	WRCW46E01C300	26, 88
120080-0306	WW4032K05M010	23, 85	120080-5094	8W4A31E03M003	90	120084-5189	WR4W40E03C3003	87
120080-0325	WW5030A09M010	22, 284, 324	120080-5095	8W4A31P03M003	90	120084-5190	WR5W40E03C3003	87
120080-0337	WW4031A09M010	22	120080-8024	8W4A31H09M003	90	120084-5191	WR8W40E02C300	25, 87
120080-0347	WW4032A09M010	23	120080-8025	WW3033H09M010	85	120084-5192	WRCW40E01C300	25, 87
120080-0351	WW3033A09M010	23	120080-8026	WW3030H09M010	84	120085-0003	WA4006-31	27, 89
120080-0364	WW3033K05M010	23, 85	120080-8027	WW4031H09M010	84	120085-0004	WA5006-31	27, 89
120080-0378	WW5032A09M010	23	120080-8028	WW5031H09M010	84	120085-0005	WA4006-32	27, 89
120080-0382	WW5031A09M010	22	120080-8029	WW3032H09M010	85	120085-0006	WA5006-32	27, 89, 286, 329
120080-0391	WW4033A09M010	23	120080-8030	WW3031H09M010	84	120085-0007	WA4007-31	27, 89
120080-0396	WW4033K05M010	23, 85	120080-8031	WW4030H09M010	84	120085-0008	WA5007-31	27, 89
120080-0403	WW4030A09M010	22	120080-8032	WW8033H08M010	85	120085-0011	WA4000-31	27, 89
120080-0414	WW3030K05M010	22, 84	120080-8033	WW8030H08M010	84	120085-0012	WA5000-31	27, 89
120080-0417	WW4030K05M010	22, 84	120080-8034	WW8031H08M010	84	120085-0013	WA4000-32	27, 89
120080-0419	WW3032A09M010	23	120080-8035	WW8032H08M010	85	120085-0014	WA5000-32	27, 89, 286, 329
120080-0429	WW3031A09M010	22	120080-8036	WW4032H09M010	85	120085-0015	WA4001-31	27, 89
120080-0431	WW5033A09M010	23, 284, 324	120080-8037	WW4033H09M010	85	120085-0016	WA5001-31	27, 89
120080-0469	WW4030E03M010	84	120080-8038	WW5032H09M010	85	120086-0009	4030P1B09M020	70
120080-5023	WWC033H45M010	23, 85	120080-8039	WW5030H09M010	84	120086-0022	403001B09M020	70
120080-5045	WW4030P03M010	84	120080-8040	WW5033H09M010	85	120086-0027	403006B09M020	71
120080-5050	WW5030P03M010	84	120080-8048	WW4A30H09M003	90	120086-0033	403007B09M020	71
120080-5058	WW3030E03M010	84	120080-8049	WW4A31H09M003	90	120086-0042	404001B09M020	70
120080-5059	WW3030P03M010	84	120082-8004	8W4A30H09M003	90	120086-0048	404006B09M020	71
120080-5060	WW3031E03M010	84	120083-5010	WOC500P45M020	24, 86	120086-0052	404007B09M020	71
120080-5061	WW3031P03M010	84	120083-5015	WOC506P45M020	24, 86	120086-0102	403000A10M020	70
120080-5062	WW3032E03M010	85	120083-5044	WWC530P45M010	24, 86	120086-0119	403001A10M020	70
120080-5063	WW3032P03M010	85	120083-5183	WW8530P19M010	24, 86	120086-0132	403006A10M020	71
120080-5064	WW3033E03M010	85	120084-0007	WR4000A18C300	25	120086-0139	403007A10M020	71
120080-5065	WW3033P03M010	85	120084-0008	WR4006A18C300	26	120086-0144	404000A10M020	70
120080-5066	WW4031E03M010	84	120084-0016	WR5000A18A120	285, 327	120086-0171	404000B09M020	70
120080-5067	WW4031P03M010	84	120084-0016	WR5000A18C300	25	120086-0175	404001A10M020	70
120080-5068	WW4032E03M010	85	120084-0017	WR5006A18C300	26	120086-0183	404006A10M020	71
120080-5069	WW4032P03M010	85	120084-0047	WR8W460003	26, 88	120086-0186	404007A10M020	71
120080-5070	WW4033E03M010	85	120084-0048	WR8W400003	25, 87	120086-0191	405000A10M020	70
120080-5071	WW4033P03M010	85	120084-5013	WRCU20E01C3003	25, 87	120086-0196	405000B09M020	70
120080-5072	WW4A30E03M003	90	120084-5015	WRCU26E01C3003	26, 88	120086-0200	405001A10M020	70
120080-5073	WW4A30P03M003	90	120084-5095	WR8U20E02C3003	25, 87	120086-0206	405006A10M020	71
120080-5074	WW4A31E03M003	90	120084-5096	WR8U26E02C3003	26, 88	120086-0210	405007A10M020	71
120080-5075	WW4A31P03M003	90	120084-5103	WR4J26E03C3003	88	120086-0336	403000B09M020	70
120080-5076	WW5030E03M010	84, 326	120084-5107	WR4U20E03C3003	87	120086-0386	405001B09M020	70
120080-5077	WW5031E03M010	84	120084-5108	WR4U26E03C3003	88	120086-0387	405006B09M020	71
120080-5078	WW5031P03M010	84	120084-5109	WR5J26E03C3003	88	120086-0390	405007B09M020	71
120080-5079	WW5032E03M010	85	120084-5113	WR5U20E03C3003	87	120086-0421	4030P1A10M020	70
120080-5080	WW5032P03M010	85	120084-5154	WR4J20E03C3003	87	120086-8001	403000P02M020	126
120080-5081	WW5033E03M010	85, 326	120084-5159	WR5J20E03C3003	87, 328	120086-8061	405007P02M020	127
120080-5082	WW5033P03M010	85	120084-5175	WR4W400003	25, 87	120086-8083	405007E02M020	127
120080-5083	WW8030P02M010	22, 84	120084-5176	WRCW400003	25, 87	120086-8099	405000E02M020	126
120080-5084	WW8031P02M010	22, 84	120084-5179	WR5W400003	25, 87	120086-8155	403001P02M020	126
120080-5085	WW8032P02M010	23, 85	120084-5180	WR4W460003	26, 88	120086-8156	404000P02M020	126
120080-5086	WW8033P02M010	23, 85	120084-5181	WR5W460003	26, 88	120086-8159	404001P02M020	126
120080-5088	WWC030H45M010	22, 84	120084-5182	WRCW460003	26, 88	120086-8173	405006E02M020	127
120080-5089	WWC031H45M010	22, 84	120084-5183	WR4W46E03C3003	88	120086-8178	405001E02M020	126
120080-5090	WWC032H45M010	23, 85	120084-5185	WR5W46E03C3003	88	120086-8228	403006E02M020	127

Order No. Index

<i>Order No.</i>	<i>Engineering No.</i>	<i>Page</i>	<i>Order No.</i>	<i>Engineering No.</i>	<i>Page</i>	<i>Order No.</i>	<i>Engineering No.</i>	<i>Page</i>
120086-8329	403007P02M020	127	120088-8122	503000H08M020	135	120098-0181	BP5S63PP4M010	317
120086-8337	4030P1P02M020	126	120088-8123	504000P02M020	135	120098-0183	BP5S32PP4M010	317
120086-8368	404006E02M020	127	120088-8124	504001E02M020	135	120098-0184	BM5S31PP4M010	317
120086-8373	404006P02M020	127	120088-8125	504001P02M020	135	120098-0186	BM5G62PP4M010	318
120086-8382	404007P02M020	127	120088-8126	504001H08M020	135	120098-0188	BM5G63PP4M010	318
120086-8391	405001P02M020	126	120088-8127	504006H08M020	135	120098-0190	BM5G30PP4M010	318
120087-0074	443030A10M010	72	120088-8128	503001H08M020	135	120098-0192	BM5G32PP4M010	318
120087-0088	443033A10M010	72	120088-8129	503006H08M020	135	120098-0194	BM5G31PP4M010	318
120087-0093	444030A10M010	72	120088-8130	503006P02M020	135	120098-0196	BM5G33PP4M010	318
120087-0103	444031A10M010	72	120088-8131	504006P02M020	135	120098-0198	MM3S60PP4M010	315
120087-0108	444033A10M010	72	120089-5002	444A30	78	120098-0199	MP3S62PP4M010	315
120087-0112	445030A10M010	72	120090-0016	4R3P00A27C300	73	120098-0200	MM3S62PP4M010	315
120087-0117	445033A10M010	72	120090-0020	4R3P06A27C300	74	120098-0202	M03S06PP4M010	314
120087-0243	443031A10M010	72	120090-0029	4R4P00A27C300	73	120098-0203	P03S07PP4M010	314
120087-0253	443032A10M010	72	120090-0032	4R4P06A27C300	74	120098-0204	MM3G60PP4M010	316
120087-0281	444032A10M010	72	120090-0037	4R5P00A27C300	73	120098-0206	MP3G62PP4M010	316
120087-0287	445031A10M010	72	120090-0038	4R5P06A27C300	74	120098-0207	MM3G61PP4M010	316
120087-0290	445032A10M010	72	120090-5001	4R3H400013	73	120098-0209	MP3G63PP4M010	316
120087-8140	443030P02M010	128	120091-0001	N03FA03124	75, 131	120098-0211	MM3G70PP4M010	316
120087-8258	443030E02M010	128	120091-0003	N03FA04124	75, 131	120098-0213	MP3G72PP4M010	316
120087-8316	443031P02M010	128	120091-0004	N03MA03124	75, 131	120098-0223	BM5S61PP4M010	317
120087-8321	443032E02M010	128	120091-0006	N03MA04124	75, 131	120098-5007	BM5S33PP4M010	317
120087-8324	443032P02M010	128	120091-0007	N04FA03124	75, 131	120098-5021	BB5S31PP4M010	306
120087-8329	443033E02M010	128	120091-0009	N04FA04124	75, 131	120098-8025	M03S07PP4M010	314
120087-8349	444030E02M010	128	120091-0010	N04MA03124	75, 131	120098-8035	MM3G72PP4M010	316
120087-8359	444030P02M010	128	120091-0012	N04MA04124	75, 131	120099-0001	BR5L30	309
120087-8365	444031E02M010	128	120094-0044	K03001P80M100	32, 57, 94, 119, 180	120099-0005	BR5U70PP4M0103	307
120087-8372	444031P02M010	128	120094-0125	K02101P80M100	31, 55, 93, 118, 180	120099-0013	BR5U76PP4M0103	307
120087-8380	444033P02M010	128	120094-5003	K03000P80M100	180	120099-0024	81689-030	308
120087-8502	443033P02M010	128	120094-5022	K02100P80M100	180	120099-0025	81688-030	308
120087-8503	444032E02M010	128	120094-5023	K02301P80M100	31, 55, 93, 118	120100-0001	BA5S00-32	310
120087-8504	444032P02M010	128	120094-8013	K02201P80M100	31, 55, 93	120100-0002	BA5S06-32	310
120087-8507	444033E02M010	128	120094-8027	K03201P80M100	32, 57, 94, 119	120100-0003	MA9DPO-32	313
120088-0001	5030P1B09M020	79	120094-8045	K03301P80M100	32, 57, 94	120100-0004	MA9D00-32	313
120088-0002	503000B09M020	79	120098-0006	BB5S30PP4M010	306	120101-0001	PBAPT	152, 322
120088-0014	504006B09M020	79	120098-0024	BB5S32PP4M010	306	120101-0002	PDT501	312
120088-0022	503000A10M020	79	120098-0029	BB5S33PP4M010	306	120102-0002	B05S06	311
120088-0032	503001A10M020	79	120098-0048	BM5G70PP4M010	318	120103-0001	PA9D01-42	313
120088-0040	503001B09M020	79	120098-0051	BM5G72PP4M010	318	120103-0003	PA9D0B-42	313
120088-0042	503006A10M020	79	120098-0057	BM5S32PP4M010	317	120103-0005	PA9S01-42	313
120088-0054	504001A10M020	79	120098-0062	BM5S60PP4M010	317	120103-5001	MA9D00-42	313
120088-0059	504006A10M020	79	120098-0065	BM5S62PP4M010	317	120108-0042	EWWA06015M010	365
120088-0099	5030P1A10M020	79	120098-0070	BM5S63PP4M010	317	120108-0050	EWWA06215M010	365
120088-0112	503006B09M020	79	120098-0077	BP5S33PP4M010	317	120108-0058	EWWA06315M010	365
120088-0116	504000B09M020	79	120098-0079	BP5S62PP4M010	317	120108-0066	EWWA06003M010	365
120088-0130	504001B09M020	79	120098-0084	B05S00PP4M010	304	120108-0074	EWWA06203M010	365
120088-8001	503000E02M020	135	120098-0099	B05S06PP4M010	305	120108-0082	EWWA06303M010	365
120088-8083	503000P02M020	135	120098-0120	MM3S63PP4M020	315	120108-0090	EWWA06010M010	365
120088-8086	503001E02M020	135	120098-0122	MP3S63PP4M020	315	120108-0098	EWWA06210M010	365
120088-8090	503001P02M020	135	120098-0150	BM5G60PP4M010	318	120108-0106	EWWA06310M010	365
120088-8093	503006E02M020	135	120098-0151	BM5G61PP4M010	318	120108-0167	E11A06304M010	361
120088-8095	504000E02M020	135	120098-0155	BM5S30PP4M010	317	120108-0174	E11A06305M010	361
120088-8120	504006E02M020	135				120108-0186	E10A00605M010	360
120088-8121	504000H08M020	135				120108-0187	E10A00705M010	360

Order No. Index

<i>Order No.</i>	<i>Engineering No.</i>	<i>Page</i>	<i>Order No.</i>	<i>Engineering No.</i>	<i>Page</i>	<i>Order No.</i>	<i>Engineering No.</i>	<i>Page</i>
120108-0188	E11A06005M010	361	120114-0087	BTY8030-FBB	56, 117	120230-0078	KAS9S01-425	174
120108-0189	E11A06205M010	361	120114-0089	BTY805P-FBP-05	60, 122	120230-0084	KASCS01-025	174
120108-0200	E11A06311M020	361	120114-0092	BTY8050-FBP-05	60, 122	120230-0090	KASHS01-025	174
120108-0201	E11A06211M020	361	120114-0095	BTY812N-FBP-05	61, 123	120230-0096	KASJS01-025	174
120108-0236	E11A06011M010	361	120114-0097	BTY812P-FBP-05	61, 123	120230-0102	KASLS01-225	174
120108-0252	ERWPAU7011M010	370	120114-0099	BTY8120-FBP-050	61, 123	120230-0110	KAS6S06-405	175
120108-0264	E16A03011M010	363	120114-0192	BTY412N-FBP-05	61, 123	120230-0119	KAS7S06-405	175
120108-5020	EWWA06304M010	365	120114-0202	BTY805N-FBP-05	60, 122	120230-0128	KAS9S06-415	175
120109-0004	ERWAAJ3000C050	367	120114-0211	BTY401N-FBC	55, 118	120230-0137	KASCS06-015	175
120109-0005	ERWPAU7003M006	370	120114-8008	BTY400N-FBP-05	59, 121	120230-0146	KASHS06-015	175
120109-5001	ERWAAU3000C050	367	120114-8011	BTY400P-FBP-05	59, 121	120230-0155	KASJS06-015	175
120109-5002	ERWAAU7000C050	367	120114-8020	BTY800N-FBP-05	59, 121	120230-0164	KASLS06-115	175
120109-5003	ERWD2J30	368	120114-8022	BTY800P-FBP-05	59, 121	120231-0002	KRS6G20-403	176
120109-5004	ERWD2U30	368	120119-0001	BKY400P-FBP-05	34, 96	120231-0005	KRS7G20-403	176
120109-5005	ERWD2U70	368	120119-0002	BKY401P-FBB	29, 91	120231-0008	KRS9G20-423	176
120113-0002	BEYA01P-FBP-05	77, 133	120119-0003	BKY401P-FBC	31, 93	120231-0011	KRSCG20-023	176
120113-0006	BEY401P-FBP-05	77, 133	120119-0004	BKY403P-FBA	33, 95	120231-0014	KRSHG20-023	176
120113-0011	BEY601P-FBP-05	77, 133	120119-0005	BKY403P-FBB	30, 92	120231-0017	KRSJG20-023	176
120113-0014	BEY801P-FBP-05	77, 133	120119-0006	BKY403P-FBC	32, 94	120231-0020	KRSLG20-223	176
120113-0017	BEY803P-FBP-05	78, 134	120119-0007	BKY405P-FBP-05	35, 97	120231-0023	KRS6G26-4031	177
120113-0020	BNYA01P-FBC	76, 132	120119-0008	BKY4120-FBP-01	36, 98	120231-0026	KRS7G26-4031	177
120113-0022	BNYA01P-FBP-05	77, 133	120119-0009	BKY600P-FBP-05	34, 96	120231-0029	KRS9G26-4131	177
120113-0023	BNY401P-FBC	76, 132	120119-0010	BKY601P-FBB	29, 91	120231-0032	KRSCG26-0131	177
120113-0025	BNY401P-FBP-05	77, 133	120119-0011	BKY601P-FBC	31, 93	120231-0035	KRSHG26-0131	177
120113-0026	BNY601P-FBC	76, 132	120119-0012	BKY603P-FBA	33, 95	120231-0038	KRSJG26-0131	177
120113-0029	BNY801P-FBC	76, 132	120119-0013	BKY603P-FBB	30, 92	120231-0041	KRSLG26-1131	177
120113-0032	BNY801P-FBP-05	77, 133	120119-0015	BKY605P-FBP-05	35, 97	120231-0044	KRS6G27-4012	177
120113-5100	BNY403P-FBP-05	78, 134	120119-0016	BKY800P-FBP-05	34, 96	120231-0047	KRS7G27-4012	177
120114-0014	BTY401N-FBB	54, 116	120119-0017	BKY801P-FBB	29, 91	120231-0050	KRS9G27-4112	177
120114-0019	BTY401P-FBB	54, 116	120119-0018	BKY801P-FBC	31, 93	120231-0053	KRSCG27-0112	177
120114-0020	BTY401P-FBC	55, 118	120119-0019	BKY803P-FBA	33, 95	120231-0056	KRSHG27-0112	177
120114-0027	BTY4010-FBB	54, 116	120119-0020	BKY803P-FBB	30, 92	120231-0059	KRSJG27-0112	177
120114-0029	BTY403P-FBA	58, 120	120119-0021	BKY803P-FBC	32, 94	120231-0062	KRSLG27-1112	177
120114-0030	BTY403P-FBB	56, 117	120119-0023	BKY805P-FBP-05	35, 97	120231-0066	KRS6G46-4041	178
120114-0031	BTY403P-FBC	57, 119	120119-0025	BKY8120-FBP-01	36, 98	120231-0070	KRS7G46-4041	178
120114-0034	BTY4030-FBA	58, 120	120119-0038	BKY4030-FBC	32, 94	120231-0074	KRS9G46-4141	178
120114-0035	BTY4030-FBB	56, 117	120149-0016	4R3L40001	129	120231-0078	KRSCG46-0141	178
120114-0037	BTY405N-FBP-05	60, 122	120149-0064	4R4L40001	129	120231-0082	KRSHG46-0141	178
120114-0039	BTY405P-FBP-05	60, 122	120149-0095	4R5L40001	129	120231-0086	KRSJG46-0141	178
120114-0042	BTY4050-FBP-05	60, 122	120155-0012	KS-TOOL-01	185	120231-0090	KRSLG46-1141	178
120114-0045	BTY412P-FBP-05	61, 123	120155-0013	KS-LOC-01	185	120231-0094	KRS6P46-400	179
120114-0048	BTY4120-FBP-05	61, 123	120155-0014	KS-LOC-02	185	120231-0098	KRS7P46-400	179
120114-0055	BTY601P-FBB	54, 116	120155-0015	KS-TOOL-02	185	120231-0102	KRS9P46-410	179
120114-0056	BTY603P-FBA	58, 120	120155-0016	KA-FLANGE	185	120231-0106	KRSCP46-010	179
120114-0057	BTY6030-FBA	58, 120	120155-0017	KP-TOOL-01	185	120231-0110	KRSHP46-010	179
120114-0059	BTY801N-FBB	54, 116	120155-0018	KP-LOC-01	185	120231-0114	KRSJP46-010	179
120114-0060	BTY801N-FBC	55, 118	120155-0019	KP-LOC-02	185	120231-0118	KRSLP46-110	179
120114-0065	BTY801P-FBB	54, 116	120230-0005	KAS6S00-405	174	120233-0001	KAP6S00-105	181
120114-0066	BTY801P-FBC	55, 118	120230-0014	KAS7S00-405	174	120233-0005	KAP8S00-115	181
120114-0079	BTY8010-FBB	54, 116	120230-0023	KAS9S00-425	174	120233-0009	KAP6S01-105	181
120114-0082	BTY803P-FBA	58, 120	120230-0032	KASCS00-025	31, 55, 93, 118, 174	120233-0013	KAP8S01-115	181
120114-0083	BTY803P-FBB	56, 117	120230-0041	KASHS00-025	174	120233-0017	KAP6S06-105	182
120114-0084	BTY803P-FBC	57, 119	120230-0050	KASJS00-025	174	120233-0021	KAP8S06-115	182
120114-0086	BTY8030-FBA	58, 120	120230-0072	KAS7S01-405	174	120234-0001	KRP6G00-103	183

Order No. Index

<i>Order No.</i>	<i>Engineering No.</i>	<i>Page</i>	<i>Order No.</i>	<i>Engineering No.</i>	<i>Page</i>	<i>Order No.</i>	<i>Engineering No.</i>	<i>Page</i>
120234-0003	KRP8G00-113	183	121040-0491	E432N2N10011	196	130006-1675	106002A01F060	141
120234-0005	KRP6G06-103	184	121040-0493	E432N2N10K11	196	130006-2099	40925	151
120234-0007	KRP8G06-113	184	121040-0496	E432N2N20011	196	130006-2102	41037	151
120234-0009	KRP6G07-1012	184	121040-0500	E432N2N50011	196	130006-2103	41132	151
120234-0011	KRP8G07-1112	184	121040-0511	E433N2N50021	196	130006-2107	41344	151
120234-0013	KRP6G07-1052	184	121040-0589	E152N3N50011	193	130006-2109	41593	151
120234-0015	KRP8G07-1152	184	121040-0703	E333N2N10K21	197	130007-0024	206000A01F060	158
120234-0017	KRP6G46-1031	184	121040-0887	E333N2N50021	197	130007-0051	206002A01F060	159
120234-0019	KRP8G46-1131	184	121040-1109	E433N2N10K21	196	130007-0073	207000A01F060	158
120234-0021	KRP6P46-100	184	121040-1257	E153N3N10K21	193	130007-0076	207000A01F120	155
120234-0023	KRP8P46-110	184	121040-1258	E433N2N10021	196	130007-0115	207002A01F060	159
120244-0002	1202440002	372	121040-1259	E433N2N20021	196	130007-0142	208000A01F060	158
120244-0201	1202440201	372	121040-1260	E333N2N10021	197	130007-0145	208000A01F120	154
120244-0202	1202440202	372	121201-0001	C28200N0R	188	130007-0199	208002A01F060	159
120244-0203	1202440203	372	121201-0002	C28300N0R	188	130008-0025	301000A01F060	164
120244-0204	1202440204	372	121202-0002	C22200N0R	189	130008-0028	301000A01F120	154
120244-0205	1202440205	372	121203-0001	C92200N0T	190	130008-0098	301001A01F060	164
120244-0207	1202440207	372	121204-0001	C25200N0T	191	130008-0117	301002A01F060	165
120341-0075	1203410075	373	121204-0005	C25300N0T	191	130008-0157	302000A01F060	164
120341-0150	1203410150	373	121205-0001	C29200N0T	192	130008-0161	302000A01F120	155
120341-0300	1203410300	374	121205-0005	C29300N0T	192	130008-0212	302001A01F060	164
120341-0301	1203410301	374	130006-0091	102000A01F060	138	130008-0231	302002A01F060	165
120341-0302	1203410302	374	130006-0137	102001A01F060	138	130008-0303	303000P80M050	169
120341-0303	1203410303	374	130006-0159	102002A01F060	141	130008-0315	303001P80M050	169
120341-0304	1203410304	374	130006-0221	103000A01F060	138	130008-0316	303001P80M100	30, 56, 92, 117
120341-0305	1203410305	374	130006-0232	103000A01F120	156	130008-0325	309000A01F060	164
120341-0306	1203410306	374	130006-0279	103000A02F060	138	130008-0329	309000A01F120	155
120355-0014	1203550014	372	130006-0302	103000A03F060	138	130008-0351	309001A01F060	164
120355-0015	1203550015	372	130006-0339	103000A06M020	138	130008-0366	309002A01F060	165
120355-0016	1203550016	372	130006-0377	103000C01F060	138	130008-0476	302101P80M100	29, 54, 91, 116
120355-0017	1203550017	372	130006-0426	103001A01F060	138	130008-5006	303201P80M100	30, 56, 92, 117
120355-0018	1203550018	372	130006-0452	103001A02F060	138	130008-8006	302201P80M100	29, 54, 91, 116
120355-0020	1203550020	372	130006-0534	103002A01F060	141	130008-8009	302301P80M100	29, 54, 91, 116
120355-0056	1203550056	372	130006-0647	103003A01F060	141	130010-0103	115030K13M020	143, 319
121012-0009	B152000N2	191	130006-0728	104000A01F060	139	130010-0119	115033K13M020	319
121012-0010	B153000N2	191	130006-0813	104000A03F060	139	130010-0147	112020A01F060	142
121012-0013	B202000N2	188	130006-0833	104000A05M020	139	130010-0221	113020A01F060	142
121012-0019	B203000N2	188	130006-0868	104000C01F060	139	130010-0307	113020C01F060	142
121012-0102	B292000N2	192	130006-0902	104001A01F060	139	130010-0488	113030K13M020	143, 157
121040-0140	E152N3N10011	193	130006-0995	104002A01F060	141	130010-0525	114020A01F060	142
121040-0146	E152N3N10K11	193	130006-1087	104003A01F060	141	130010-0795	114030A38M020	143, 278
121040-0159	E152N3N20011	193	130006-1163	105000A01F060	139	130010-0865	114030K12M020	143, 157, 278
121040-0210	E153N3N10021	193	130006-1240	105000A02F060	140	130010-1005	115020A01F060	142
121040-0219	E153N3N20021	193	130006-1257	105000A03F060	140	130010-1256	115030A01M020	319
121040-0230	E153N3N50021	193	130006-1275	105000A07M020	140	130010-1303	115033A01M020	319
121040-0230	E153N3N50021	193	130006-1275	105000A07M020	140	130010-1316	116020A01F060	142
121040-0295	E162N3N10021	194	130006-1312	105000C01F060	140	130010-1657	41627-M010	218
121040-0299	E162N3N10K21	194	130006-1349	105001A01F060	139	130010-1744	114033K12M020	278
121040-0305	E162N3N20021	194	130006-1382	105001A02F060	140	130010-1823	114033A38M020	278
121040-0320	E162N3N50021	194	130006-1404	105001A07M020	140	130011-0010	226020A01F060	160
121040-0422	E332N2N10011	197	130006-1438	105002A01F060	141	130011-0051	227020A01F060	160
121040-0428	E332N2N10K11	197	130006-1518	105003A01F060	141	130011-0119	228020A01F060	160
121040-0436	E332N2N20011	197	130006-1583	106000A01F060	140	130012-0009	331020A01F060	166
121040-0451	E332N2N50011	197	130006-1590	106000A01F120	154	130012-0113	332020A01F060	166
121040-0470	E333N2N20021	197	130006-1653	106001A01F060	140			

Order No. Index

<i>Order No.</i>	<i>Engineering No.</i>	<i>Page</i>	<i>Order No.</i>	<i>Engineering No.</i>	<i>Page</i>	<i>Order No.</i>	<i>Engineering No.</i>	<i>Page</i>
130012-0339	333030P80M050	169	130014-0078	2R8006A20A120	162	130025-0013	DNDF19A-M010	243
130012-0385	339020A01F060	166	130015-0024	3R1004A20A120	167	130025-0054	DN11A-M010	242
130013-0060	1R2004A20A120	145	130015-0044	3R1006A20A120	168	130025-0173	DN91A-M010	242
130013-0074	1R2005A20A120	145	130015-0054	3R2004A20A120	167	130025-0197	DN99A-M010	242
130013-0076	1R2006A20A120	146	130015-0076	3R2006A20A120	168	130025-0233	DNB11A-M010	242
130013-0090	1R2007A20A120	146	130015-0098	3R3N30E80C300	170	130025-0259	DNB91A-M010	242
130013-0093	1R2G04A20A120	145	130015-0109	3R3N36E80C300	170	130025-0267	DNB99A-M010	242
130013-0099	1R2G06A20A120	146	130015-0117	3R9004A20A120	167	130025-0287	DND11A-M010	243
130013-0112	1R3000A20M020	144	130015-0137	3R9006A20A120	168	130025-0313	DND19A-M010	243
130013-0135	1R3004A20A120	145	130017-0004	1A3000-34	150	130025-0322	DND91A-M010	243
130013-0184	1R3005A20A120	145	130017-0008	1A3002-34	150	130025-0352	DNE11A-M010	242
130013-0193	1R3006A17A120	146	130017-0011	1A3006-34	150	130025-0408	DNF11A-M010	242
130013-0202	1R3006A20A120	146	130017-0015	1A4000-34	150, 280	130025-0468	DNF91A-M010	242
130013-0229	1R3006A24A120	146	130017-0018	1A4002-34	150	130025-0482	DNF99A-M010	242
130013-0238	1R3006A25A120	147	130017-0020	1A4006-34	150, 280	130025-0502	DNDF11A-M010	243
130013-0247	1R3007A20A120	146	130017-0023	1A5000-34	150, 321	130025-0513	DNDF99A-M010	243
130013-0268	1R3D06A25A120	147	130017-0026	1A5002-34	150	130025-0538	DNF09A-M010	240
130013-0273	1R3G04A20A120	145	130017-0029	1A5006-34	150, 321	130025-0543	DND99A-M010	243
130013-0280	1R3G06A20A120	146	130017-0055	1A3000-34PWR	216	130025-0546	DNDF91A-M010	243
130013-0301	1R4000A39M020	144	130017-0056	1A3006-34PWR	216	130027-0012	DND02A-M010	257
130013-0314	1R4004A20A120	145	130017-0057	1A4000-34PWR	216	130027-0037	DND03A-M010	257
130013-0337	1R4005A20A120	145	130017-0058	1A4006-34PWR	216	130027-0048	DND20A-M010	256
130013-0341	1R4006A16A120	147	130018-0125	51180-M020	218	130027-0075	DND30A-M010	256
130013-0353	1R4006A20A120	147	130018-0184	51149	151	130027-0103	DNDF02A-M010	257
130013-0386	1R4007A20A120	147	130018-0204	40761	153	130027-0115	DNDF03A-M010	257
130013-0388	1R4030	149, 279	130018-0206	41048	153	130027-0161	DNDF30A-M010	256
130013-0396	1R4D06A16A120	147	130018-0207	41212	153	130027-0171	DNDF20A-M010	256
130013-0402	1R4G04A20A120	145	130018-0210	41481	153	130028-0028	DND22A-M010	258
130013-0409	1R4G06A20A120	147	130018-0217	61056	152	130028-0070	DND23A-M010	258
130013-0423	1R5000A20F060	320	130023-0055	L04101M78M100	76, 132	130028-0085	DND32A-M010	258
130013-0426	1R5000A20M020	144	130023-0059	L04201M78M100	76, 132	130028-0104	DND33A-M010	258
130013-0442	1R5004A20A120	145	130023-0063	L04301M78M100	76, 132	130028-0132	DNDF22A-M010	258
130013-0482	1R5005A20A120	145	130023-0068	L04A01M78M100	76, 132	130028-0163	DNDF23A-M010	258
130013-0489	1R5006A17A120	148	130024-0005	DNDF01A-M010	241	130028-0172	DNDF32A-M010	258
130013-0493	1R5006A20A120	148	130024-0028	DN01A-M010	240	130028-0183	DNDF33A-M010	258
130013-0515	1R5006A24A120	148	130024-0059	DN09A-M010	240	130029-0001	405000D12M010	272
130013-0534	1R5007A20A120	148	130024-0073	DN10A-M010	238	130029-0002	405001D12M010	272
130013-0541	1R5030	149, 247	130024-0133	DN90A-M010	238	130029-0003	405006D12M010	273
130013-0548	1R5D06A25A120	148	130024-0146	DNB01A-M010	240	130029-0005	405007D12M010	273
130013-0550	1R5G04A20A120	145	130024-0163	DNB09A-M010	240	130030-0003	445030D12M010	274
130013-0557	1R5G06A20A120	148	130024-0169	DNB10A-M010	238	130030-0004	445032D12M010	274
130013-0567	1R6004A20A120	145	130024-0178	DNB90A-M010	238	130030-0010	485030D12M010	276
130013-0589	1R6005A20A120	145	130024-0191	DND01A-M010	241	130030-0022	485033D12M010	276
130013-0593	1R6006A20A120	148	130024-0207	DND09A-M010	241	130030-0027	845030D12M010	275
130013-0612	1R6007A20A120	148	130024-0215	DND10A-M010	239	130030-0041	845031D12M010	275
130013-0614	1R6G04A20A120	145	130024-0232	DND90A-M010	239	130030-0061	845032D12M010	275
130013-0620	1R6G06A20A120	148	130024-0249	DNE01A-M010	240	130030-0070	845033D12M010	275
130013-0991	41671-0030	219	130024-0260	DNE10A-M010	238	130030-0088	445031D12M010	274
130013-1001	1R40301	279	130024-0265	DNF01A-M010	240	130030-0089	445033D12M010	274
130014-0015	2R6004A20A120	161	130024-0337	DNF10A-M010	238	130030-0090	485031D12M010	276
130014-0025	2R6006A20A120	162	130024-0341	DNF90A-M010	238	130030-0091	485032D12M010	276
130014-0037	2R7004A20A120	161	130024-0353	DNDF10A-M010	239	130031-0012	DNDC303A-M005	261
130014-0050	2R7006A20A120	162	130024-0355	DNDF90A-M010	239	130031-0014	DNDC230A-M010	261
130014-0061	2R8004A20A120	161	130024-0356	DNDF09A-M010	241	130031-0023	81611	262

Order No. Index

<i>Order No.</i>	<i>Engineering No.</i>	<i>Page</i>	<i>Order No.</i>	<i>Engineering No.</i>	<i>Page</i>	<i>Order No.</i>	<i>Engineering No.</i>	<i>Page</i>
130031-0026	81612	262	130039-0230	DNDC302A-M005	261	130048-0095	E11A06004M010	361
130033-0003	DNDC304-M005	271	130039-0245	DNDF13A-M010	260	130048-0114	E11A06010M010	361
130034-0005	1A5000-34DN	248	130039-0248	DNDF21A-M010	259	130048-0122	E11A06015M010	361
130034-0006	1A5006-34DN	248	130039-0257	DNDF29A-M010	259	130048-0137	E11A06203M010	361
130034-0007	8A5000-32DN	264	130039-0259	DNDF31A-M010	259	130048-0145	E11A06210M010	361
130034-0008	8A5006-32DN	264	130039-0263	DNDF39A-M010	259	130048-0153	E11A06215M010	361
130035-0007	115011A-PM-1	251	130039-0266	DNDF92A-M010	260	130048-0161	E11A06303M010	361
130035-0008	115011A-PM-3	251	130039-0284	DN5000-M010	245	130048-0170	E11A06310M010	361
130035-0013	115032A	253	130039-0299	DN5100-M010	245	130048-0179	E11A06315M010	361
130035-0015	115060A	253	130039-0312	DNB5000-M010	245	130048-0193	E11B03003M002	362
130035-0030	61451-ESIN	218	130039-0318	DNB5100-M010	245	130048-0195	E11B03015M002	362
130035-0031	61451-ESOUT	218	130039-0336	DN2100	255	130048-0197	E16A03003M010	363
130035-0057	DN3020	252	130039-0339	DNB00A-M500	235	130048-0207	E1WB03003M002	366
130035-0060	DN3020PM-1	250	130039-0340	DNB00A-T100	235	130048-0208	E1WB03010M002	366
130035-0061	DN3020PM-3	250	130039-0341	DND3020	252	130048-0209	E1WB03015M002	366
130035-0071	DN3200	252	130039-0344	DNDF00A-T100	236	130048-0281	E10A00611M050	360
130035-0072	DNAPT	282	130039-0346	DNDG00A-T100	237	130048-0286	E10A00711M050	360
130035-0077	DNESJ	282	130039-0347	DNE00A-M500	235	130050-0071	ENP1105M010	347
130035-0081	DNESJ	282	130039-0348	DNE00A-T100	235	130050-0076	ENP1115M010	348
130035-0085	DNETAUXPT	152, 282	130039-0349	DNF00A-M500	234	130050-0093	ENP1135M010	348
130035-0090	MICT555	266	130039-0350	DNF00A-T100	234	130050-0105	ENP1305M010	344
130036-0005	DN4000	254	130039-0351	115010A	253	130050-0107	ENP1335M010	345
130036-0006	DN4100	255	130039-0358	41437-001	219	130050-0112	ENP2105M010	347
130036-0008	DN6000	254	130039-0359	41437-002	219	130050-0122	ENP2115M010	348
130036-0009	DN6100	255	130039-0368	DN00A-M500	234	130050-0140	ENP2135M010	348
130036-0010	DN8000	254	130039-0369	DN00A-T100	234	130050-0150	ENP2335M010	345
130037-0004	DND4200	268	130039-0370	DN100	249	130050-0162	ENP3105M010	347
130037-0005	DND4300-02	267	130039-0371	DN100L	249	130050-0170	ENP3115M010	348
130037-0006	DND4500-02	267	130039-0376	DN150	249	130050-0251	ENQ3115M010	348
130037-0008	DND8200	268	130039-0381	DND00A-T100	236	130050-0262	ENQ3135M010	348
130037-0010	DND8300-02	267	130039-0382	DND100	265	130050-0277	ENS1105M010	347
130037-0011	DND8500-02	267	130039-0385	DND150	265	130050-0284	ENS1115M010	348
130038-0016	DNTA14114A1	277	130039-0386	DND151	265	130050-0324	ENS1335M010	345
130039-0072	DN150L	249	130039-0390	DN-PT1	281	130050-0328	ENS2105M010	347
130039-0087	DND5304-M010	271	130039-0391	DN-PT2	281	130050-0336	ENS2115M010	348
130039-0096	DN5210A-M010	244	130039-0393	DN-PT3	281	130050-0371	ENS2135M010	348
130039-0098	DN5290A-M010	244	130039-0396	DNYG001	266	130050-0392	ENS2305M010	344
130039-0101	DN5301A-M010	244	130039-0523	DNDF12A-M010	260	130050-0394	ENS2335M010	345
130039-0103	DN5309A-M010	244	130039-0545	DNDF40-M010	269	130050-0408	ENS3105M010	347
130039-0122	DND49A-M010	270	130039-0546	DNDF41A-M010	270	130050-0412	ENS3115M010	348
130039-0125	DND101	265	130039-0547	DNDF49A-M010	270	130050-0429	ENS3135M010	348
130039-0127	DND40-M010	269	130039-0548	DNDF42A-M010	270	130050-0436	ENS3305M010	344
130039-0132	DND41A-M010	270	130039-0549	DNDF43A-M010	270	130050-0457	ENP3335M010	345
130039-0145	DND12A-M010	260	130039-0551	DNDF93A-M010	260	130050-0503	ENS3335M010	345
130039-0151	DND13A-M010	260	130047-0017	E1A500-52	364	130050-0506	ENQ3105M010	347
130039-0157	DND21A-M010	259	130047-0018	E1A506-52	364	130050-0507	ENQ3335M010	345
130039-0175	DND29A-M010	259	130048-0031	E66A06003M010	346	130050-0512	ENV3335M010	345
130039-0179	DND31A-M010	259	130048-0038	E10A00603M010	360	130050-8023	ENV3105M010	347
130039-0188	DND39A-M010	259	130048-0046	E10A00610M010	360	130050-8025	ENV3115M010	348
130039-0190	DND42A-M010	270	130048-0054	E10A00615M010	360	130050-8029	ENV3135M010	348
130039-0204	DND43A-M010	270	130048-0062	E10A00703M010	360	130050-8036	ENP3135M010	348
130039-0209	DND92A-M010	260	130048-0070	E10A00710M010	360	130053-0002	ENDR2FB5	349
130039-0216	DND93A-M010	260	130048-0078	E10A00715M010	360	130053-0004	ENPR1FF5	350
130039-0223	DNDC220A-M005	261	130048-0088	E11A06003M010	361	130054-0009	ERTPADAPTER	371

Order No. Index

<i>Order No.</i>	<i>Engineering No.</i>	<i>Page</i>	<i>Order No.</i>	<i>Engineering No.</i>	<i>Page</i>	<i>Order No.</i>	<i>Engineering No.</i>	<i>Page</i>
130054-0010	ERTPADAPTER90	371	130063-0169	C04007A48M020	206	130070-0019	55-0298	217
130054-0012	ERWAAJ4002M002	369	130063-0181	C04100A48M020	205	130070-0020	66200A-10	217
130054-0013	ERWAAJ4002M020	369	130063-0183	C04101A48M020	205	130070-0021	CA3000-39	211
130055-0001	ENSP1F5	352	130063-0189	C04107A48M020	206	130070-0022	CA3006-39	211
130055-0005	ENSP1F5M010	352	130063-0194	C03007A48M020	206	130070-0023	CA4000-39	211
130055-0014	ENSP6F5	352	130063-0199	C03101A48M020	205	130070-0024	CA4006-39	211
130055-0016	ENSR1FB5	351	130063-0200	C03106A48M020	206	130188-0033	67-0065	246
130055-0020	ENSR1FB5M010	351	130063-0201	C03107A48M020	206	130188-0034	67-0075	246
130057-0001	ENQAM315	354	130064-0065	CC3030A48M020	207	130201-1109	65-0085	153, 217
130057-0003	ENSAM315	354	130064-0187	CC4030A48M020	207	130201-1111	65-0086	153, 217
130058-0033	65-0300	354	130064-0356	CC4130A48M020	207	130201-1115	65-0102	163
130058-0034	65-0301	354	130064-0401	CC3130A48M020	207	130201-1116	65-0103	163
130058-0035	67-0300	354	130066-0035	1R3000A28M005G	215	130201-1118	65-0104	171
130058-0036	67-0301	354	130066-0050	1R3006A28M005G	215	130201-1120	65-0105	171
130058-0057	RJBG16821	353, 353	130066-0069	1R4000A28M005G	215	130201-1224	55-0426	153
130060-0001	409P401	154	130066-0078	1R4006A20M005G	215	130201-1226	55-0466	163
130060-0002	409P403	156	130066-0090	1R4006A28M005G	215	130201-1228	55-0496	171
130060-0012	409P601	154	130066-0110	CR3000A30M005	210	130211-0032	85-0001	303
130060-0017	409P801	154	130066-0134	CR3C00A30M005	210	860000-0141	SDK-EIP-EDS	333
130060-0023	410P401	155	130066-0143	CR3C06A30M005	210	860000-0142	SDK-PFN-EDS	332
130060-0024	410P601	155	130066-0152	CR4000A30M005	210	860000-0143	SDK-EIP-TRN	333
130060-0026	410P801	155	130066-0170	CR4006A30M005	210	860000-0144	SDK-PFN-TRN	332
130060-0065	DNAUX4000	157	130066-0186	CR4106A30M005	210			
130060-0066	DNAUX8000	157	130066-0189	CR4C00A30M005	210			
130060-0067	ACAUX4000	157	130066-0203	CR4C06A30M005	210			
130060-0068	ACAUX8000	157	130066-0254	1R4000A20M005G	215			
130061-0025	103000A45M020	212	130066-0255	CR3006A30M005	210			
130061-0030	103000A46M020	212	130066-0256	CR3100A30M005	210			
130061-0040	103001A46M020	212	130066-0257	CR3106A30M005	210			
130061-0046	103006A45M020	213	130066-0258	CR3D00A30M005	210			
130061-0057	103006A46M020	213	130066-0259	CR3D06A30M005	210			
130061-0073	103007A46M020	213	130066-0260	CR4100A30M005	210			
130061-0080	104000A45M020	212	130066-0261	CR4D00A30M005	210			
130061-0091	104000A46M020	212	130066-0262	CR4D06A30M005	210			
130061-0108	104001A45M020	212	130066-0263	1R3006A20M005G	215			
130061-0119	104001A46M020	212	130066-0281	1R3000A20M005G	215			
130061-0135	104006A45M020	213	130068-0015	1C3030-001	209			
130061-0150	104006A46M020	213	130068-0017	1C3130-001	209			
130061-0168	104007A45M020	213	130068-0019	1C4030-001	209			
130061-0179	104007A46M020	213	130068-0022	1C4130-001	209			
130061-0218	103007A45M020	213	130068-0034	TC30130-200	208			
130061-0220	103001A45M020	212	130068-0039	TC30200A45M010	208			
130062-0032	113030A45M020	214	130068-0042	TC30200A46M010	208			
130062-0047	113030A46M020	214	130068-0045	TC30C30-200	208			
130062-0088	114030A45M020	214	130068-0051	TC31130-200	208			
130062-0124	114030A46M020	214	130068-0055	TC31C31-200	208			
130063-0003	C03000A48M020	205	130068-0069	TC40140-200	208			
130063-0012	C04106A48M020	206	130068-0072	TC40200A45M010	208			
130063-0037	C03001A48M020	205	130068-0075	TC40200A46M010	208			
130063-0042	C03006A48M020	206	130068-0079	TC40C40-200	208			
130063-0056	C03100A48M020	205	130068-0082	TC41140-200	208			
130063-0089	C04000A48M020	205	130068-0086	TC41C41-200	208			
130063-0135	C04001A48M020	205	130070-0012	11400A-10	217			
130063-0150	C04006A48M020	206	130070-0018	55-0198	217			

Engineering No. Index

<i>Engineering No.</i>	<i>Order No.</i>	<i>Page</i>	<i>Engineering No.</i>	<i>Order No.</i>	<i>Page</i>	<i>Engineering No.</i>	<i>Order No.</i>	<i>Page</i>
0812-051FJ-00000	120068-8009	52, 114	113020A01F060	130010-0221	142	1A4002-34	130017-0018	150
0812-05EMF-00000	120068-0139	52, 114	113020C01F060	130010-0307	142	1A4006-34	130017-0020	150, 280
0812-05EMF-00001	120068-0137	52, 114	113030A45M020	130062-0032	214	1A4006-34PWR	130017-0058	216
102000A01F060	130006-0091	138	113030A46M020	130062-0047	214	1A5000-34	130017-0023	150, 321
102001A01F060	130006-0137	138	113030K13M020	130010-0488	143, 157	1A5000-34DN	130034-0005	248
102002A01F060	130006-0159	141	11400A-10	130070-0012	217	1A5002-34	130017-0026	150
103000A01F060	130006-0221	138	114020A01F060	130010-0525	142	1A5006-34	130017-0029	150, 321
103000A01F120	130006-0232	156	114030A38M020	130010-0795	143, 278	1A5006-34DN	130034-0006	248
103000A02F060	130006-0279	138	114030A45M020	130062-0088	214	1C3030-001	130068-0015	209
103000A03F060	130006-0302	138	114030A46M020	130062-0124	214	1C3130-001	130068-0017	209
103000A06M020	130006-0339	138	114030K12M020	130010-0865	143, 157, 278	1C4030-001	130068-0019	209
103000A45M020	130061-0025	212	114033A38M020	130010-1823	278	1C4130-001	130068-0022	209
103000A46M020	130061-0030	212	114033K12M020	130010-1744	278	1R2004A20A120	130013-0060	145
103000C01F060	130006-0377	138	115010A	130039-0351	253	1R2005A20A120	130013-0074	145
103001A01F060	130006-0426	138	115011A-PM-1	130035-0007	251	1R2006A20A120	130013-0076	146
103001A02F060	130006-0452	138	115011A-PM-3	130035-0008	251	1R2007A20A120	130013-0090	146
103001A45M020	130061-0220	212	115020A01F060	130010-1005	142	1R2G04A20A120	130013-0093	145
103001A46M020	130061-0040	212	115030A01M020	130010-1256	319	1R2G06A20A120	130013-0099	146
103002A01F060	130006-0534	141	115030K13M020	130010-0103	143, 319	1R3000A20M005G	130066-0281	215
103003A01F060	130006-0647	141	115032A	130035-0013	253	1R3000A20M020	130013-0112	144
103006A45M020	130061-0046	213	115033A01M020	130010-1303	319	1R3000A28M005G	130066-0035	215
103006A46M020	130061-0057	213	115033K13M020	130010-0119	319	1R3004A20A120	130013-0135	145
103007A45M020	130061-0218	213	115060A	130035-0015	253	1R3005A20A120	130013-0184	145
103007A46M020	130061-0073	213	116020A01F060	130010-1316	142	1R3006A17A120	130013-0193	146
104000A01F060	130006-0728	139	1202440002	120244-0002	372	1R3006A20A120	130013-0202	146
104000A03F060	130006-0813	139	1202440201	120244-0201	372	1R3006A20M005G	130066-0263	215
104000A05M020	130006-0833	139	1202440202	120244-0202	372	1R3006A24A120	130013-0229	146
104000A45M020	130061-0080	212	1202440203	120244-0203	372	1R3006A25A120	130013-0238	147
104000A46M020	130061-0091	212	1202440204	120244-0204	372	1R3006A28M005G	130066-0050	215
104000C01F060	130006-0868	139	1202440205	120244-0205	372	1R3007A20A120	130013-0247	146
104001A01F060	130006-0902	139	1202440207	120244-0207	372	1R3D06A25A120	130013-0268	147
104001A45M020	130061-0108	212	1203410075	120341-0075	373	1R3G04A20A120	130013-0273	145
104001A46M020	130061-0119	212	1203410150	120341-0150	373	1R3G06A20A120	130013-0280	146
104002A01F060	130006-0995	141	1203410300	120341-0300	374	1R4000A20M005G	130066-0254	215
104003A01F060	130006-1087	141	1203410301	120341-0301	374	1R4000A28M005G	130066-0069	215
104006A45M020	130061-0135	213	1203410302	120341-0302	374	1R4000A39M020	130013-0301	144
104006A46M020	130061-0150	213	1203410303	120341-0303	374	1R4004A20A120	130013-0314	145
104007A45M020	130061-0168	213	1203410304	120341-0304	374	1R4005A20A120	130013-0337	145
104007A46M020	130061-0179	213	1203410305	120341-0305	374	1R4006A16A120	130013-0341	147
105000A01F060	130006-1163	139	1203410306	120341-0306	374	1R4006A20A120	130013-0353	147
105000A02F060	130006-1240	140	1203550014	120355-0014	372	1R4006A20M005G	130066-0078	215
105000A03F060	130006-1257	140	1203550015	120355-0015	372	1R4006A28M005G	130066-0090	215
105000A07M020	130006-1275	140	1203550016	120355-0016	372	1R4007A20A120	130013-0386	147
105000C01F060	130006-1312	140	1203550017	120355-0017	372	1R4030	130013-0388	149, 279
105001A01F060	130006-1349	139	1203550018	120355-0018	372	1R40301	130013-1001	279
105001A02F060	130006-1382	140	1203550020	120355-0020	372	1R4D06A16A120	130013-0396	147
105001A07M020	130006-1404	140	1203550056	120355-0056	372	1R4G04A20A120	130013-0402	145
105002A01F060	130006-1438	141	1A3000-34	130017-0004	150	1R4G06A20A120	130013-0409	147
105003A01F060	130006-1518	141	1A3000-34PWR	130017-0055	216	1R5000A20F060	130013-0423	320
106000A01F060	130006-1583	140	1A3002-34	130017-0008	150	1R5000A20M020	130013-0426	144
106000A01F120	130006-1590	154	1A3006-34	130017-0011	150	1R5004A20A120	130013-0442	145
106001A01F060	130006-1653	140	1A3006-34PWR	130017-0056	216	1R5005A20A120	130013-0482	145
106002A01F060	130006-1675	141	1A4000-34	130017-0015	150, 280	1R5006A17A120	130013-0489	148
112020A01F060	130010-0147	142	1A4000-34PWR	130017-0057	216	1R5006A20A120	130013-0493	148

Engineering No. Index

<i>Engineering No.</i>	<i>Order No.</i>	<i>Page</i>	<i>Engineering No.</i>	<i>Order No.</i>	<i>Page</i>	<i>Engineering No.</i>	<i>Order No.</i>	<i>Page</i>
1R5006A24A120	130013-0515	148	3R1004A20A120	130015-0024	167	405006A10M020	120086-0206	71
1R5007A20A120	130013-0534	148	3R1006A20A120	130015-0044	168	405006B09M020	120086-0387	71
1R5030	130013-0541	149, 247	3R2004A20A120	130015-0054	167	405006D12M010	130029-0003	273
1R5D06A25A120	130013-0548	148	3R2006A20A120	130015-0076	168	405006E02M020	120086-8173	127
1R5G04A20A120	130013-0550	145	3R3N30E80C300	130015-0098	170	405006P02M020	120027-0752	127
1R5G06A20A120	130013-0557	148	3R3N36E80C300	130015-0109	170	405007A10M020	120086-0210	71
1R6004A20A120	130013-0567	145	3R9004A20A120	130015-0117	167	405007B09M020	120086-0390	71
1R6005A20A120	130013-0589	145	3R9006A20A120	130015-0137	168	405007D12M010	130029-0005	273
1R6006A20A120	130013-0593	148	403000A10M020	120086-0102	70	405007E02M020	120086-8083	127
1R6007A20A120	130013-0612	148	403000B09M020	120086-0336	70	405007P02M020	120086-8061	127
1R6G04A20A120	130013-0614	145	403000E02M020	120027-0066	126	40761	130018-0204	153
1R6G06A20A120	130013-0620	148	403000P02M020	120086-8001	126	40925	130006-2099	151
206000A01F060	130007-0024	158	403001A10M020	120086-0119	70	409P401	130060-0001	154
206002A01F060	130007-0051	159	403001B09M020	120086-0022	70	409P403	130060-0002	156
207000A01F060	130007-0073	158	403001E02M020	120027-0090	126	409P601	130060-0012	154
207000A01F120	130007-0076	155	403001P02M020	120086-8155	126	409P801	130060-0017	154
207002A01F060	130007-0115	159	403006A10M020	120086-0132	71	41037	130006-2102	151
208000A01F060	130007-0142	158	403006B09M020	120086-0027	71	41048	130018-0206	153
208000A01F120	130007-0145	154	403006E02M020	120086-8228	127	410P401	130060-0023	155
208002A01F060	130007-0199	159	403006P02M020	120027-0911	127	410P601	130060-0024	155
226020A01F060	130011-0010	160	403007A10M020	120086-0139	71	410P801	130060-0026	155
227020A01F060	130011-0051	160	403007B09M020	120086-0033	71	41132	130006-2103	151
228020A01F060	130011-0119	160	403007E02M020	120027-0106	127	41212	130018-0207	153
2R6004A20A120	130014-0015	161	403007P02M020	120086-8329	127	41344	130006-2107	151
2R6006A20A120	130014-0025	162	4030P1A10M020	120086-0421	70	41437-001	130039-0358	219
2R7004A20A120	130014-0037	161	4030P1B09M020	120086-0009	70	41437-002	130039-0359	219
2R7006A20A120	130014-0050	162	4030P1E02M020	120027-0115	126	41481	130018-0210	153
2R8004A20A120	130014-0061	161	4030P1P02M020	120086-8337	126	41593	130006-2109	151
2R8006A20A120	130014-0078	162	404000A10M020	120086-0144	70	41627-M010	130010-1657	218
301000A01F060	130008-0025	164	404000B09M020	120086-0171	70	41671-0030	130013-0991	219
301000A01F120	130008-0028	154	404000E02M020	120027-0127	126	443030A10M010	120087-0074	72
301001A01F060	130008-0098	164	404000P02M020	120086-8156	126	443030E02M010	120087-8258	128
301002A01F060	130008-0117	165	404001A10M020	120086-0175	70	443030P02M010	120087-8140	128
302000A01F060	130008-0157	164	404001B09M020	120086-0042	70	443031A10M010	120087-0243	72
302000A01F120	130008-0161	155	404001E02M020	120027-0152	126	443031E02M010	120028-0016	128
302001A01F060	130008-0212	164	404001P02M020	120086-8159	126	443031P02M010	120087-8316	128
302002A01F060	130008-0231	165	404006A10M020	120086-0183	71	443032A10M010	120087-0253	72
302101P80M100	130008-0476	29, 54, 91, 116	404006B09M020	120086-0048	71	443032E02M010	120087-8321	128
302201P80M100	130008-8006	29, 54, 91, 116	404006E02M020	120086-8368	127	443032P02M010	120087-8324	128
302301P80M100	130008-8009	29, 54, 91, 116	404006P02M020	120086-8373	127	443033A10M010	120087-0088	72
303000P80M050	130008-0303	169	404007A10M020	120086-0186	71	443033E02M010	120087-8329	128
303001P80M050	130008-0315	169	404007B09M020	120086-0052	71	443033P02M010	120087-8502	128
303001P80M100	130008-0316	30, 56, 92, 117	404007E02M020	120027-0483	127	444030A10M010	120087-0093	72
303201P80M100	130008-5006	30, 56, 92, 117	404007P02M020	120086-8382	127	444030E02M010	120087-8349	128
309000A01F060	130008-0325	164	405000A10M020	120086-0191	70	444030P02M010	120087-8359	128
309000A01F120	130008-0329	155	405000B09M020	120086-0196	70	444031A10M010	120087-0103	72
309001A01F060	130008-0351	164	405000D12M010	130029-0001	272	444031E02M010	120087-8365	128
309002A01F060	130008-0366	165	405000E02M020	120086-8099	126	444031P02M010	120087-8372	128
331020A01F060	130012-0009	166	405000P02M020	120027-0709	126	444032A10M010	120087-0281	72
332020A01F060	130012-0113	166	405001A10M020	120086-0200	70	444032E02M010	120087-8503	128
333030P80M050	130012-0339	169	405001B09M020	120086-0386	70	444032P02M010	120087-8504	128
339020A01F060	130012-0385	166	405001D12M010	130029-0002	272	444033A10M010	120087-0108	72
			405001E02M020	120086-8178	126	444033E02M010	120087-8507	128
			405001P02M020	120086-8391	126	444033P02M010	120087-8380	128

Engineering No. Index

<i>Engineering No.</i>	<i>Order No.</i>	<i>Page</i>	<i>Engineering No.</i>	<i>Order No.</i>	<i>Page</i>	<i>Engineering No.</i>	<i>Order No.</i>	<i>Page</i>
444A30	120089-5002	78	504001A10M020	120088-0054	79	705000D02F060	120072-0471	62
445030A10M010	120087-0112	72	504001B09M020	120088-0130	79	705001A03F060	120072-0508	62
445030D12M010	130030-0003	274	504001E02M020	120088-8124	135	705001D02F060	120072-0515	62
445031A10M010	120087-0287	72	504001H08M020	120088-8126	135	705006A03F060	120072-0546	63
445031D12M010	130030-0088	274	504001P02M020	120088-8125	135	705006D02F060	120072-0551	63
445032A10M010	120087-0290	72	504006A10M020	120088-0059	79	705007A03F060	120072-1010	63
445032D12M010	130030-0004	274	504006B09M020	120088-0014	79	705007D02F060	120072-0558	63
445033A10M010	120087-0117	72	504006E02M020	120088-8120	135	706000D02F060	120072-0568	62
445033D12M010	130030-0089	274	504006H08M020	120088-8127	135	706001D02F060	120072-0595	62
485030D12M010	130030-0010	276	504006P02M020	120088-8131	135	706006D02F060	120072-0616	63
485031D12M010	130030-0090	276	51149	130018-0184	151	706007D02F060	120072-0626	63
485032D12M010	130030-0091	276	51180-M020	130018-0125	218	772030D02F030	120073-0057	64
485033D12M010	130030-0022	276	55-0198	130070-0018	217	772031D02F030	120073-5009	64
4R3F06E02C3003	120031-0004	130	55-0298	130070-0019	217	772032D02F030	120073-5010	65
4R3F30E02C3003	120031-0015	129	55-0426	130201-1224	153	772033D02F030	120073-0068	65
4R3H400013	120090-5001	73	55-0466	130201-1226	163	773030A03F030	120073-0085	64
4R3H40E02C3003	120031-0046	73, 129	55-0496	130201-1228	171	773030D02F030	120073-0100	64
4R3L40001	120149-0016	129	61056	130018-0217	152	773031A03F030	120073-0140	64
4R3P00A27C300	120090-0016	73	61451-ESIN	130035-0030	218	773031D02F030	120073-0151	64
4R3P06A27C300	120090-0020	74	61451-ESOUT	130035-0031	218	773032A03F030	120073-0172	65
4R4F06E02C3003	120031-0006	130	65-0085	130201-1109	153, 217	773032D02F030	120073-0178	65
4R4F30E02C3003	120031-0049	129	65-0086	130201-1111	153, 217	773033A03F030	120073-0185	65
4R4H400013	120031-0118	73	65-0102	130201-1115	163	773033D02F030	120073-0190	65
4R4H40E02C3003	120031-0022	73, 129	65-0103	130201-1116	163	774030A03F030	120073-0391	64
4R4L40001	120149-0064	129	65-0104	130201-1118	171	774030D02F030	120073-0215	64
4R4P00A27C300	120090-0029	73	65-0105	130201-1120	171	774031A03F030	120073-0237	64
4R4P06A27C300	120090-0032	74	65-0300	130058-0033	354	774031D02F030	120073-0241	64
4R5F06E02C3003	120031-0027	130	65-0301	130058-0034	354	774032A03F030	120073-0246	65
4R5F30E02C3003	120031-0028	129	66200A-10	130070-0020	217	774032D02F030	120073-0250	65
4R5H40E02C3003	120031-0050	73, 129	67-0065	130188-0033	246	774033A03F030	120073-0390	65
4R5L40001	120149-0095	129	67-0075	130188-0034	246	774033D02F030	120073-5011	65
4R5P00A27C300	120090-0037	73	67-0300	130058-0035	354	775030A03F030	120073-0272	64
4R5P06A27C300	120090-0038	74	67-0301	130058-0036	354	775030D02F030	120073-0293	64
503000A10M020	120088-0022	79	702000D02F060	120072-0061	62	775031A03F030	120073-5012	64
503000B09M020	120088-0002	79	702001D02F060	120072-0085	62	775031D02F030	120073-0335	64
503000E02M020	120088-8001	135	702006D02F060	120072-0108	63	775032A03F030	120073-0346	65
503000H08M020	120088-8122	135	702007D02F060	120072-0118	63	775032D02F030	120073-5013	65
503000P02M020	120088-8083	135	703000A03F060	120072-0130	62	775033A03F030	120073-0351	65
503001A10M020	120088-0032	79	703000D02F060	120072-0171	62	775033D02F030	120073-0354	65
503001B09M020	120088-0040	79	703001A03F060	120072-0219	62	776030D02F030	120073-0357	64
503001E02M020	120088-8086	135	703001D02F060	120072-0250	62	776031D02F030	120073-0376	64
503001H08M020	120088-8128	135	703006A03F060	120072-0292	63	776032D02F030	120073-0577	65
503001P02M020	120088-8090	135	703006D02F060	120072-0302	63	776033D02F030	120073-5014	65
503006A10M020	120088-0042	79	703007A03F060	120072-0315	63	7A3000-31	120075-0014	68
503006B09M020	120088-0112	79	703007D02F060	120072-0318	63	7A3000-32	120075-0015	68
503006E02M020	120088-8093	135	704000A03F060	120072-0334	62	7A3001-31	120075-0016	68
503006H08M020	120088-8129	135	704000D02F060	120072-0356	62	7A3006-31	120075-0017	68
503006P02M020	120088-8130	135	704001A03F060	120072-0387	62	7A3006-32	120075-0018	68
5030P1A10M020	120088-0099	79	704001D02F060	120072-0402	62	7A3007-31	120075-0019	68
5030P1B09M020	120088-0001	79	704006A03F060	120072-0435	63	7R2006A19A120	120074-0042	67
504000B09M020	120088-0116	79	704006D02F060	120072-0445	63	7R2A00A19A120	120074-0014	66
504000E02M020	120088-8095	135	704007A03F060	120072-5019	63	7R2A06A19A120	120074-0030	67
504000H08M020	120088-8121	135	704007D02F060	120072-1022	63	7R3006A19A120	120074-0106	67
504000P02M020	120088-8123	135	705000A03F060	120072-0459	62	7R3A00A19A120	120074-0058	66

Engineering No. Index

<i>Engineering No.</i>	<i>Order No.</i>	<i>Page</i>	<i>Engineering No.</i>	<i>Order No.</i>	<i>Page</i>	<i>Engineering No.</i>	<i>Order No.</i>	<i>Page</i>
7R3A06A19A120	120074-0079	67	804007A09M020	120065-1662	40	845031D12M010	130030-0041	275
7R4006A19A120	120074-0160	67	804007E03M020	120006-1975	102	845032D12M010	130030-0061	275
7R4A00A19A120	120074-0122	66	804007H09M020	120065-8736	102	845033D12M010	130030-0070	275
7R4A06A19A120	120074-0140	67	804007K05M020	120065-1691	40, 102	848549317	84854-9317	391
7R5006A19A120	120074-0222	67	804007P03M020	120006-0592	102	848549318	84854-9318	391
7R5A00A19A120	120074-0178	66	8040P0A09M020	120067-0027	46	85-0001	130211-0032	303
7R5A06A19A120	120074-0190	67	8040P0B03M020	120067-5229	46	883030A09M010	120066-0166	42
803000A09M020	120065-0129	38	8040P0E03M020	120067-5094	108	883030E03M010	120007-0083	104
803000E03M020	120006-0001	100	8040P0H09M020	120067-8327	108	883030H09M010	120066-8374	104
803000H09M020	120065-8175	100	8040P0K05M020	120067-5230	46, 108	883030K05M010	120066-0676	42, 104
803000K05M020	120065-1108	38, 100	8040P0P03M020	120067-5063	108	883030P03M010	120066-0498	104
803000P03M020	120006-0004	100	8040P1A09M020	120067-0257	46	883031A09M010	120066-1137	42
803001A09M020	120065-1444	38	8040P1B03M020	120067-5231	46	883031E03M010	120007-0119	104
803001E03M020	120006-0007	100	8040P1E03M020	120067-5014	108	883031H09M010	120065-8763	104
803001H09M020	120065-8715	100	8040P1H09M020	120067-8309	108	883031K05M010	120066-0222	42, 104
803001K05M020	120065-1489	38, 100	8040P1K05M020	120067-5232	46, 108	883031P03M010	120007-0142	104
803001P03M020	120006-0011	100	8040P1P03M020	120006-0618	108	883032A09M010	120066-1177	44
803006A09M020	120065-0200	40	805000A09M020	120065-0471	38, 283, 323	883032E03M010	120007-0160	106
803006E03M020	120006-0240	102	805000E03M020	120006-0634	100, 325	883032H09M010	120007-2879	106
803006H09M020	120065-8655	102	805000H09M020	120065-8172	100	883032K05M010	120066-0231	44, 106
803006K05M020	120065-1114	40, 102	805000K03M020	120065-1367	283, 323, 325	883032P03M010	120007-0172	106
803006P03M020	120006-0257	102	805000P03M020	120006-0647	100	883033A09M010	120066-1199	44
803007A09M020	120065-1497	40	805001A09M020	120065-1697	38, 283, 323	883033E03M010	120066-5399	106
803007E03M020	120006-0273	102	805001E03M020	120006-0652	100, 325	883033H09M010	120066-8498	106
803007H09M020	120065-8722	102	805001H09M020	120065-8296	100	883033K05M010	120066-1223	44, 106
803007K05M020	120065-1501	40, 102	805001K03M020	120065-1720	283, 323, 325	883033P03M010	120007-0216	106
803007P03M020	120006-0288	102	805001P03M020	120006-0663	100	8830P6A09M010	120067-0037	47
8030P0A09M020	120067-0185	46	805006A09M020	120065-0523	40	8830P6B03M010	120067-5233	47
8030P0B03M020	120067-0192	46	805006E03M020	120006-0667	102	8830P6E03M010	120067-8064	109
8030P0E03M020	120067-5227	108	805006H09M020	120065-8743	102	8830P6H09M010	120067-8331	109
8030P0H09M020	120067-8328	108	805006P03M020	120006-0680	102	8830P6K05M010	120067-0040	47, 109
8030P0K05M020	120067-5228	46, 108	805007A09M020	120065-1724	40	8830P7A09M010	120067-0046	47
8030P0P03M020	120067-5008	108	805007E03M020	120065-8096	102	8830P7B03M010	120067-0058	47
8030P1A09M020	120067-0227	46	805007H09M020	120065-8750	102	8830P7E03M010	120067-8068	109
8030P1B03M020	120067-0241	46	805007P03M020	120006-0697	102	8830P7H09M010	120067-8295	109
8030P1E03M020	120067-5067	108	808000H08M020	120065-8644	101	8830P7K05M010	120067-0065	47, 109
8030P1H09M020	120067-8308	108	808000P02M020	120065-0951	39, 101	8830P7P03M010	120067-5078	109
8030P1K05M020	120067-0198	46, 108	808001H08M020	120065-8649	101	8830P8A09M010	120067-5235	48
8030P1P03M020	120067-5069	108	808001P02M020	120065-0960	39, 101	8830P8B03M010	120067-5236	48
804000A09M020	120065-0255	38	808006H08M020	120065-8660	103	8830P8E03M010	120067-5237	110
804000E03M020	120006-0014	100	808006P02M020	120065-0964	41, 103	8830P8H09M010	120067-8334	110
804000H09M020	120065-8178	100	808007H08M020	120065-8757	103	8830P8K05M010	120067-0072	48, 110
804000K05M020	120065-1121	38, 100	808007P02M020	120065-1800	41, 103	8830P8P03M010	120067-5238	110
804000P03M020	120006-0018	100	80C000H45M020	120065-5040	39, 101	8830P9A09M010	120067-0074	48
804001A09M020	120065-1551	38	80C001H45M020	120065-5099	39, 101	8830P9B03M010	120067-5239	48
804001E03M020	120006-0021	100	80C006H45M020	120065-5045	41, 103	8830P9E03M010	120067-5088	110
804001H09M020	120065-8513	100	80C007H45M020	120065-5109	41, 103	8830P9H09M010	120067-8329	110
804001K05M020	120065-1639	38, 100	81590R	120068-0169	52, 114	8830P9K05M010	120067-0079	48, 110
804001P03M020	120006-0024	100	81594R	120068-0170	52, 114	8830P9P03M010	120067-8087	110
804006A09M020	120065-0414	40	81611	130031-0023	262	884030A09M010	120066-0266	42
804006E03M020	120006-0560	102	81612	130031-0026	262	884030E03M010	120007-0473	104
804006H09M020	120065-8729	102	81688-030	120099-0025	308	884030H09M010	120066-8379	104
804006K05M020	120065-1129	40, 102	81689-030	120099-0024	308	884030K05M010	120066-0687	42, 104
804006P03M020	120006-0570	102	845030D12M010	130030-0027	275	884030P03M010	120007-0488	104

Engineering No. Index

<i>Engineering No.</i>	<i>Order No.</i>	<i>Page</i>	<i>Engineering No.</i>	<i>Order No.</i>	<i>Page</i>	<i>Engineering No.</i>	<i>Order No.</i>	<i>Page</i>
884031A09M010	120066-1262	42	885031A09M010	120066-1389	42	8R4J460003	120011-0281	50, 112
884031E03M010	120007-0509	104	885031E03M010	120066-8189	104	8R5000A18A120	120070-5206	49
884031H09M010	120066-8484	104	885031H09M010	120066-8496	104	8R5006A18A120	120070-0252	50
884031K05M010	120066-0376	42, 104	885031P03M010	120066-8188	104	8R5A00A18A120	120070-0201	49, 285, 327
884031P03M010	120006-0056	104	885032A09M010	120066-1399	44	8R5J20E03C3003	120070-5207	111, 328
884032A09M010	120066-1307	44	885032E03M010	120007-1271	106	8R5J26E03C3003	120011-0036	112
884032E03M010	120066-8073	106	885032H09M010	120066-8493	106	8R5J400013	120011-0238	49, 111
884032H09M010	120066-8494	106	885032P03M010	120066-5401	106	8R5J460003	120070-0235	50, 112
884032K05M010	120066-0400	44, 106	885033A09M010	120066-1634	44, 284, 324	8R5L30	120070-0237	263, 285, 327, 328
884032P03M010	120007-1407	106	885033E03M010	120066-5402	106, 326			
884033A09M010	120066-1336	44	885033H09M010	120066-8499	106	8R8J20E02C3003	120070-5208	49, 111
884033E03M010	120007-0554	106	885033K03M010	120066-1421	284, 324	8R8J26E02C3003	120070-5209	50, 112
884033H09M010	120066-8492	106	885033P03M010	120066-8094	106	8R8J400013	120070-5210	49, 111
884033K05M010	120066-1382	44, 106	888030H08M010	120066-8491	105	8R8J460003	120070-5180	50, 112
884033P03M010	120007-1523	106	888030P02M010	120066-0579	43, 105	8W4A30A09M003	120080-0033	28
8840P6A09M010	120067-0095	47	888031H08M010	120065-8909	105	8W4A30E03M003	120080-5092	90
8840P6B03M010	120067-5240	47	888031P02M010	120066-1626	43, 105	8W4A30H09M003	120082-8004	90
8840P6E03M010	120067-5241	109	888032H08M010	120066-8495	107	8W4A30K05M003	120080-0108	28, 90
8840P6H09M010	120067-8333	109	888032P02M010	120066-5403	45, 107	8W4A30P03M003	120080-5093	90
8840P6K05M010	120067-0101	47, 109	888033H08M010	120065-8908	107	8W4A31A09M003	120080-0037	28
8840P6P03M010	120067-8255	109	888033P02M010	120066-0479	45, 107	8W4A31E03M003	120080-5094	90
8840P7A09M010	120067-0107	47	88C030H45M010	120066-5404	43, 105	8W4A31H09M003	120080-8024	90
8840P7B03M010	120067-0112	47	88C031H45M010	120066-5405	43, 105	8W4A31K05M003	120080-0116	28, 90
8840P7E03M010	120067-5090	109	88C032H45M010	120066-5406	45, 107	8W4A31P03M003	120080-5095	90
8840P7H09M010	120067-8332	109	88C033H45M010	120066-5407	45, 107	ACAUX4000	130060-0067	157
8840P7K05M010	120067-0117	47, 109	8A4000-31	120071-0035	51, 113	ACAUX8000	130060-0068	157
8840P7P03M010	120067-5040	109	8A4000-32	120071-0036	51, 113	APP-EPB-PCIE	112000-5028	292, 336
8840P8A09M010	120067-5242	48	8A4001-31	120071-0037	51, 113	APP-EPB-PCU-C	112000-0001	292, 336
8840P8B03M010	120067-5243	48	8A4006-31	120071-0038	51, 113	APP-ESR-PCIE	112000-5027	336, 381
8840P8E03M010	120067-5244	110	8A4006-32	120071-0039	51, 113	APP-ESR-PCU-C	112000-0003	336, 381
8840P8H09M010	120067-8335	110	8A4007-31	120071-0040	51, 113	APP-ETH-PCIE	112000-5026	336
8840P8K05M010	120067-0122	48, 110	8A5000-31	120071-0041	51, 113	APP-ETH-PCU-C	112000-0005	336
8840P8P03M010	120067-5245	110	8A5000-32	120071-0043	51, 113, 286, 329	APP-PFB-PCIE	112011-5026	292
8840P9A09M010	120067-5246	48				APP-PFB-PCU-C	112011-0004	292
8840P9B03M010	120067-5247	48	8A5000-32DN	130034-0007	264	APP-PS7-PCIE	112011-5027	292
8840P9E03M010	120067-5248	110	8A5001-31	120071-0044	51, 113	APP-PS7-PCU-C	112011-0006	292
8840P9H09M010	120067-8330	110	8A5006-31	120071-0045	51, 113	APP-SR1-PCIE	112020-5018	381
8840P9K05M010	120067-5249	48, 110	8A5006-32	120071-0047	51, 113, 286, 329	APP-SR1-PCU-C	112020-5017	381
8840P9P03M010	120067-8211	110				B05500PP4M010	120098-0084	304
884A30A09M003	120068-0175	53	8A5006-32DN	130034-0008	264	B05501PP4M010	120039-0132	304
884A30E03M003	120068-8096	115	8A5007-31	120071-0049	51, 113	B05506	120102-0002	311
884A30H09M003	120068-8138	115	8R3000A18A120	120070-5200	49	B05506PP4M010	120098-0099	305
884A30K05M003	120068-0195	53, 115	8R3006A18A120	120070-0093	50	B05507PP4M010	120039-0158	305
884A30P03M003	120009-0091	115	8R3A00A18A120	120070-0056	49	B152000N2	121012-0009	191
884A31A09M003	120068-0199	53	8R3J20E03C3003	120070-5201	111	B153000N2	121012-0010	191
884A31E03M003	120068-5031	115	8R3J26E03C3003	120070-5202	112	B202000N2	121012-0013	188
884A31H09M003	120068-8137	115	8R3J400013	120070-5203	49, 111	B203000N2	121012-0019	188
884A31K05M003	120068-0211	53, 115	8R3J460003	120070-5204	50, 112	B292000N2	121012-0102	192
884APO	120068-5035	52, 114	8R4000A18A120	120070-0173	49	BA5500-32	120100-0001	310
885030A09M010	120066-0427	42, 284, 324	8R4006A18A120	120070-0184	50	BA5506-32	120100-0002	310
885030E03M010	120007-0906	104, 326	8R4A00A18A120	120070-0114	49	BB5S30PP4M010	120098-0006	306
885030H09M010	120066-8497	104	8R4J20E03C3003	120070-5205	111	BB5S31PP4M010	120098-5021	306
885030K03M010	120066-1034	284, 324, 326	8R4J26E03C3003	120011-0019	112	BB5S32PP4M010	120098-0024	306
885030P03M010	120066-8084	104	8R4J400013	120011-0237	49, 111	BB5S33PP4M010	120098-0029	306

Engineering No. Index

<i>Engineering No.</i>	<i>Order No.</i>	<i>Page</i>	<i>Engineering No.</i>	<i>Order No.</i>	<i>Page</i>	<i>Engineering No.</i>	<i>Order No.</i>	<i>Page</i>
BEY401P-FBP-05	120113-0006	77, 133	BNY603P-FBP-05	120054-0044	78, 134	BTY803P-FBB	120114-0083	56, 117
BEY403P-FBP-05	120054-0034	78, 134	BNY801P-FBC	120113-0029	76, 132	BTY803P-FBC	120114-0084	57, 119
BEY601P-FBP-05	120113-0011	77, 133	BNY801P-FBP-05	120113-0032	77, 133	BTY8050-FBP-05	120114-0092	60, 122
BEY603P-FBP-05	120054-0043	78, 134	BNY803P-FBP-05	120054-0004	78, 134	BTY805N-FBP-05	120114-0202	60, 122
BEY801P-FBP-05	120113-0014	77, 133	BNYA01P-FBC	120113-0020	76, 132	BTY805P-FBP-05	120114-0089	60, 122
BEY803P-FBP-05	120113-0017	78, 134	BNYA01P-FBP-05	120113-0022	77, 133	BTY8120-FBP-050	120114-0099	61, 123
BEYA01P-FBP-05	120113-0002	77, 133	BNYA03P-FBP-05	120054-0046	78, 134	BTY812N-FBP-05	120114-0095	61, 123
BEYA03P-FBP-05	120054-0045	78, 134	BP5S32PP4M010	120098-0183	317	BTY812P-FBP-05	120114-0097	61, 123
BKY400P-FBP-05	120119-0001	34, 96	BP5S33PP4M010	120098-0077	317	C03000A48M020	130063-0003	205
BKY401P-FBB	120119-0002	29, 91	BP5S62PP4M010	120098-0079	317	C03001A48M020	130063-0037	205
BKY401P-FBC	120119-0003	31, 93	BP5S63PP4M010	120098-0181	317	C03006A48M020	130063-0042	206
BKY4030-FBC	120119-0038	32, 94	BR5L30	120099-0001	309	C03007A48M020	130063-0194	206
BKY403P-FBA	120119-0004	33, 95	BR5U70PP4M0103	120099-0005	307	C03100A48M020	130063-0056	205
BKY403P-FBB	120119-0005	30, 92	BR5U76PP4M0103	120099-0013	307	C03101A48M020	130063-0199	205
BKY403P-FBC	120119-0006	32, 94	BTY4000-FBP-05	120055-0586	59	C03106A48M020	130063-0200	206
BKY405P-FBP-05	120119-0007	35, 97	BTY400N-FBP-05	120114-8008	59, 121	C03107A48M020	130063-0201	206
BKY4120-FBP-01	120119-0008	36, 98	BTY400P-FBP-05	120114-8011	59, 121	C04000A48M020	130063-0089	205
BKY600P-FBP-05	120119-0009	34, 96	BTY4010-FBB	120114-0027	54, 116	C04001A48M020	130063-0135	205
BKY601P-FBB	120119-0010	29, 91	BTY4010-FBC	120055-0308	55, 118	C04006A48M020	130063-0150	206
BKY601P-FBC	120119-0011	31, 93	BTY401N-FBB	120114-0014	54, 116	C04007A48M020	130063-0169	206
BKY603P-FBA	120119-0012	33, 95	BTY401N-FBC	120114-0211	55, 118	C04100A48M020	130063-0181	205
BKY603P-FBB	120119-0013	30, 92	BTY401P-FBB	120114-0019	54, 116	C04101A48M020	130063-0183	205
BKY605P-FBP-05	120119-0015	35, 97	BTY401P-FBC	120114-0020	55, 118	C04106A48M020	130063-0012	206
BKY800P-FBP-05	120119-0016	34, 96	BTY4030-FBA	120114-0034	58, 120	C04107A48M020	130063-0189	206
BKY801P-FBB	120119-0017	29, 91	BTY4030-FBB	120114-0035	56, 117	C22200NOR	121202-0002	189
BKY801P-FBC	120119-0018	31, 93	BTY4030-FBC	120055-0313	57, 119	C25200NOT	121204-0001	191
BKY8030-FBC	120055-0925	32, 94	BTY403N-FBA	120055-0669	58, 120	C25300NOT	121204-0005	191
BKY803P-FBA	120119-0019	33, 95	BTY403P-FBA	120114-0029	58, 120	C28200NOR	121201-0001	188
BKY803P-FBB	120119-0020	30, 92	BTY403P-FBB	120114-0030	56, 117	C28300NOR	121201-0002	188
BKY803P-FBC	120119-0021	32, 94	BTY403P-FBC	120114-0031	57, 119	C29200NOT	121205-0001	192
BKY805P-FBP-05	120119-0023	35, 97	BTY4050-FBP-05	120114-0042	60, 122	C29300NOT	121205-0005	192
BKY8120-FBP-01	120119-0025	36, 98	BTY405N-FBP-05	120114-0037	60, 122	C92200NOT	121203-0001	190
BM5G30PP4M010	120098-0190	318	BTY405P-FBP-05	120114-0039	60, 122	CA3000-39	130070-0021	211
BM5G31PP4M010	120098-0194	318	BTY4120-FBP-05	120114-0048	61, 123	CA3006-39	130070-0022	211
BM5G32PP4M010	120098-0192	318	BTY412N-FBP-05	120114-0192	61, 123	CA4000-39	130070-0023	211
BM5G33PP4M010	120098-0196	318	BTY412P-FBP-05	120114-0045	61, 123	CA4006-39	130070-0024	211
BM5G60PP4M010	120098-0150	318	BTY601P-FBB	120114-0055	54, 116	CC3030A48M020	130064-0065	207
BM5G61PP4M010	120098-0151	318	BTY6030-FBA	120114-0057	58, 120	CC3130A48M020	130064-0401	207
BM5G62PP4M010	120098-0186	318	BTY603N-FBA	120055-0670	58, 120	CC4030A48M020	130064-0187	207
BM5G63PP4M010	120098-0188	318	BTY603P-FBA	120114-0056	58, 120	CC4130A48M020	130064-0356	207
BM5G70PP4M010	120098-0048	318	BTY8000-FBP-05	120055-0583	59, 121	CR3000A30M005	130066-0110	210
BM5G72PP4M010	120098-0051	318	BTY800N-FBP-05	120114-8020	59, 121	CR3006A30M005	130066-0255	210
BM5S30PP4M010	120098-0155	317	BTY800P-FBP-05	120114-8022	59, 121	CR3100A30M005	130066-0256	210
BM5S31PP4M010	120098-0184	317	BTY8010-FBB	120114-0079	54, 116	CR3106A30M005	130066-0257	210
BM5S32PP4M010	120098-0057	317	BTY8010-FBC	120055-0321	55, 118	CR3C00A30M005	130066-0134	210
BM5S33PP4M010	120098-5007	317	BTY801N-FBB	120114-0059	54, 116	CR3C06A30M005	130066-0143	210
BM5S60PP4M010	120098-0062	317	BTY801N-FBC	120114-0060	55, 118	CR3D00A30M005	130066-0258	210
BM5S61PP4M010	120098-0223	317	BTY801P-FBB	120114-0065	54, 116	CR3D06A30M005	130066-0259	210
BM5S62PP4M010	120098-0065	317	BTY801P-FBC	120114-0066	55, 118	CR4000A30M005	130066-0152	210
BM5S63PP4M010	120098-0070	317	BTY8030-FBA	120114-0086	58, 120	CR4006A30M005	130066-0170	210
BNY401P-FBC	120113-0023	76, 132	BTY8030-FBB	120114-0087	56, 117	CR4100A30M005	130066-0260	210
BNY401P-FBP-05	120113-0025	77, 133	BTY8030-FBC	120055-0328	57, 119	CR4106A30M005	130066-0186	210
BNY403P-FBP-05	120113-5100	78, 134	BTY803N-FBA	120055-0672	58	CR4C00A30M005	130066-0189	210
BNY601P-FBC	120113-0026	76, 132	BTY803P-FBA	120114-0082	58, 120	CR4C06A30M005	130066-0203	210

Engineering No. Index

<i>Engineering No.</i>	<i>Order No.</i>	<i>Page</i>	<i>Engineering No.</i>	<i>Order No.</i>	<i>Page</i>	<i>Engineering No.</i>	<i>Order No.</i>	<i>Page</i>
CR4D00A30M005	130066-0261	210	DND02A-M010	130027-0012	257	DNDF12A-M010	130039-0523	260
CR4D06A30M005	130066-0262	210	DND03A-M010	130027-0037	257	DNDF13A-M010	130039-0245	260
DN-MTR (E)	112008-0013	227	DND09A-M010	130024-0207	241	DNDF19A-M010	130025-0013	243
DN-MTR-BAG	112008-0003	227	DND100	130039-0382	265	DNDF20A-M010	130027-0171	256
DN-MTR-CAL	112008-0004	227	DND100L	120039-0001	265	DNDF21A-M010	130039-0248	259
DN-MTR-KIT (E)	112008-0014	227	DND101	130039-0125	265	DNDF22A-M010	130028-0132	258
DN-PT1	130039-0390	281	DND10A-M010	130024-0215	239	DNDF23A-M010	130028-0163	258
DN-PT2	130039-0391	281	DND11A-M010	130025-0287	243	DNDF29A-M010	130039-0257	259
DN-PT3	130039-0393	281	DND12A-M010	130039-0145	260	DNDF30A-M010	130027-0161	256
DN00A-M500	130039-0368	234	DND13A-M010	130039-0151	260	DNDF31A-M010	130039-0259	259
DN00A-T100	130039-0369	234	DND150	130039-0385	265	DNDF32A-M010	130028-0172	258
DN01A-M010	130024-0028	240	DND150L	120039-0003	265	DNDF33A-M010	130028-0183	258
DN09A-M010	130024-0059	240	DND151	130039-0386	265	DNDF39A-M010	130039-0263	259
DN100	130039-0370	249	DND19A-M010	130025-0313	243	DNDF40-M010	130039-0545	269
DN100L	130039-0371	249	DND20A-M010	130027-0048	256	DNDF41A-M010	130039-0546	270
DN10A-M010	130024-0073	238	DND21A-M010	130039-0157	259	DNDF42A-M010	130039-0548	270
DN11A-M010	130025-0054	242	DND22A-M010	130028-0028	258	DNDF43A-M010	130039-0549	270
DN150	130039-0376	249	DND23A-M010	130028-0070	258	DNDF49A-M010	130039-0547	270
DN150L	130039-0072	249	DND29A-M010	130039-0175	259	DNDF90A-M010	130024-0355	239
DN2100	130039-0336	255	DND3020	130039-0341	252	DNDF91A-M010	130025-0546	243
DN3020	130035-0057	252	DND30A-M010	130027-0075	256	DNDF92A-M010	130039-0266	260
DN3020PM-1	130035-0060	250	DND31A-M010	130039-0179	259	DNDF93A-M010	130039-0551	260
DN3020PM-3	130035-0061	250	DND32A-M010	130028-0085	258	DNDF99A-M010	130025-0513	243
DN3200	130035-0071	252	DND33A-M010	130028-0104	258	DNDG00A-T100	130039-0346	237
DN4000	130036-0005	254	DND39A-M010	130039-0188	259	DNE00A-M500	130039-0347	235
DN4100	130036-0006	255	DND40-M010	130039-0127	269	DNE00A-T100	130039-0348	235
DN5000-M010	130039-0284	245	DND41A-M010	130039-0132	270	DNE01A-M010	130024-0249	240
DN5100-M010	130039-0299	245	DND4200	130037-0004	268	DNE10A-M010	130024-0260	238
DN5210A-M010	130039-0096	244	DND42A-M010	130039-0190	270	DNE11A-M010	130025-0352	242
DN5290A-M010	130039-0098	244	DND4300-02	130037-0005	267	DNESJ	130035-0077	282
DN5301A-M010	130039-0101	244	DND43A-M010	130039-0204	270	DNEST	130035-0081	282
DN5309A-M010	130039-0103	244	DND4500-02	130037-0006	267	DNETAUXPT	130035-0085	152, 282
DN6000	130036-0008	254	DND49A-M010	130039-0122	270	DNF00A-M500	130039-0349	234
DN6100	130036-0009	255	DND5304-M010	130039-0087	271	DNF00A-T100	130039-0350	234
DN8000	130036-0010	254	DND8200	130037-0008	268	DNF01A-M010	130024-0265	240
DN90A-M010	130024-0133	238	DND8300-02	130037-0010	267	DNF09A-M010	130025-0538	240
DN91A-M010	130025-0173	242	DND8500-02	130037-0011	267	DNF10A-M010	130024-0337	238
DN99A-M010	130025-0197	242	DND90A-M010	130024-0232	239	DNF11A-M010	130025-0408	242
DNAPT	130035-0072	282	DND91A-M010	130025-0322	243	DNF90A-M010	130024-0341	238
DNAUX4000	130060-0065	157	DND92A-M010	130039-0209	260	DNF91A-M010	130025-0468	242
DNAUX8000	130060-0066	157	DND93A-M010	130039-0216	260	DNF99A-M010	130025-0482	242
DNB00A-M500	130039-0339	235	DND99A-M010	130025-0543	243	DNTA14114A1	130038-0016	277
DNB00A-T100	130039-0340	235	DNDC220A-M005	130039-0223	261	DNYG001	130039-0396	266
DNB01A-M010	130024-0146	240	DNDC230A-M010	130031-0014	261	DRL-241P-MSC	112036-0043	343
DNB09A-M010	130024-0163	240	DNDC302A-M005	130039-0230	261	DRL-241P-MST	112036-0044	343
DNB10A-M010	130024-0169	238	DNDC303A-M005	130031-0012	261	DRL-250M	112036-0036	343
DNB11A-M010	130025-0233	242	DNDC304-M005	130033-0003	271	DRL-250P	112036-0035	343
DNB5000-M010	130039-0312	245	DNDF00A-T100	130039-0344	236	DRL-280M	112036-0038	343
DNB5100-M010	130039-0318	245	DNDF01A-M010	130024-0005	241	DRL-280P	112036-0037	343
DNB90A-M010	130024-0178	238	DNDF02A-M010	130027-0103	257	DRL-281P-MSC	112036-0045	343
DNB91A-M010	130025-0259	242	DNDF03A-M010	130027-0115	257	DRL-281P-MST	112036-0046	343
DNB99A-M010	130025-0267	242	DNDF09A-M010	130024-0356	241	DRL-332M-MSC	112036-0047	343
DND00A-T100	130039-0381	236	DNDF10A-M010	130024-0353	239	DRL-332M-MST	112036-0048	343
DND01A-M010	130024-0191	241	DNDF11A-M010	130025-0502	243	DRL-332M-SSC	112036-0049	343

Engineering No. Index

<i>Engineering No.</i>	<i>Order No.</i>	<i>Page</i>	<i>Engineering No.</i>	<i>Order No.</i>	<i>Page</i>	<i>Engineering No.</i>	<i>Order No.</i>	<i>Page</i>
DRL-332M-SST	112036-0050	343	E11A06003M010	130048-0088	361	E66A06003M010	130048-0031	346
DRL-350M	112036-0039	343	E11A06004M010	130048-0095	361	ENDR2FB5	130053-0002	349
DRL-362M-MSC	112036-0051	343	E11A06005M010	120108-0188	361	ENP1105M010	130050-0071	347
DRL-362M-MST	112036-0052	343	E11A06010M010	130048-0114	361	ENP1115M010	130050-0076	348
DRL-362M-SSC	112036-0053	343	E11A06011M010	120108-0236	361	ENP1135M010	130050-0093	348
DRL-362M-SST	112036-0058	343	E11A06015M010	130048-0122	361	ENP1305M010	130050-0105	344
DRL-380M	112036-0040	343	E11A06203M010	130048-0137	361	ENP1335M010	130050-0107	345
DRL-3FOM	112036-0041	343	E11A06205M010	120108-0189	361	ENP2105M010	130050-0112	347
DRL-3HOM	112036-0042	343	E11A06210M010	130048-0145	361	ENP2115M010	130050-0122	348
DRL-3HOM-1MLC	112036-0054	343	E11A06211M020	120108-0201	361	ENP2135M010	130050-0140	348
DRL-3HOM-1SLC	112036-0055	343	E11A06215M010	130048-0153	361	ENP2335M010	130050-0150	345
DRL-3HOM-2MLC	112036-0056	343	E11A06303M010	130048-0161	361	ENP3105M010	130050-0162	347
DRL-3HOM-2SLC	112036-0057	343	E11A06304M010	120108-0167	361	ENP3115M010	130050-0170	348
DRL-750	112111-5001	342	E11A06305M010	120108-0174	361	ENP3135M010	130050-8036	348
DRL-780	112105-5002	342	E11A06310M010	130048-0170	361	ENP3335M010	130050-0457	345
DRL-781	112105-5004	342	E11A06311M020	120108-0200	361	ENPR1FF5	130053-0004	350
DRL-ALL-SWF-S	112027-0002	335, 382	E11A06315M010	130048-0179	361	ENQ3105M010	130050-0506	347
DRL-ALL-SWF-U	112027-0003	335, 382	E11B03003M002	130048-0193	362	ENQ3115M010	130050-0251	348
DRL-ALL-SWL-S	112027-0005	335, 382	E11B03015M002	130048-0195	362	ENQ3135M010	130050-0262	348
DRL-ALL-SWL-U	112027-0006	335, 382	E152N3N10011	121040-0140	193	ENQ3335M010	130050-0507	345
DRL-CNO-104	112023-0007	379	E152N3N10K11	121040-0146	193	ENQAM315	130057-0001	354
DRL-CNO-104-B25	112023-5001	379	E152N3N20011	121040-0159	193	ENS1105M010	130050-0277	347
DRL-CNO-PCIE	112086-5018	380	E152N3N50011	121040-0589	193	ENS1115M010	130050-0284	348
DRL-CNO-PCU	112021-0014	380	E153N3N10021	121040-0210	193	ENS1335M010	130050-0324	345
DRL-DPM-104	112013-0003	290	E153N3N10K21	121040-1257	193	ENS2105M010	130050-0328	347
DRL-DPM-CPI	112018-5004	296	E153N3N20021	121040-0219	193	ENS2115M010	130050-0336	348
DRL-DPM-PCIE	112011-5028	293	E153N3N50021	121040-0230	193	ENS2135M010	130050-0371	348
DRL-DPM-PCU	112011-0008	293	E162N3N10021	121040-0295	194	ENS2305M010	130050-0392	344
DRL-DPS-SRM	112026-0013	300	E162N3N10K21	121040-0299	194	ENS2335M010	130050-0394	345
DRL-EIP-PCIE	112000-5033	337	E162N3N20021	121040-0305	194	ENS3105M010	130050-0408	347
DRL-EIP-PCU	112000-5030	337	E162N3N50021	121040-0320	194	ENS3115M010	130050-0412	348
DRL-EMB-PCIE	112000-5034	337	E16A03003M010	130048-0197	363	ENS3135M010	130050-0429	348
DRL-EMB-PCU	112000-5029	337	E16A03011M010	120108-0264	363	ENS3305M010	130050-0436	344
DRL-EPN-PCIE	112000-5032	337	E1AS00-52	130047-0017	364	ENS3335M010	130050-0503	345
DRL-EPN-PCU	112000-5031	337	E1AS06-52	130047-0018	364	ENSAM315	130057-0003	354
DRL-EPN-SWF-S	112027-5007	334	E1WB03003M002	130048-0207	366	ENSP1F5	130055-0001	352
DRL-MPI-PCU	112034-0018	292	E1WB03010M002	130048-0208	366	ENSP1F5M010	130055-0005	352
DRL-MPI-USB	112035-0001	290	E1WB03015M002	130048-0209	366	ENSP6F5	130055-0014	352
DRL-MPI-USB-DLL	112035-0002	290	E332N2N10011	121040-0422	197	ENSR1FB5	130055-0016	351
DRL-PFB-USB	112026-0014	290	E332N2N10K11	121040-0428	197	ENSR1FB5M010	130055-0020	351
DRL-PFB-USB-DLL	112026-0015	290	E332N2N20011	121040-0436	197	ENV3105M010	130050-8023	347
DRL-SIE-SWF-S	112027-5014	335, 382	E332N2N50011	121040-0451	197	ENV3115M010	130050-8025	348
DRL-SIE-SWF-U	112027-5015	335, 382	E333N2N10021	121040-1260	197	ENV3135M010	130050-8029	348
DRL-UPG-SWF	112027-0010	335, 382	E333N2N10K21	121040-0703	197	ENV3335M010	130050-0512	345
E10A00603M010	130048-0038	360	E333N2N20021	121040-0470	197	ER1PADAPTER	130054-0009	371
E10A00605M010	120108-0186	360	E333N2N50021	121040-0887	197	ER1PADAPTER90	130054-0010	371
E10A00610M010	130048-0046	360	E432N2N10011	121040-0491	196	ERWAAJ3000C050	120109-0004	367
E10A00611M050	130048-0281	360	E432N2N10K11	121040-0493	196	ERWAAJ4002M002	130054-0012	369
E10A00615M010	130048-0054	360	E432N2N20011	121040-0496	196	ERWAAJ4002M020	130054-0013	369
E10A00703M010	130048-0062	360	E432N2N50011	121040-0500	196	ERWAAU3000C050	120109-5001	367
E10A00705M010	120108-0187	360	E433N2N10021	121040-1258	196	ERWAAU7000C050	120109-5002	367
E10A00710M010	130048-0070	360	E433N2N10K21	121040-1109	196	ERWD2J30	120109-5003	368
E10A00711M050	130048-0286	360	E433N2N20021	121040-1259	196	ERWD2U30	120109-5004	368
E10A00715M010	130048-0078	360	E433N2N50021	121040-0511	196	ERWD2U70	120109-5005	368

Engineering No. Index

<i>Engineering No.</i>	<i>Order No.</i>	<i>Page</i>	<i>Engineering No.</i>	<i>Order No.</i>	<i>Page</i>	<i>Engineering No.</i>	<i>Order No.</i>	<i>Page</i>
ERWPAU7003M006	120109-0005	370	KRP6G06-103	120234-0005	184	M03S06PP4M010	120098-0202	314
ERWPAU7011M010	120108-0252	370	KRP6G07-1012	120234-0009	184	M03S07PP4M010	120098-8025	314
EWWA06003M010	120108-0066	365	KRP6G07-1052	120234-0013	184	MA9D00-32	120100-0004	313
EWWA06010M010	120108-0090	365	KRP6G46-1031	120234-0017	184	MA9D00-42	120103-5001	313
EWWA06015M010	120108-0042	365	KRP6P46-100	120234-0021	184	MA9DP0-32	120100-0003	313
EWWA06203M010	120108-0074	365	KRP8G00-113	120234-0003	183	MICT555	130035-0090	266
EWWA06210M010	120108-0098	365	KRP8G06-113	120234-0007	184	MM3G60PP4M010	120098-0204	316
EWWA06215M010	120108-0050	365	KRP8G07-1112	120234-0011	184	MM3G61PP4M010	120098-0207	316
EWWA06303M010	120108-0082	365	KRP8G07-1152	120234-0015	184	MM3G70PP4M010	120098-0211	316
EWWA06304M010	120108-5020	365	KRP8G46-1131	120234-0019	184	MM3G72PP4M010	120098-8035	316
EWWA06310M010	120108-0106	365	KRP8P46-110	120234-0023	184	MM3S60PP4M010	120098-0198	315
EWWA06315M010	120108-0058	365	KRS6G20-403	120231-0002	176	MM3S62PP4M010	120098-0200	315
K02100P80M100	120094-5022	180	KRS6G26-4031	120231-0023	177	MM3S63PP4M020	120098-0120	315
K02101P80M100	120094-0125	31, 55, 93, 118, 180	KRS6G27-4012	120231-0044	177	MP3G62PP4M010	120098-0206	316
K02201P80M100	120094-8013	31, 55, 93	KRS6G46-4041	120231-0066	178	MP3G63PP4M010	120098-0209	316
K02301P80M100	120094-5023	31, 55, 93, 118	KRS6P46-400	120231-0094	179	MP3G72PP4M010	120098-0213	316
K03000P80M100	120094-5003	180	KRS7G20-403	120231-0005	176	MP3S62PP4M010	120098-0199	315
K03001P80M100	120094-0044	32, 57, 94, 119, 180	KRS7G26-4031	120231-0026	177	MP3S63PP4M020	120098-0122	315
K03201P80M100	120094-8027	32, 57, 94, 119	KRS7G27-4012	120231-0047	177	N03FA03124	120091-0001	75, 131
K03301P80M100	120094-8045	32, 57, 94	KRS7G46-4041	120231-0070	178	N03FA04124	120091-0003	75, 131
KA-FLANGE	120155-0016	185	KRS7P46-400	120231-0098	179	N03MA03124	120091-0004	75, 131
KAP6S00-105	120233-0001	181	KRS9G20-423	120231-0008	176	N03MA04124	120091-0006	75, 131
KAP6S01-105	120233-0009	181	KRS9G26-4131	120231-0029	177	N04FA03124	120091-0007	75, 131
KAP6S06-105	120233-0017	182	KRS9G27-4112	120231-0050	177	N04FA04124	120091-0009	75, 131
KAP8S00-115	120233-0005	181	KRS9G46-4141	120231-0074	178	N04MA03124	120091-0010	75, 131
KAP8S01-115	120233-0013	181	KRS9P46-410	120231-0102	179	N04MA04124	120091-0012	75, 131
KAP8S06-115	120233-0021	182	KRSCG20-023	120231-0011	176	P03S07PP4M010	120098-0203	314
KAS6S00-405	120230-0005	174	KRSCG26-0131	120231-0032	177	PA9D01-42	120103-0001	313
KAS6S06-405	120230-0110	175	KRSCG27-0112	120231-0053	177	PA9D0B-42	120103-0003	313
KAS7S00-405	120230-0014	174	KRSCG46-0141	120231-0078	178	PA9S01-42	120103-0005	313
KAS7S01-405	120230-0072	174	KRSCP46-010	120231-0106	179	PBAPT	120101-0001	152, 322
KAS7S06-405	120230-0119	175	KRSHG20-023	120231-0106	176	PDT501	120101-0002	312
KAS9S00-425	120230-0023	174	KRSHG26-0131	120231-0035	177	PICS-PRO-AB	112029-0008	384
KAS9S01-425	120230-0078	174	KRSHG27-0112	120231-0056	177	PICS-PRO-OPC	112029-0011	384
KAS9S06-415	120230-0128	175	KRSHG46-0141	120231-0082	178	PICS-PRO-PBMS	112029-0012	384
KASCS00-025	120230-0032	31, 55, 93, 118, 174	KRSHP46-010	120231-0110	179	RJBG16821	130058-0057	353, 353
KASCS01-025	120230-0084	174	KRSJG20-023	120231-0017	176	SDK-CIP-EDS-SAF	112115-0005	231, 341
KASCS06-015	120230-0137	175	KRSJG26-0131	120231-0038	177	SDK-DEP-SAP-SAF	112115-0003	231, 341
KASHS00-025	120230-0041	174	KRSJG27-0112	120231-0059	177	SDK-DEP-SAP-SAF-O	112115-0004	231, 341
KASHS01-025	120230-0090	174	KRSJG46-0141	120231-0086	178	SDK-DNS-SAF	112115-0001	231, 341
KASHS06-015	120230-0146	175	KRSJP46-010	120231-0114	179	SDK-DNS-SAF-L	112116-0001	231, 341
KASJS00-025	120230-0050	174	KRSLG20-223	120231-0020	176	SDK-DNS-SAF-O	112115-0002	231, 341
KASJS01-025	120230-0096	174	KRSLG26-1131	120231-0041	177	SDK-EIP-ADP	112106-0000	333
KASJS06-015	120230-0155	175	KRSLG27-1112	120231-0062	177	SDK-EIP-ADP-SAF	112117-0001	231, 341
KASLS01-225	120230-0102	174	KRSLG46-1141	120231-0090	178	SDK-EIP-ADP-SAF-L	112116-0002	231, 341
KASLS06-115	120230-0164	175	KRSLP46-110	120231-0118	179	SDK-EIP-ADP-SAF-O	112117-0002	231, 341
KP-LOC-01	120155-0018	185	KS-LOC-01	120155-0013	185	SDK-EIP-ADP-UPD	112106-5000	333
KP-LOC-02	120155-0019	185	KS-LOC-02	120155-0014	185	SDK-EIP-CON-CNF-U	112106-5011	333
KP-TOOL-01	120155-0017	185	KS-TOOL-01	120155-0012	185	SDK-EIP-EDS	860000-0141	333
KRP6G00-103	120234-0001	183	KS-TOOL-02	120155-0015	185	SDK-EIP-EML	112106-5008	334
			L04101M78M100	130023-0055	76, 132	SDK-EIP-SCA	112106-5003	333
			L04201M78M100	130023-0059	76, 132	SDK-EIP-SCA-UPD	112106-5004	333
			L04301M78M100	130023-0063	76, 132	SDK-EIP-TRN	860000-0143	333
			L04A01M78M100	130023-0068	76, 132	SDK-PFN-CON	112106-5005	332

Engineering No. Index

<i>Engineering No.</i>	<i>Order No.</i>	<i>Page</i>	<i>Engineering No.</i>	<i>Order No.</i>	<i>Page</i>	<i>Engineering No.</i>	<i>Order No.</i>	<i>Page</i>
SDK-PFN-CON-CNF-U	112106-5012	332	TBDCO-8YXX-804	112098-5008	383	TCDEI-8YXX-DYU	112095-5020	340
SDK-PFN-CON-UPD	112106-5006	332	TBDDN-444N-88U	112092-5004	233	TCDEM-888N-D1U	112095-0001	339
SDK-PFN-DEV	112106-5001	332	TBDDN-444P-88U	112092-0006	233	TCDEM-888N-DYU	112095-5024	339
SDK-PFN-DEV-UPD	112106-5002	332	TBDDN-480N-80U	112092-0018	233	TCDEM-888P-D1U	112095-0002	339
SDK-PFN-EDS	860000-0142	332	TBDDN-480P-80U	112092-0007	233	TCDEM-888P-DYU	112095-5028	339
SDK-PFN-MRP	112106-5007	332	TBDDN-880N-804	112092-0022	233	TCDEM-8B4N-D1U	112095-0003	339
SDK-PFN-TRN	860000-0144	332	TBDDN-880P-804	112092-0008	233	TCDEM-8B4N-DYU	112095-5023	339
SST-ASI-SLC	112019-0004	378	TBDPB-408P-B8U	112038-0003	302	TCDEM-8B4P-D1U	112095-0004	339
SST-CCS-PCU	112079-7002	379	TBDPB-444N-B8U	112038-0005	302	TCDEM-8B4P-DYU	112095-5027	339
SST-CCS-PCU-B50	112079-7001	379	TBDPB-444P-B8U	112038-0006	302	TCDEM-8C2N-D1U	112095-0005	339
SST-DN3-CNF-U	112030-0007	230	TBDPB-462N-B8U	112038-0007	302	TCDEM-8C2N-DYU	112095-5022	339
SST-DN3-OPC	112027-0014	230	TBDPB-462P-B8U	112038-0008	302	TCDEM-8C2P-D1U	112095-0006	339
SST-DN4-104-1	112005-0040	228	TBDPB-480N-B8U	112038-0009	302	TCDEM-8C2P-DYU	112095-5026	339
SST-DN4-104-2	112005-0048	228	TBDPB-480P-B8U	112038-0011	302	TCDEM-8DON-D1U	112095-0007	339
SST-DN4-PCU	112113-0007	228	TBDPB-808P-B84	112038-0014	302	TCDEM-8DON-DYU	112095-5021	339
SST-DN4-PCU-2	112113-0005	228	TBDPB-844N-B84	112038-0015	302	TCDEM-8DOP-D1U	112095-0008	339
SST-DN4-PCU-H	112113-0001	228	TBDPB-844P-B84	112038-0016	302	TCDEM-8DOP-DYU	112095-5025	339
SST-DN4-USB	112076-0001	229	TBDPB-862N-B84	112038-0017	302	TCDEM-8YXX-D1U	112095-0009	339
SST-DN4-USB-SM	112076-0002	229	TBDPB-862P-B84	112038-0018	302	TCDEM-8YXX-DYU	112095-5038	339
SST-DNMS4-PCU	112113-0009	228	TBDPB-880N-B84	112038-0019	302	TCDEP-8C2P-D1U	112095-5034	340
SST-DNMS4-PCU-H	112113-0010	228	TBDPB-880P-B84	112038-0021	302	TCDEP-8DON-D1U	112095-5029	340
SST-EDN-1	112034-0021	226	TC30130-200	130068-0034	208	TCDEP-8DOP-D1U	112095-5033	340
SST-EDN-1-C2	112034-0026	226	TC30200A45M010	130068-0039	208	TCDEP-8YXX-D1U	112095-5037	340
SST-ENM-DN1	112008-0008	227	TC30200A46M010	130068-0042	208	TCDPB-888N-B1U	112038-0024	301
SST-ENM-PTU	112008-0016	227	TC30C30-200	130068-0045	208	TCDPB-888P-B1U	112038-0025	301
SST-ENM-SKT	112008-0012	227	TC31130-200	130068-0051	208	TCDPB-8B4N-B1U	112038-0026	301
SST-ESR2-CLX-RLL	112073-0001	338	TC31C31-200	130068-0055	208	TCDPB-8B4P-B1U	112038-0027	301
SST-NAS-DN1	112008-0011	227	TC40140-200	130068-0069	208	TCDPB-8C2N-B1U	112038-0028	301
SST-PB3-104	112013-0013	291	TC40200A45M010	130068-0072	208	TCDPB-8C2P-B1U	112038-0029	301
SST-PB3-104-B25	112013-0015	291	TC40200A46M010	130068-0075	208	TCDPB-8DON-B1U	112038-0030	301
SST-PB3-CLX-RLL	112016-0018	299	TC40C40-200	130068-0079	208	TCDPB-8DOP-B1U	112038-0031	301
SST-PB3-CLX-RLL-CC	112016-0023	299	TC41140-200	130068-0082	208	W03000A09M020	120079-0138	20
SST-PB3-CNF-P	112030-0008	291, 294, 297	TC41C41-200	130068-0086	208	W03000E03M020	120079-5102	82
SST-PB3-CNF-U	112030-0009	291, 294, 297	TCDDN-888N-11U	112092-0020	232	W03000H09M020	120079-8042	82
SST-PB3-OPC	112028-0030	291, 294	TCDDN-888P-11U	112092-0009	232	W03000K05M020	120079-0130	20, 82
SST-PB3-PCIE-1	112011-0031	294	TCDDN-8DON-10U	112092-0019	232	W03000P03M020	120079-5103	82
SST-PB3-PCIE-2	112011-0032	294	TCDDN-8DOP-10U	112092-0010	232	W03001A09M020	120079-0216	20
SST-PB3-PCU	112011-0021	294	TCDEI-888N-D1U	112095-5006	340	W03001E03M020	120079-5048	82
SST-PB3-PCU-2	112011-0022	294	TCDEI-888N-DYU	112095-5015	340	W03001H09M020	120079-8047	82
SST-PB3-PCU-2-B	112011-0027	294	TCDEI-888P-D1U	112095-5010	340	W03001K05M020	120079-0211	20, 82
SST-PB3-PCU-B25	112011-0024	294	TCDEI-888P-DYU	112095-5019	340	W03001P03M020	120079-5104	82
SST-PB3-SLC	112016-0022	298	TCDEI-8B4N-D1U	112095-5005	340	W03006A09M020	120079-0175	21
SST-PB3-VME-1	112014-0004	297	TCDEI-8B4N-DYU	112095-5014	340	W03006E03M020	120079-5105	83
SST-PB3-VME-2	112014-0006	297	TCDEI-8B4P-D1U	112095-5009	340	W03006H09M020	120079-8049	83
SST-PBMS-PCI	112011-0025	295	TCDEI-8B4P-DYU	112095-5018	340	W03006K05M020	120079-0155	21, 83
SST-PICS-PRO-U	112029-0027	384	TCDEI-8C2N-D1U	112095-5004	340	W03006P03M020	120079-5106	83
SST-SR4-CLX-RLL	112078-0001	378	TCDEI-8C2N-DYU	112095-5013	340	W03007A09M020	120079-0220	21
TBDCO-808P-804	112098-5001	383	TCDEI-8C2P-D1U	112095-5008	340	W03007E03M020	120079-5107	83
TBDCO-844N-804	112098-5002	383	TCDEI-8C2P-DYU	112095-5017	340	W03007H09M020	120079-8041	83
TBDCO-844P-804	112098-5003	383	TCDEI-8DON-D1U	112095-5003	340	W03007K05M020	120079-0226	21, 83
TBDCO-862N-804	112098-5004	383	TCDEI-8DON-DYU	112095-5012	340	W03007P03M020	120020-0002	83
TBDCO-862P-804	112098-5005	383	TCDEI-8DOP-D1U	112095-5007	340	W04000A09M020	120079-0164	20
TBDCO-880N-804	112098-5006	383	TCDEI-8DOP-DYU	112095-5016	340	W04000E03M020	120079-0266	82
TBDCO-880P-804	112098-5007	383	TCDEI-8YXX-D1U	112095-5011	340	W04000H09M020	120079-8054	82

Engineering No. Index

<i>Engineering No.</i>	<i>Order No.</i>	<i>Page</i>	<i>Engineering No.</i>	<i>Order No.</i>	<i>Page</i>	<i>Engineering No.</i>	<i>Order No.</i>	<i>Page</i>
W04000K05M020	120079-0149	20, 82	WA4007-31	120085-0007	27, 89	WW3032H09M010	120080-8029	85
W04000P03M020	120079-8012	82	WA5000-31	120085-0012	27, 89	WW3032K05M010	120080-0281	23, 85
W04001A09M020	120079-0232	20	WA5000-32	120085-0014	27, 89, 286, 329	WW3032P03M010	120080-5063	85
W04001E03M020	120079-0269	82	WA5001-31	120085-0016	27, 89	WW3033A09M010	120080-0351	23
W04001H09M020	120079-8051	82	WA5006-31	120085-0004	27, 89	WW3033E03M010	120080-5064	85
W04001K05M020	120079-0221	20, 82	WA5006-32	120085-0006	27, 89, 286, 329	WW3033H09M010	120080-8025	85
W04001P03M020	120079-8013	82	WA5007-31	120085-0008	27, 89	WW3033K05M010	120080-0364	23, 85
W04006A09M020	120079-0107	21	WR4000A18C300	120084-0007	25	WW3033P03M010	120080-5065	85
W04006E03M020	120079-0263	83	WR4006A18C300	120084-0008	26	WW4030A09M010	120080-0403	22
W04006H09M020	120079-8053	83	WR4J20E03C3003	120084-5154	87	WW4030E03M010	120080-0469	84
W04006K05M020	120079-0156	21, 83	WR4J26E03C3003	120084-5103	88	WW4030H09M010	120080-8031	84
W04006P03M020	120079-8006	83	WR4U20E03C3003	120084-5107	87	WW4030K05M010	120080-0417	22, 84
W04007A09M020	120079-0187	21	WR4U26E03C3003	120084-5108	88	WW4030P03M010	120080-5045	84
W04007E03M020	120079-5108	83	WR4W400003	120084-5175	25, 87	WW4031A09M010	120080-0337	22
W04007H09M020	120079-8052	83	WR4W40E03C3003	120084-5189	87	WW4031E03M010	120080-5066	84
W04007K05M020	120079-0192	21, 83	WR4W460003	120084-5180	26, 88	WW4031H09M010	120080-8027	84
W04007P03M020	120079-5109	83	WR4W46E003C3003	120084-5183	88	WW4031K05M010	120080-0300	22, 84
W05000A09M020	120079-0109	20, 283, 323	WR5000A18A120	120084-0016	285, 327	WW4031P03M010	120080-5067	84
W05000E03M020	120079-0277	82, 325	WR5000A18C300	120084-0016	25	WW4032A09M010	120080-0347	23
W05000H09M020	120079-8045	82	WR5006A18C300	120084-0017	26	WW4032E03M010	120080-5068	85
W05000P03M020	120079-5110	82	WR5J20E03C3003	120084-5159	87, 328	WW4032H09M010	120080-8036	85
W05001A09M020	120079-0223	20, 283, 323	WR5J26E03C3003	120084-5109	88	WW4032K05M010	120080-0306	23, 85
W05001E03M020	120079-0281	82, 325	WR5U20E03C3003	120084-5113	87	WW4032P03M010	120080-5069	85
W05001H09M020	120079-8048	82	WR5U26E03C3003	120025-0007	88	WW4033A09M010	120080-0391	23
W05001P03M020	120079-5088	82	WR5W400003	120084-5179	25, 87	WW4033E03M010	120080-5070	85
W05006A09M020	120079-0092	21	WR5W40E03C3003	120084-5190	87	WW4033H09M010	120080-8037	85
W05006E03M020	120079-0273	83	WR5W460003	120084-5181	26, 88	WW4033K05M010	120080-0396	23, 85
W05006H09M020	120079-8046	83	WR5W46E03C3003	120084-5185	88	WW4033P03M010	120080-5071	85
W05006P03M020	120079-5055	83	WR8U20E02C3003	120084-5095	25, 87	WW4A30A09M003	120080-0001	28
W05007A09M020	120079-0239	21	WR8U26E02C3003	120084-5096	26, 88	WW4A30E03M003	120080-5072	90
W05007E03M020	120079-5111	83	WR8W400003	120084-0048	25, 87	WW4A30H09M003	120080-8048	90
W05007H09M020	120079-8050	83	WR8W40E02C300	120084-5191	25, 87	WW4A30K05M003	120080-0081	28, 90
W05007P03M020	120079-5112	83	WR8W460003	120084-0047	26, 88	WW4A30P03M003	120080-5073	90
W08000H08M020	120079-5023	82	WR8W46E02C300	120084-5187	26, 88	WW4A31A09M003	120080-0005	28
W08000P02M020	120079-5113	20, 82	WRCU20E01C3003	120084-5013	25, 87	WW4A31E03M003	120080-5074	90
W08001H08M020	120079-8043	82	WRCU26E01C3003	120084-5015	26, 88	WW4A31H09M003	120080-8049	90
W08001P02M020	120079-5114	20, 82	WRCW400003	120084-5176	25, 87	WW4A31K05M003	120080-0089	28, 90
W08006H08M020	120079-5026	83	WRCW40E01C300	120084-5192	25, 87	WW4A31P03M003	120080-5075	90
W08006P02M020	120079-5115	21, 83	WRCW460003	120084-5182	26, 88	WW5030A09M010	120080-0325	22, 284, 324
W08007H08M020	120079-8044	83	WRCW46E01C300	120084-5188	26, 88	WW5030E03M010	120080-5076	84, 326
W08007P02M020	120079-5116	21, 83	WW3030A09M010	120080-0276	22	WW5030H09M010	120080-8039	84
W08500P19M020	120079-5029	24, 86	WW3030E03M010	120080-5058	84	WW5030P03M010	120080-5050	84
W08506P19M020	120079-5033	24, 86	WW3030H09M010	120080-8026	84	WW5031A09M010	120080-0382	22
W0C000H45M020	120079-5001	20, 82	WW3030K05M010	120080-0414	22, 84	WW5031E03M010	120080-5077	84
W0C001H45M020	120079-5117	20, 82	WW3030P03M010	120080-5059	84	WW5031H09M010	120080-8028	84
W0C006H45M020	120079-5006	21, 83	WW3031A09M010	120080-0429	22	WW5031P03M010	120080-5078	84
W0C007H45M020	120079-5118	21, 83	WW3031E03M010	120080-5060	84	WW5032A09M010	120080-0378	23
W0C500P45M020	120083-5010	24, 86	WW3031H09M010	120080-8030	84	WW5032E03M010	120080-5079	85
W0C506P45M020	120083-5015	24, 86	WW3031K05M010	120080-0286	22, 84	WW5032H09M010	120080-8038	85
WA4000-31	120085-0011	27, 89	WW3031P03M010	120080-5061	84	WW5032P03M010	120080-5080	85
WA4000-32	120085-0013	27, 89	WW3032A09M010	120080-0419	23	WW5033A09M010	120080-0431	23, 284, 324
WA4001-31	120085-0015	27, 89	WW3032E03M010	120080-5062	85	WW5033E03M010	120080-5081	85, 326
WA4006-31	120085-0003	27, 89				WW5033H09M010	120080-8040	85
WA4006-32	120085-0005	27, 89				WW5033P03M010	120080-5082	85

Engineering No. Index

<i>Engineering No.</i>	<i>Order No.</i>	<i>Page</i>
WW8030H08M010	120080-8033	84
WW8030P02M010	120080-5083	22, 84
WW8031H08M010	120080-8034	84
WW8031P02M010	120080-5084	22, 84
WW8032H08M010	120080-8035	85
WW8032P02M010	120080-5085	23, 85
WW8033H08M010	120080-8032	85
WW8033P02M010	120080-5086	23, 85
WW8530P19M010	120083-5183	24, 86
WWC030H45M010	120080-5088	22, 84
WWC031H45M010	120080-5089	22, 84
WWC032H45M010	120080-5090	23, 85
WWC033H45M010	120080-5023	23, 85
WWCS30P45M010	120083-5044	24, 86
84586-0017		393
84586-0018		392
84586-0019		392
84695-9095		386
84700-0001		358
84700-0002		359
84700-0003		359
84700-0003		407
84702-0005		358
84702-0006		358
84702-0007		358
84702-0008		358
84702-0009		358
84702-1003		356
84702-1006		356
84702-1010		356
84702-1020		356
84702-2003		357
84702-2007		357
84702-2010		357
84702-2012		357
84702-2015		357
84702-2020		357
84702-2021		357
84702-3020		355
84727-1001		404
84727-1002		404
84727-1003		404
84727-1004		404
84727-1005		404
84728-1001		405
84728-1002		405
84728-1003		405
84728-1004		405
84728-1005		405
84729-0001		406
84729-0003		405
84729-0004		405
84729-0005		405
84729-0006		405

<i>Engineering No.</i>	<i>Order No.</i>	<i>Page</i>
84729-0007		405
84729-0008		405
84729-0009		406
84730-0010		406
84732-0001		404
84732-0002		404
84732-0003		404
84732-0004		404
84732-0005		404
84854-6034		389
84854-6035		389
84854-6036		389
84854-6037		389
84854-6038		389
84854-6039		389
84854-6041		389
84854-6042		389
84854-6043		389
84854-6044		389
84854-6055		389
84854-7021		387
84854-7022		387
84854-7023		387
84854-7024		387
84854-7025		387
84854-7026		387
84854-7027		387
84854-7028		387
84854-7029		387
84854-7030		387
84854-7031		387
84854-8021		388
84854-8022		388
84854-8023		388
84854-8024		388
84854-8025		388
84854-8026		388
84854-8027		388
84854-8028		388
84854-8029		388
84854-8030		388
84854-8031		388
84854-9019		402
84854-9300		402
84854-9316		386
84854-9319		392
84856-1200		396
84856-1201		396
84856-1202		396
84856-1203		396
84856-1204		396
84856-1205		396
84856-1206		396
84856-1207		396

<i>Engineering No.</i>	<i>Order No.</i>	<i>Page</i>
84856-1208		396
84856-1209		396
84856-1210		396
84856-9101		397
84856-9102		397
84856-9103		402
84856-9104		399
84856-9105		399
84856-9106		402
84856-9107		402
84856-9108		398
84856-9109		398
84856-9110		398
84856-9111		398
84856-9112		400
84856-9113		401
84856-9114		401
84856-9115		401
84859-9001		395
84859-9002		395
84859-9003		395
84859-9004		395
84863-9001		394
84863-9002		394
84863-9003		394
84864-9001		390
84864-9002		390
84864-9003		390
84864-9004		390
84864-9005		390
84864-9006		390

All trademarks used herein are the property of their respective owners. Reference to any non-Molex trademarks is not intended to claim any endorsement or association between Molex and the respective trademark owners, and should not be construed.

www.molex.com/automation.html



molex[®]
one company › a world of innovation