

Brad Core Program > Industrial Automation

Americas Region

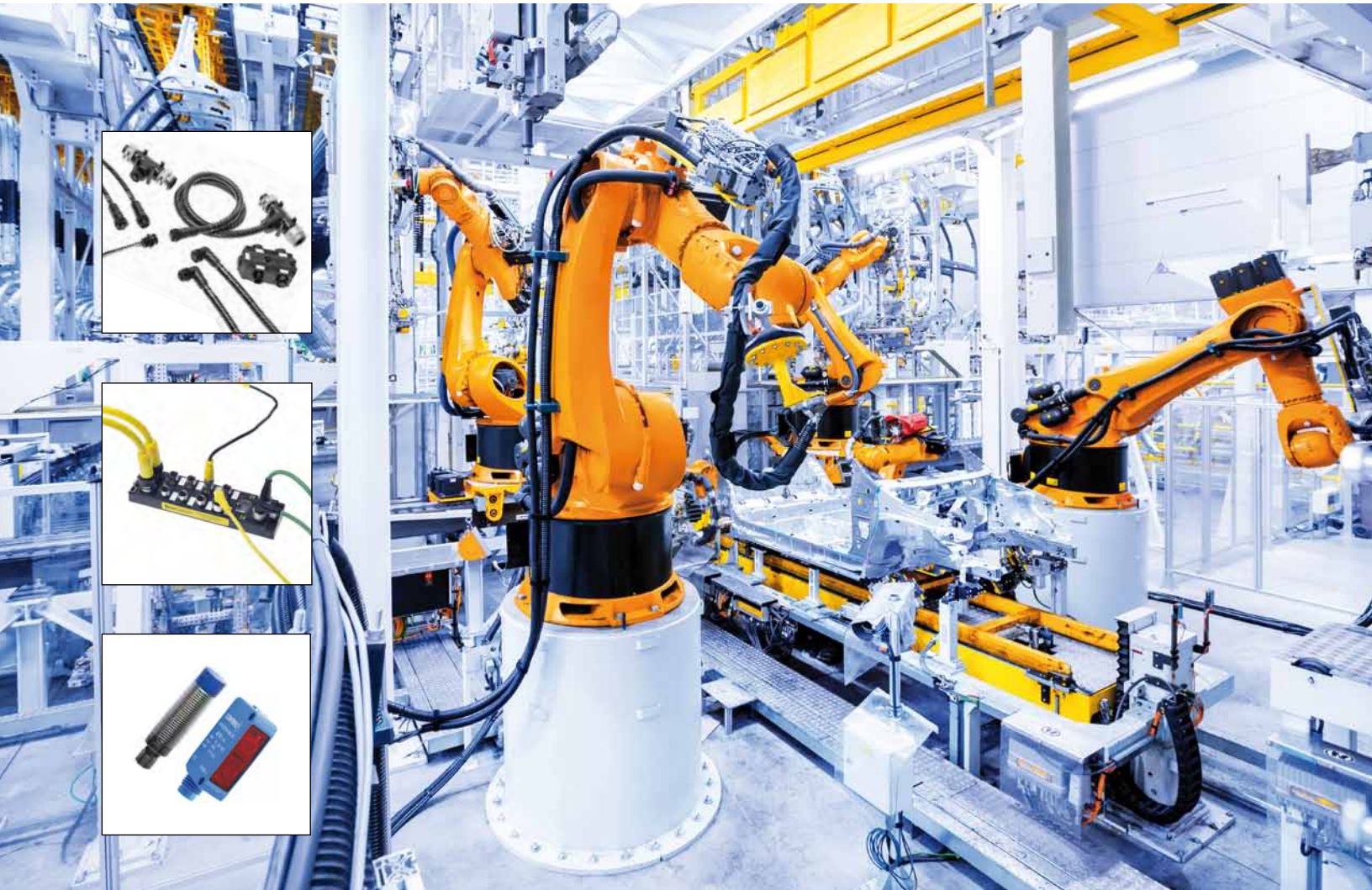

molex

Find the Latest Innovations and Information **at molex.com**

For the most in-depth and up-to-date information on all our products, visit molex.com. It's designed to help you get more done in less time with advanced search capabilities, 3D models, product specifications, easy sample ordering and more.



Mobile App for Anytime, Anywhere Access to Molex Connector Solutions.

The Molex App gives apple and android tablet and smartphone users ready-access to information on over 90 different Molex product families. Users can visually compare product ranges, access product information and view datasheets offline. App users with an internet connection can directly link to Molex.com for more detailed part number information and product videos. Download the free app now at the App Store and GooglePlay.

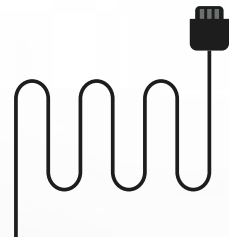
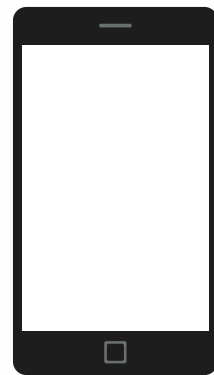

TABLE OF CONTENTS

Molex Solutions Advantages and Benefits	6
Network Infrastructure Components	
Brad EtherNet/IP HarshIO Modules	16
Brad PROFINET HarshIO Modules	21
Brad DeviceNet HarshIO Modules	25
Brad IO-Link HarshIO Modules	26
Brad Harsh Duty Ethernet Switches	27
Brad EtherNet/IP Infrastructure Connectivity	28
Brad CAT6A Ethernet M12 X-Code Infrastructure Connectivity	32
Brad PROFINET Infrastructure Connectivity	34
Brad DeviceNet Infrastructure Connectivity	36
Sensor Solutions	
Inductive Sensors	42
Photoelectric Sensors	44
Sensor and Actuator Connectivity	
Brad MPIS Sensor/Actuator Distribution Boxes	50
Brad Micro-Change M12 Sensor/Actuator Connectivity	52
Brad Nano-Change M8 Sensor/Actuator Connectivity	61
Brad mPm DIN Valve Connectors	70
Power Distribution Connectivity	
BradPower Modular Power Solutions	74
Brad Mini-Change 7/8" Auxiliary Power Infrastructure Components	82
Brad Micro-Change M12 A-Code Auxiliary Power Infrastructure Components	90

The products you need... when and where you need them.

Brad products pioneered the market for rugged connectors in industrial applications since the introduction of the Mini-Change in 1968.

Today Molex supports one of the largest portfolios of connectivity and wiring solutions and defined the standards in the industrial market, covering multiple segments and applications:

- **Automotive Production Lines:**

Brad products are designed to withstand even the harshest environments with resistance to weld slag, abrasion, cuts and continuous flexing. Providing the foundation for your manufacturing plant, Brad Connectivity Solutions are used in metal stamping, body-weld, paint, final assembly and powertrain.

With functional safety as one of the most vital requirements on every factory floor, Molex has developed innovative solutions for Safety I/O modules which simplify the safety architecture of complex robotic work cells.

- **Material Handling**

The combination of Brad products with Molex Heavy Duty Connectors and Flamar cables enables the creation of compact connection systems that accommodate the multiple connector interfaces as needed for Material Handling applications.

The Brad MDR Harsh IO Modules provide a reliable Ethernet based solution for the control and power of industrial motor drive rollers (MDR).

- **Food and Beverage**

Brad Connectivity products are designed to meet the increasing need for IP67 and IP69K solutions in the food and beverage industry. The most unique and beneficial is the Brad M12 Ultra-Lock. Its patented technology provides a safe, reliable connection of sensors, actuators and other control devices.



The Brad Core Program

The Brad Core Program includes the most commonly used items in the industrial automation market, ranging from connectivity products and presence sensing devices to active and passive I/O modules.

These products are in-stock, or available with short lead times, aligned with market requirements.

For further information or assistance, please contact Brad Connectivity tech support at wctechsup@molex.com

Complete Solutions from Molex

molex

Molex is focused on offering value added solutions to the targeted markets through our long years of expertise and technology in communication protocols and connectivity solutions supported by multiple plants for in house production worldwide.

Competitive Advantages:

- Molex is a recognized industrial Communication Competence Center
Active in Automation and industrial committees boards like PNO, ODVA, CLPA, IEC, etc.
- Molex designs and markets its own industrial communication technology
PROFINET, EtherNet/IP and safety stacks widely in use by many of the major automation manufacturers
- Support a large array of fieldbus communication protocols; both Safe and non-Safe
 - Non-Safe: PROFIBUS, PROFINET, DeviceNet, EtherNet/IP, CC-Link, CC-Link IE, CanOpen, Modbus, EtherCAT, IO-Link.
 - Safe: CIP Safety, PROFSafe, CC-Link IE Safety
- Product design and manufacturing integration capabilities
 - Product development and customization
 - Product testing
 - Total Quality Process
- Fully integrated capabilities
Stamping, plating, moulding, assembly, electronic population and assembly, potting and overmolding



Brad HarshIO Modules

molex



Ethernet reliable solutions in harsh environments

Worldwide Unique Feature: Quicker Setups and More Uptime through Secure Connections Using the Brad Ultra-Lock Patented Connection System

- One simple push delivers a secure, consistent seal each and every time
- Eliminates connector-related intermittent signals that lead to costly production downtime
- Quick change-overs can now be a reality

React to Problems Sooner Using Easy-to-Read Diagnostics

- Visible LEDs provide maintenance personnel with ability to easily determine I/O, module and network status
- Built-in web server for remote monitoring, configuration and diagnostics

Reduce Infrastructure Costs with Built-in 2-Port Ethernet Switch

- 10/100 Mbps auto-sensing
- Supports straight or crossover Ethernet cable

Reduce Inventory Costs Using Configurable I/O

- User configurable I/O – Digital points can be set as either an Input or Output (product also available in fixed I/O versions)

Save Time Configuring or Replacing I/O Modules

- Thanks to Ethernet protocols, configuration setup can be downloaded into the product directly from the PLC
- With the 3 rotary switches, quickly adjust the last octets of the IP address

Save Energy by Minimizing Power Supply

- On PROFINET, HarshIO supports PROFlenergy service, allowing the IO-Controller to minimize power supply to the connected HarshIO Module(s)

Built-in Web Server

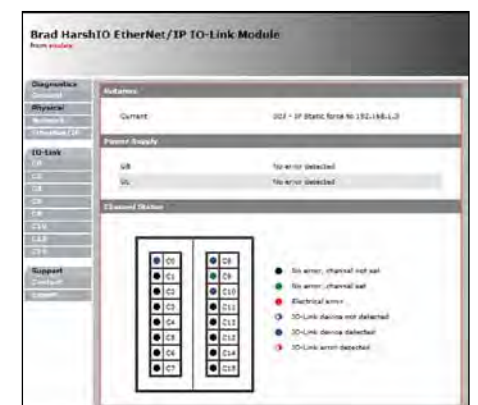
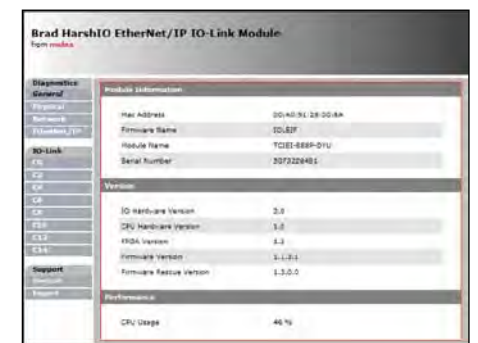

The module web server has no login and password. It is used to monitor the product information:

- Product version and configuration settings
- Protocol information
- Ethernet statistics
- Upload of description file (GSD/EDS)
- Technical support quick access

Brad HarshIO IO-Link Solutions

molex

Brad HarshIO modules supports the IO-Link Master communication standard to extend the digital link down at the sensor and actuator level. The capabilities and modularity of the IP67 solution are strongly enhanced in combination with the Brad IO-Link digital IO Hubs.

IO-Link, the Sensor/Actuator communication standard

- Increase up to 32 bytes the data amount with field devices
- Flexible production through online sensor parametrization
- Reduced maintenance and downtime through improved diagnostic capabilities

Infrastructure simplification and savings

The IO-Link technology allows significant infrastructure cost reductions compared to traditional shielded wiring required for analog signals or for networks and additional power supply cordsets as IO-Link requires only standard unshielded 3-pole cordsets and includes also the power supply for equipment.

Extreme modularity in IP67 protection

Each of the 8 IO-Link Master ports of the HarshIO module can be configured to manage standard digital I/O signals, high diversity of IO-Link devices or combined with Brad Analog Adapters any kind of Input or Output analog signals.

Molex IO-Link infrastructure devices are listed in the Ethernet Section following the description of the IO-Link HarshIO module.



Digital I/O concentrator

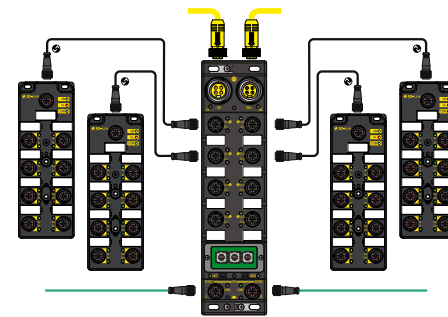

IO-Link allows to connect up to 8 IO-Link digital IO Hubs to extend the total count of digital I/O manageable by a single HarshIO IO-Link module up to 136 points, reducing the overall cost of I/O points.

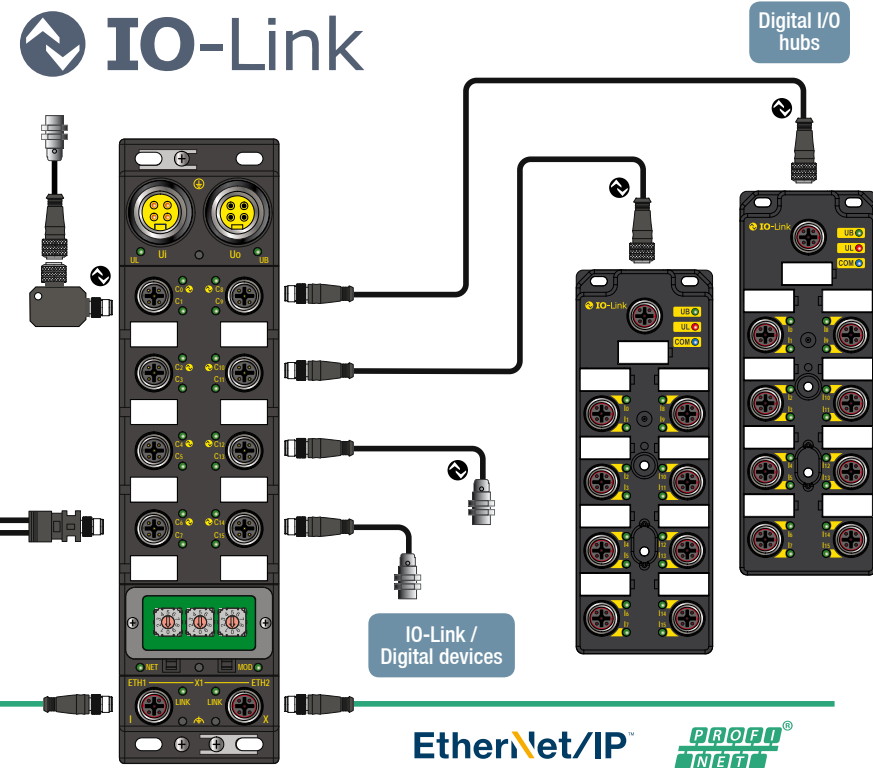

Brad Ethernet MDR Conveyor Classic Harsh IO Modules

molex

Brad MDR Conveyor Classic HarshIO Modules provide a reliable solution for designing industrial Motor driver roller (MDR) applications in harsh duty environments. Each module can connect 4+ drives and enables, through EtherNet/IP* and PROFINET⁽¹⁾ networks, the control from a PLC of the start/stop, direction and speed.



HarshIO Modules Benefits

- Simplifies systems by controlling up to 4 motor drive rollers (on one module) over Ethernet fieldbus
- Auto-detection of Interroll EC310 and ITOH DENKI PM500XE/XP MDR's
- Reduces the total number of power and network cables
- Active MDR protection and integrated predictive maintenance
- Eliminates the requirement to use a proprietary system from an MDR manufacturer[‡]
- 4 dedicated MDR Outputs and 8 User Configurable Digital PNP Inputs/Outputs
- Brad Ultra-Lock M12 technology delivers reliable and fast connection
- Description files (GSD/EDS) can be uploaded from the module for an easy integration in EtherNet/IP* (Rockwell Automation Studio 5000 Logix Designer™) and PROFINET (Siemens TIA Portal) PLC engineering tools
- I/O diagnostics and LEDs: quickly identifies problems and helps reducing machine downtime
- Operating temperature of -30 to +50°C



Typical Conveying Application

Ideally suited for many material handling applications such as postal distribution centers, airport baggage handling and conveying systems for production plants.

Combining Brad connectivity (power, I/O and network cordsets) and IP67 IO modules (digital, IO-Link and safety), Molex is able to deliver ready-to-use solutions to design conveying applications.

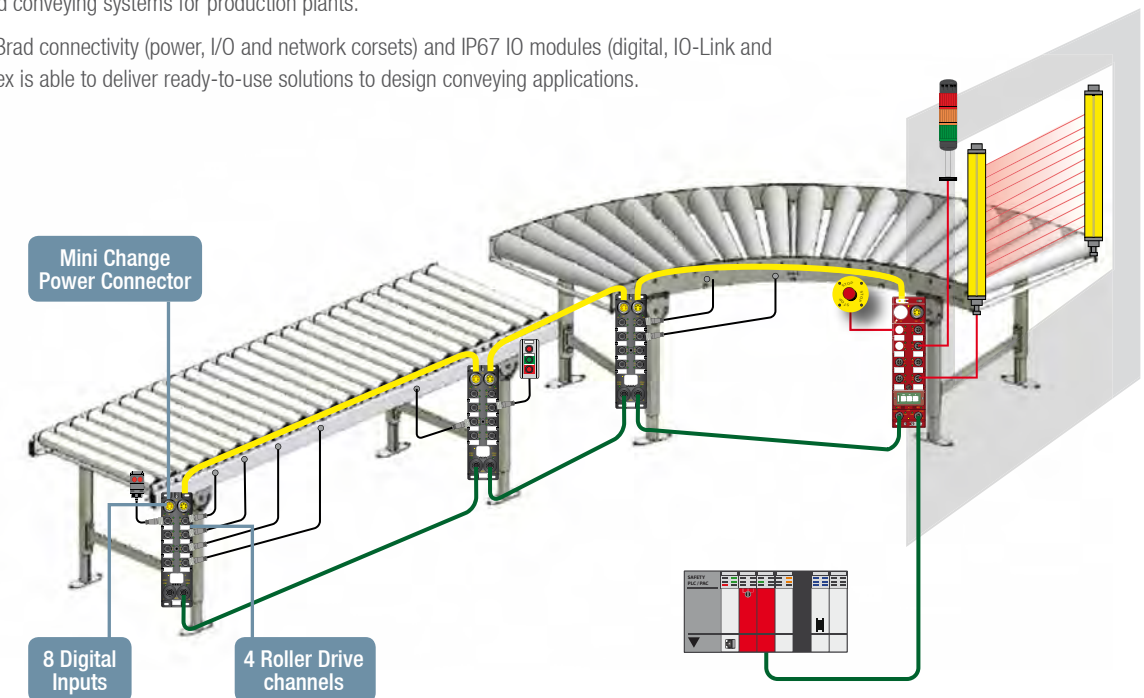

* Ethernet/IP is a trademark of the Open DeviceNet Vendor Association (ODVA).

⁽¹⁾PROFINET is a trademark of the PROFINET International (PI).

‡ One 9A external fuse is required in front of the module input power supply. In the case of daisy-chained modules, the external fuse shall still be located in front of every module.

‡ Depending on the application and configuration requirements.

Brad HarshIO Safety Solutions

molex

Brad HarshIO Safety Modules provide a reliable solution for developing safety applications in harsh duty environments up to EN 61508 SIL3, PLe according to ISO 13849-1.

HarshIO modules provide inputs and outputs connectivity to safety sensors and actuators – ideal for automotive applications controlling robots into cells as well as complex machine builders.

HarshIO Modules Benefits

- Rugged housing – Module is potted with resin and use metallic connectors
- Compact design delivers enhanced space savings and simplifies retrofit applications
- Extend temperature range from -20° up to +70°C with no electrical derating
- 4-pole and 5-pole power connector versions
- Overmolded memory key - Stores the module's configuration. Speeds up module replacement while eliminating special tools or recommissioning
- Ethernet Media Redundancy (DLR) and daisy-chaining
- USB stick – including safety manual, configuration software, EDS ... - with product package

HarshIO I/O safe capabilities

- TÜV certified: for use in safety applications, up to SIL3 and PLe
- Flexibility: supports connection of single and dual channel safety devices on inputs and outputs
- Individual Test Outputs: each test output can be assigned to a safety input device, allowing for optimized cable installations
- Safe sourcing outputs (1A) or safe bipolar outputs (2A) module versions
- Versatility: can connect to both standard and safety-rated sensors
- Advanced capabilities: reuse Test Outputs for added diagnostics, panel lamps, standard actuators, etc. and connect standard proximity switches, sensors and pushbuttons to unused safety inputs



SNCT - Configuration Software



Fast and easy solution for your HarshIO Safety module commissioning and diagnostic.

Advanced features like online device discovery, copy and paste SNN, Signature to and from RSLogix 5000, safety lock, password protection. SNCT is delivered with the product package.

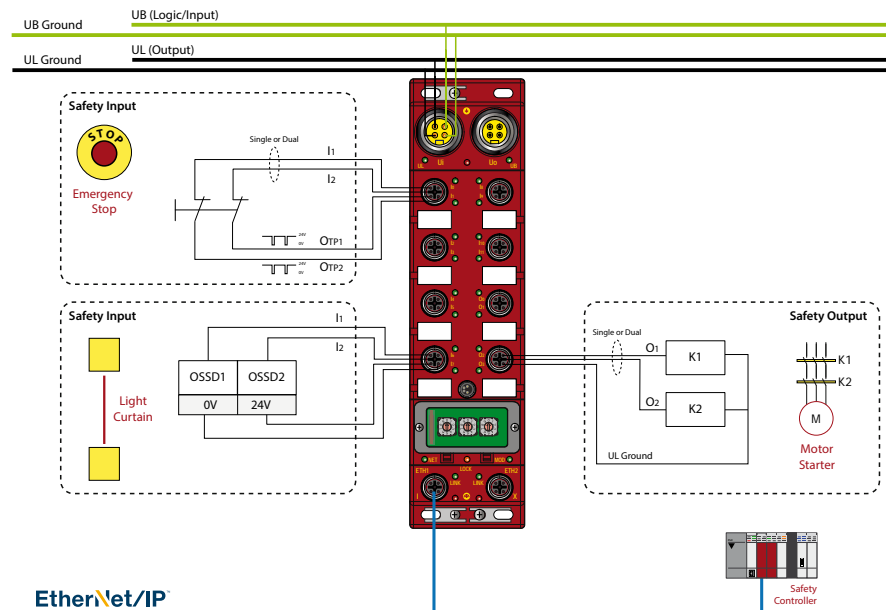

Brad HarshIO Safety Solutions

molex

Safety Plug and Play infrastructure solution

To simplify the integration of a high diversity of safety devices, Molex provides a range of Safety Passive components as adapters and splitters, for dedicated manufacturer and wiring standards.

An overview of the solutions available is listed in the Safety Integration Manual of our IO module or can be found on the Molex web site: www.molex.com/link/brad_support.html

Adapters and splitters for dedicated interconnection

Adapter cordsets convert different pinout to the standard Safety HarshIO port configuration through wire crossing or wire bridging.

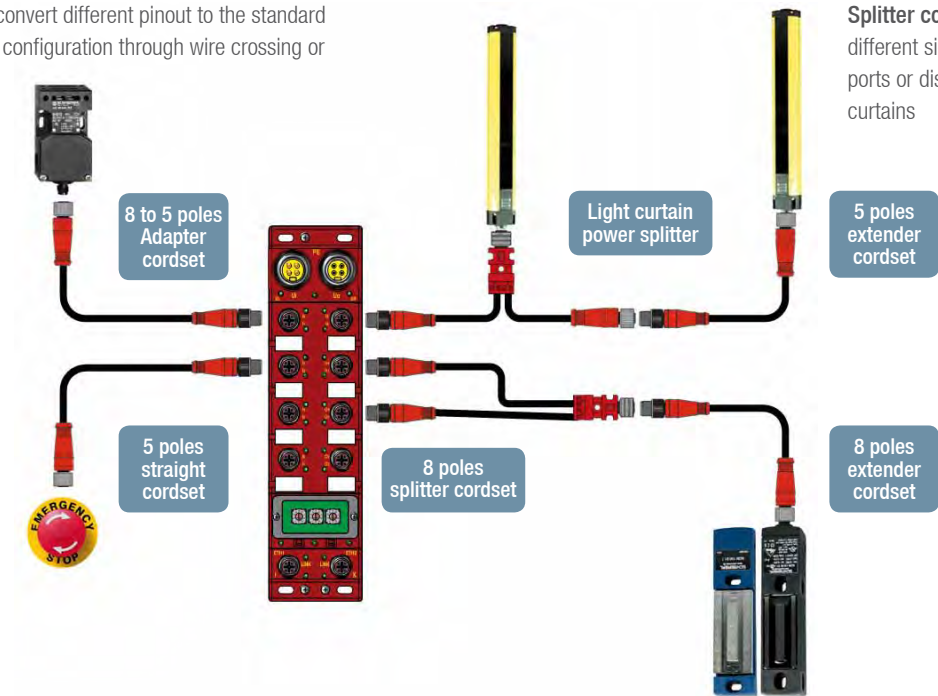

Splitter cordsets allow to dispatch different signals from sensors to multiple ports or distribute power in case of light curtains

Increase input sensors by serialisation

Safety Tee and Safety MPIS (Multiport Passive Interconnection Systems) allow to integrate several sensors in a single safety loop. Different wiring are available according to the safety signals (N.O., N.C., OSSD, ...)

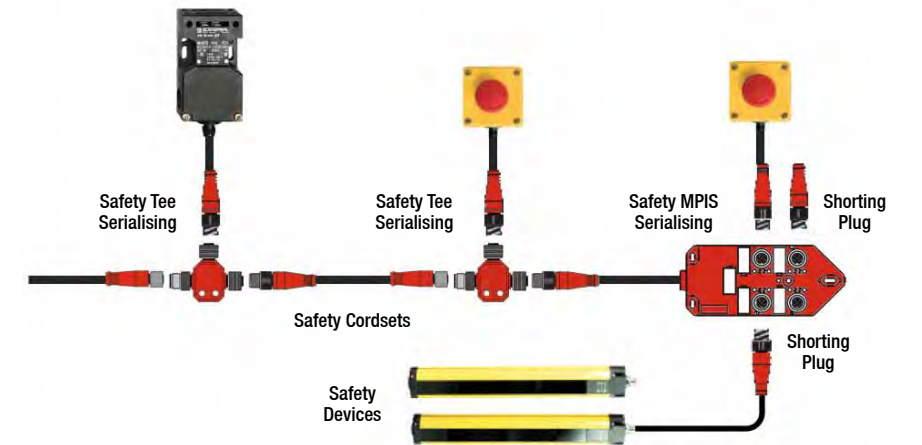

Safe control of multiple output signals

Power supply cordset adapters supply with power further automation equipment or digital outputs signals through one single Safe Output.

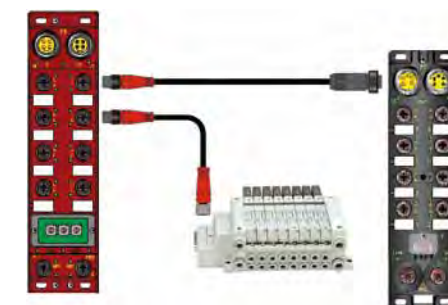

Flamar Cable Solutions for industrial automation applications

molex

Selecting the right cable for your application is very important to ensure a reliable and problem-free installation.

Careful consideration of mechanical abrasion, fluid/chemical exposure, flexibility (C-track, torsion), temperature resistance and flame retardancy requirements is required to select the cable that will provide performance and reliability in service.

Flamar from Molex

Flamar, a Molex company since 2014, proposes a brand new set of cables designed to cover the broadest range of applications for machine builders and system integrators:

- **Signal & Control:** to connect sensors, actuators, valves and distribution boxes
- **Servo Motor:** for power and encoder/resolver connection
- **Network:** for I/O modules and connection to PLC
- **Hybrid:** composite multicore cables whenever an extremely compact solution is required



Jacket choice for most demanding industrial application

- **PVC:** The most cost-effective solution for flexible and static installation.
- **WSOR:** Weld-Slag and Oil-Resistant Cable, a single-cable solution designed to withstand the severe environments found in automotive and industrial factory floors. Suitable for drag chain applications.
- **PUR (Polyurethane):** Ensures top mechanical performance, withstands harsh environments, abrasion resistant. PUR Jacket are halogen free. Suitable for drag chain applications
- **TPE:** Cables defined according to the US/Canadian market requirements (UL «PLTC»). Suitable for drag chain application.

3 Packaging Sizes

Each application section of the Brad Core Brochure includes the ordering number in Small, Medium and Large cable spool corresponding to the cable code from the Brad cordset engineering numbers.

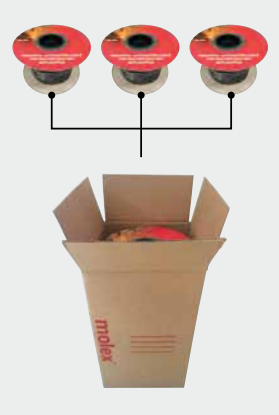
More cable choice on www.molex.com/flamar

Small	Medium	Large
3x100m - 3x200m* 3 cardboard reels inside one box	250m - 800m* 1 plywood reel	500m - 1500m* 1 wooden drum
		

Signal & Control



Servo Motor



Network



Hybrid



Weld-Slag and Oil-Resistant (WSOR) – the single-cable solution

molex



Extended characteristics and resistance

- **Withstands severe conditions in harsh environments:** Weld-slag and oil-resistant outer jacket cable. Meets UL 758/1581 and VDE 472-803/B specifications for harsh environment applications. Hydrolysis resistant (EN50396); UV resistant (UL1581-300h); tear resistant (EN50396)
- **Multiple design options in drag-chain applications:** Highly flexible cables with bend radius specifications of 5x outside diameter for static and 7.5x outside diameter for dynamic and drag chain conditions
- **Wide temperature ranges:** static -40 to +90°C, dynamic -25 to +80°C and drag-chain -5 to +60°C
- **Ensures safety for out-of-the-cabinet use:** Certified flame retardant according to IEC 60332-1, CSA FT1, UL Vertical Flame Test, UL AWM Style 21215 / CSA
- **ECOLAB compatible:** resistant to detergents, disinfectants and wash down water-jet used in Food & Beverage.

One solution for various applications

- **Available in a large cross-section offering:** 0.25, 0.34, 0.50, 0.75, 1.00, 1.50 and 2,50mm² (AWG 24 to AWG 14) for use in a variety of applications, from sensors and valves to servo motors and networks.
- **Suitable to a variety of industry-standard connectors:** available over molded with M8, M12, MiniChange (7/8"), M23 standard connectors for quick and reliable installation in the field or to be combined with Molex field attachable connectors for increased flexibility.
- **Designed for use in multiple markets:** in the automotive and robotic area, from welding to cutting-oil environments, conveying and most machine applications.

Optimized and cost effective connectivity solution

As manufacturer of this cable range, Molex can control quality and cost at every steps of the cordsets production to provide price effective cordsets. Choosing this polyvalent WSOR cable helps also to reduce inventory costs. The WSOR cable can also be purchased raw by Molex for the termination on site.



Flamar Standard Cables for Industrial Automation Brochure



English

987651-3992



Chinese

987651-4141



* Depending on cable diameter



Network Infrastructure components

Ethernet and Mini-Change (7/8") Power Distribution Architecture



Ethernet in combination with the industrial protocols like PROFINET or EtherNet/IP provide deterministic behavior for machine and process control applications with standard components.

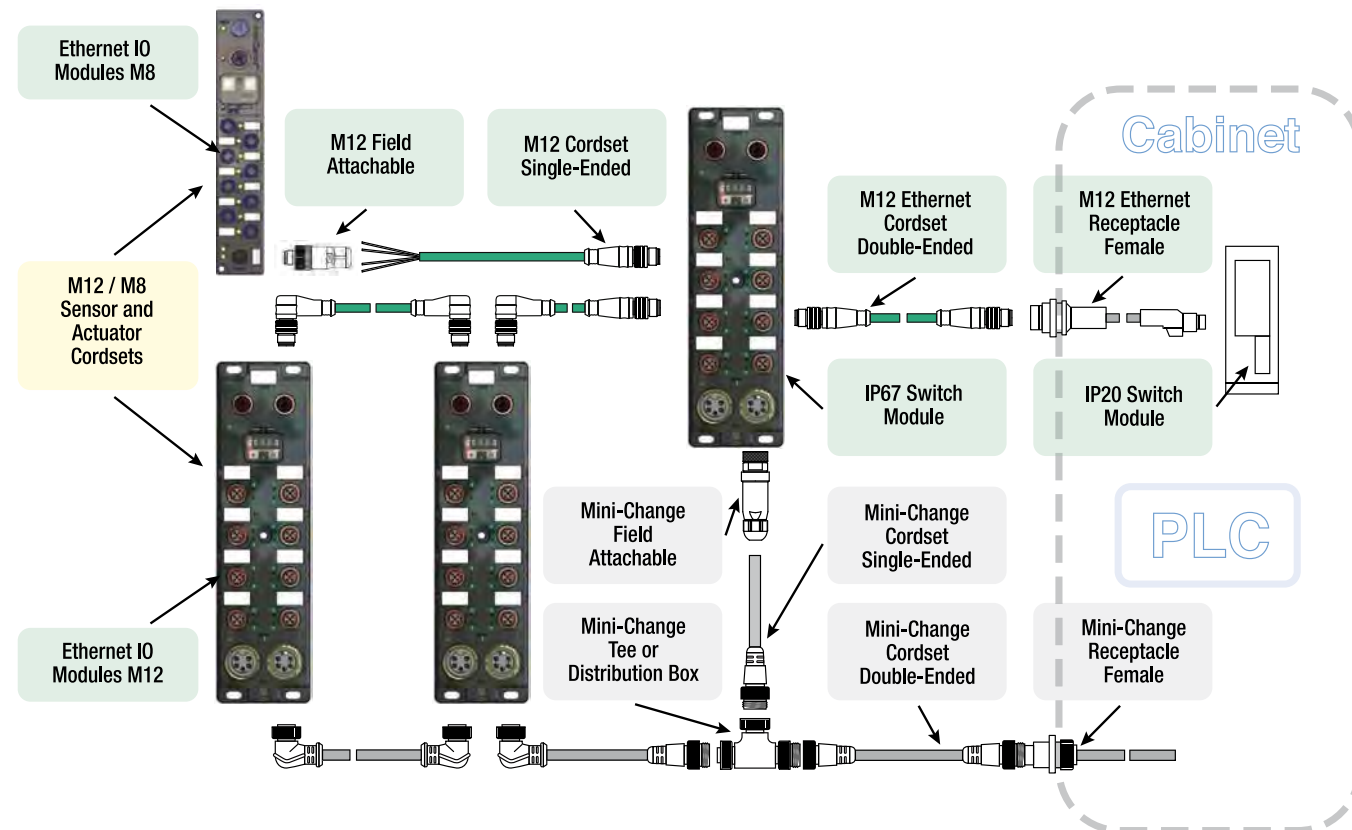

Brad EtherNet/IP IO-Link Classic HarshIO Modules

molex

Brad HarshIO IP67 IO-Link modules bring versatility and cost saving when designing complex machines in harsh environments.

Specifications

EtherNet/IP Adapter
 8x I/O-Link Master: Port Class A, v1.1 and v1.0 compatible
 8x I/O User Configurable
 IP address via rotary: DHCP, Static Address, and 0xF5/0xF6 objects
 Real-Time I/O update, up to 1ms
 Services: Automatic Conflict Detection (ACD),
 Web server including IO-Link diagnostic
 Inverter input setting per channel (DI)
 Fallback output behavior setting per channel (DO)
 Power supply monitoring (under and over voltage)
 General Diagnostic bit for quick health monitoring
 Operating Temperature: -25 to 70°C
 Storage Temperature: -40 to +85°C
 Approvals: CE, RoHS, REACH, cULus / CSA 22.2, ODVA Certified

User manual and description files to download under:
www.molex.com/link/brad_support.html



EtherNet/IP IO-Link

Brad EtherNet/IP Digital Classic HarshIO Modules

molex

IP67 rated digital IO modules for harsh environments are designed for direct machine mount applications with EtherNet/IP communication capabilities.

Specifications

EtherNet/IP Adapter
 IP address: DHCP, Static Address, and 0xF5/0xF6 objects Real-Time
 I/O update, up to 1 ms
 Services: Automatic Conflict Detection (ACD),
 QuickConnect < 500ms (QC Class A device)
 EDS configuration file (downloadable via CIP File Service)
 Embedded display for diagnostic
 Grounding isolation ⁽¹⁾ between Input/logic and Output Power
 Operating Temperature: -25 to +70°C
 Storage Temperature: -40 to +90°C
 Approvals: CE, UL, cUL, RoHS, REACH, ODVA Certified

User manual and description files to download under:
www.molex.com/link/brad_support.html



EtherNet/IP

Brad HarshIO IP67 EtherNet/IP Module – 60mm M12

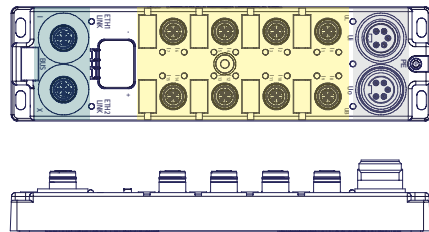

Connectivity

Ethernet: 2x Female M12 4P D-code Built-in 2 port switch Ultra-Lock® compatible	Inputs/Outputs: 8x Female M12 5P A-code Dual IO_Link (Pin4) and IO signal (Pin2) per port Inputs 24V max. 1.6A Outputs 24V max. 2A Ultra-Lock® compatible	Power: 1x Male 7/8" 4 or 5 Pole 1x Fem. 7/8" 4 or 5 Pole Voltage: 24V Input & Output, max. 8 Amps
--	--	---

Power Type	Input/Output (PNP)	Engineering No.	Standard Order No.
7/8" 5 Pole	8 IO-Link / 8 User Config.	TCIEI-888P-D1U	1120955121
7/8" 4 Pole	8 IO-Link / 8 User Config.	TCIEI-888P-DYU	1120955122

Brad HarshIO IP67 EtherNet/IP Module – 60mm M12

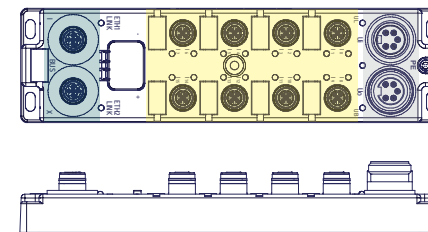

Connectivity

Ethernet: 2x Female M12 4P D-Code Built-in 2 port switch Ultra-Lock compatible	Inputs/Outputs: 8x Female M12 5P A-Code Dual IO signal per port Inputs 24V max. 140mA Outputs 24V max. 2A Ultra-Lock compatible	Power: 1x Male 7/8" 4 or 5 Pole 1x Fem. 7/8" 4 or 5 Pole Voltage: 24V Input & Output, max. 8 Amps
--	---	---

Power Type	Input/Output (PNP)	Engineering No.	Standard Order No.
7/8" 4 Pole ⁽¹⁾	16I	TCDEI-8D0P-DYU-G02	1120955137
	8I/8O	TCDEI-888P-DYU-G02	1120955138
	12I/4O	TCDEI-8B4P-DYU-G02	1120955139
	16O	TCDEI-80DP-DYU-G02	1120955140
	User Config.	TCDEI-8YYX-DYU-G02	1120955116
7/8" 5 Pole	User Config.	TCDEI-8YYX-D1U-G02	1120955117

(1) Not available on User Configurable IO model.

Brad EtherNet/IP Digital Compact HarshIO Modules

molex

The compact 30mm wide version is designed to be installed in narrow areas and is perfect for packaging and pick-and-place applications. The lower port count of this model provides a cost-effective module.



EtherNet/IP

Specifications

EtherNet/IP Adapter
 IP addressing: DHCP, Static Address, and 0xF5/0xF6 objects
 Real-Time I/O update, up to 1 ms
 Services: Automatic Conflict Detection (ACD)
 EDS configuration file (downloadable via CIP File Service)
 Power Operating Temperature: -25 to 70°C
 Storage Temperature: -40 to +90°C
 Approvals: CE, UL, cUL, RoHS, REACH, ODVA Certified

User manual and description files to download under:
www.molex.com/link/brad_support.html

Brad HarshIO IP67 EtherNet/IP Module – 30mm M8

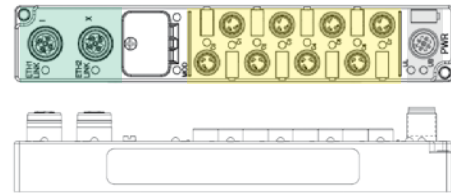

Connectivity		
Ethernet: 2x Female M12 4P D-Code Built-in 2 port switch Ultra-Lock compatible	Inputs/Outputs: 8x Female M8 3 Poles Single IO signal per port Inputs 24V max. 140mA Outputs 24V max. 1,4A	Power: 1x Male M12 5 Pole A-Code Voltage: 24V Input & Output, max. 4 Amps

Power Type	Input/Output (PNP)	Engineering No.	Standard Order No.
M12 5 Pole	User Config.	TBDEI-8YYP-D84	1120955071

Brad HarshIO IP67 EtherNet/IP Module – 30mm M12

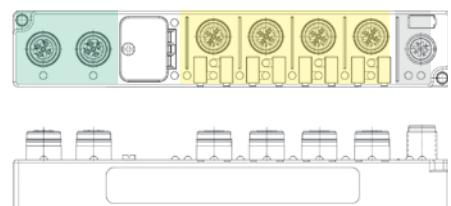

Connectivity		
Ethernet: 2x Female M12 4P D-Code Built-in 2 port switch Ultra-Lock compatible	Inputs/Outputs: 4x Female M12 5P A-Code Dual IO signal per port Inputs 24V max. 140mA Outputs 24V max. 1,4A Ultra-Lock compatible	Power: 1x Male M12 5 Pole A-Code Voltage: 24V Input & Output, max. 4 Amps

Power Type	Input/Output (PNP)	Engineering No.	Standard Order No.
M12 5 Pole	User Config.	TBDEI-4YYP-D8U	1120955083

Brad EtherNet/IP CIP Safety Classic HarshIO Modules

molex

Brad HarshIO IP67 Modules for EtherNet/IP featuring CIP Safety technology deliver significant operational advantages of protection and versatility for industrial safety applications.



EtherNet/IP



Specifications

EtherNet/IP CIP Safety IO Adapter
 For use in safety applications, up to SIL3 and PLe; Mission time > 20 years
 Real-Time I/O update, up to 10 ms
 Output Bipolar version: max. 2A per dual channel
 Support ODVA CIP Safety I/O generic profiles
 Services: Automatic Conflict Detection (ACD), DLR Client
 EDS upload file (downloadable via CIP File Service)
 Integrated Web server for diagnostics
 IP address: DHCP, Static Address and EtherNet/IP 0xF5/0xF6 objects
 Grounding isolation between Input/logic and Output Power
 Easy commissioning thanks to Molex SNCT software and RA RSLogix™ 5000
 Memory Key for configuration storage: External (M8) or Internal (Window)
 Operating Temperature: -25 to +70°C
 Storage Temperature: -40 to +90°C
 Approvals: CE, UL, cUL, Rohs, REACH, TUV(2), ODVA Certified

User manual and description files to download under:
www.molex.com/link/brad_support.html

Brad HarshIO IP67 EtherNet/IP CIP Safety

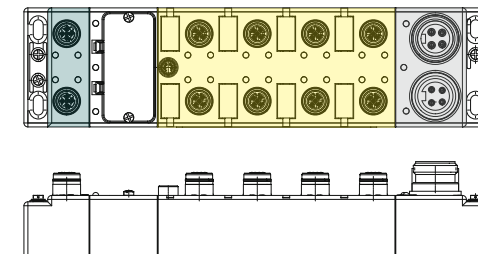

Connectivity		
Ethernet: 2x Female M12 4P D-code Built-in 2 port switch Ultra-Lock® compatible	Inputs/Outputs: 8x Female M12 5P A-Code Dual IO signal per port Inputs 24V max. 140mA Outputs 24V max. 2A Ultra-Lock® compatible	Power: 1x Male 7/8" 4 or 5 Pole 1x Fem. 7/8" 4 or 5 Pole Voltage: 24V Input & Output, max. 8 Amps

Power Type	Input/Output (PNP)	Engineering No.	Standard Order No.
with external M8 configuration memory			
7/8" 5 Pole	12V/40	TCDEC-8B4P-D1U-G8	1120955129
	12V/40 (Bipolar)	TCDEC-8B4B-D1U-G8	1120955130
7/8" 4 Pole (1)	12V/40	TCDEC-8B4P-DYU-G8	1120955127
	12V/40 (Bipolar)	TCDEC-8B4B-DYU-G8	1120955128
with internal window configuration memory			
7/8" 5 Pole	12V/40	TCDEC-8B4P-D1U-GW	1120955111
	12V/40 (Bipolar)	TCDEC-8B4B-D1U-GW	1120955112
7/8" 4 Pole (1)	12V/40	TCDEC-8B4P-DYU-GW	1120955107
	12V/40 (Bipolar)	TCDEC-8B4B-DYU-GW	1120955108

Brad EtherNet/IP MDR Conveyor Classic HarshIO Modules

molex



EtherNet/IP

Brad HarshIO modules provide a unique and reliable solution for interfacing logic controllers (PLC/PAC) with conveyor Motorized Drive Rollers (MDR's) in harsh environments.

Specifications

EtherNet/IP Adapter
 8x Digital Inputs/Outputs user configurable
 Auto-detection of INTERROLL EC310 and ITOH DENKI PM500XE/XP MDR's
 Active MDR protection and integrated predictive maintenance
 IP address: DHCP, Static Address, and 0xF5/0xF6 objects
 Real-Time I/O update up to 1 ms
 Services: Automatic Conflict Detection (ACD)
 EDS configuration file (downloadable via CIP File Service)
 Grounding isolation between Input/logic and Output Power Operating
 Temperature: -30 to +50°C
 Approvals: CE, UL, cUL, RoHS, REACH, ODVA Certified

User manual and description files to download under:
www.molex.com/link/brad_support.html

Brad HarshIO IP67 EtherNet/IP Module – 60mm M12

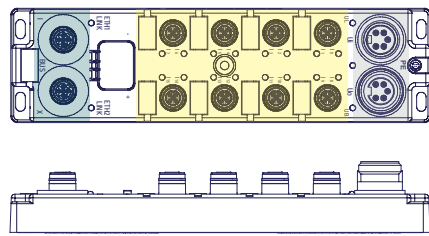

Connectivity

Ethernet: 2x Female, M12, 4P, D-code, Ultra-Lock® compatible Built-in 2 port switch	Inputs/Outputs: 8x Female M12 5P A-code Inputs 24V max. 140mA Outputs 24V max. 2A Ultra-Lock® compatible	Power: 1x Male 7/8" 4 or 5 Pole 1x Fem. 7/8" 4 or 5 Pole Voltage: 24V Input & Output, max. 9 Amps
--	--	---

Power Type	Input/Output (PNP)	Engineering No.	Standard Order No.
7/8" 5 Pole	8I/4O/ 4 Motor Drive	TCDEI-88MP-D1U-G	1120955118

Brad PROFINET IO-Link Classic HarshIO Modules

molex



PROFINET® IO-Link

Brad HarshIO IP67 IO-Link modules brings versatility and cost saving when designing complex machines in harsh environments.

Specifications

PROFINET IO-Device v2.3 Conformance class B
 8x IO-Link Master: Port Class A, v1.1 and v1.0 compatible
 8x IO User Configurable
 IP addressing: DCP or static
 Real-Time I/O update, up to 1ms
 Services: SNMP V1/V2/V3, LLDP Send/Rec, MRP, I&M, Easy Device replacement, Netload: Class 1
 Web server including IO-Link diagnostic
 Inverter input setting per channel (DI)
 Fallback output behavior setting per channel (DO)
 Power supply monitoring (under and over voltage)
 General Diagnostic bit for quick health monitoring
 Operating Temperature: -25 to 70°C
 Storage Temperature: -40 to +85°C
 Approvals: CE, RoHS, REACH, cULus / CSA 22.2, PI Certified

User manual and description files to download under:
www.molex.com/link/brad_support.html

Brad HarshIO IP67 PROFINET – Module 60mm M12

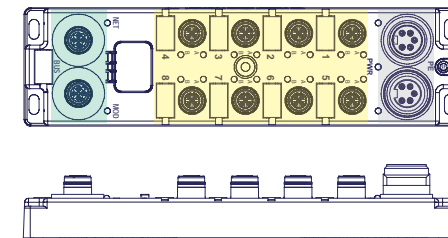

Connectivity

Ethernet: 2x Female M12 4P D-code Built-in 2 port switch Ultra-Lock® compatible	Inputs/Outputs: 8x Female M12 5P A-code Dual IO_Link (Pin4) and IO signal (Pin2) per port Inputs 24V max. 1.6A Outputs 24V max. 2A Ultra-Lock® compatible	Power: 1x Male 7/8" 5 Pole 1x Fem. 7/8" 5 Pole Voltage: 24V Input & Output, max. 8 Amps
--	--	---

Power Type	Input/Output (PNP)	Engineering No.	Standard Order No.
7/8" 5 Pole	8 IO-Link / 8 User Config.	TCIEP-888P-D1U	1120955119

Brad PROFINET Digital Classic HarshIO Modules

molex

IP67 rated digital IO modules for harsh environments are designed for direct machine mount applications with PROFINET IO communication capabilities.

Specifications

PROFINET IO-Device, Conformance class B
 IP addressing: DCP or static
 Real-Time I/O update, up to 1 ms
 Services: PROFIenergy, SNMP V1/V2/V3, LLDP Send/Rec, MRP, I&M, Easy Device replacement, Fast Start-Up (FSU) < 500ms
 GSDML configuration file (downloadable via integrated Web server) Embedded display for diagnostic
 Grounding isolation between Input/logic and Output Power(1)
 Operating Temperature: -25 to 70°C
 Storage Temperature: -40 to +90°C
 Approvals: CE, UL, cUL, RoHs, REACH, PNO Certified

User manual and description files to download under:
www.molex.com/link/brad_support.html



Brad® HarshIO IP67 PROFINET Module 60mm M12

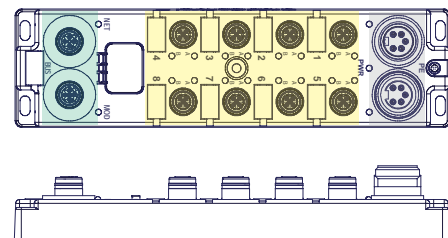

Connectivity

Ethernet: 2x Female M12 4P D-code Built-in 2 port switch Ultra-Lock® compatible	Inputs/Outputs: 8x Female M12 5P A-code Dual IO signal per port Inputs 24V max. 140mA Outputs 24V max. 2A Ultra-Lock® compatible	Power: 1x Male 7/8" 4 or 5 Pole Voltage: 24V Input 8 Amps
---	--	--

Power Type	Input/Output (PNP)	Engineering No.	Standard Order No.
7/8" 5 Pole	16I	TCDEP-8D0P-D1U-G	1120955048
	8I/8O	TCDEP-888P-D1U-G	1120955050
	12I/4O	TCDEP-8B4P-D1U-G	1120955051
	16O	TCDEP-80DP-D1U-G	1120955049
User Config.	TCDEP-8YXX-D1U-01	1120955115	

(1) Not available on User Configurable IO model
 For more information consult our web page or industrial automation catalog.

Brad PROFINET Digital Compact HarshIO Modules

molex

The compact 30mm wide version is designed to be installed in narrow areas and is perfect for packaging and pick-and-place applications. The lower port count of this model provides a cost-effective module.

Specifications

PROFINET IO-Device, Conformance class B
 IP addressing: DCP or static
 Real-Time I/O update, up to 1 ms
 Services: SNMP V1/V2/V3, LLDP Send/Rec, I&M, Easy Device replacement, Fast Start-Up (FSU) < 500ms
 Power Operating Temperature: -25 to 70°C
 Storage Temperature: -40 to +90°C
 Approvals: CE, UL, cUL, RoHs, REACH, PNO Certified

User manual and description files to download under:
www.molex.com/link/brad_support.html



Brad HarshIO IP67 PROFINET Module – 30mm M8

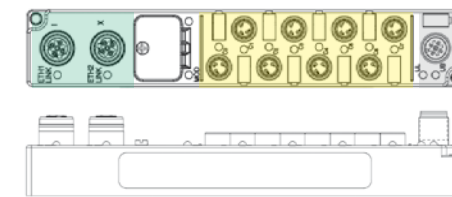

Connectivity

Ethernet: 2x Female M12 4P D-Code Built-in 2 port switch Ultra-Lock® compatible	Inputs/Outputs: 8x Female M8 3 Poles Single IO signal per port Inputs 24V max. 140mA Outputs 24V max. 1.4A	Power: 1x Male M12 5 Pole A-Code Voltage: 24V Input & Output, max. 4 Amps
---	--	---

Power Type	Input/Output (PNP)	Engineering No.	Standard Order No.
M12 5 Pole	8I	TBDEP-880P-D84-G	1120955064
	4I/4O	TBDEP-844P-D84-G	1120955065
	8O	TBDEP-808P-D84-G	1120955066
	User Config.	TBDEP-8YYP-D84	1120955067

Brad HarshIO IP67 PROFINET Module – 30mm M12

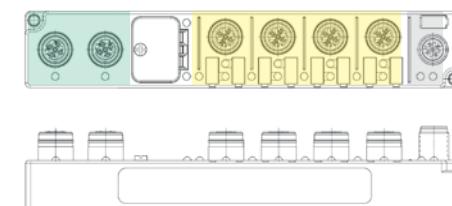

Connectivity

Ethernet: 2x Female M12 4P D-Code Built-in 2 port switch Ultra-Lock® compatible	Inputs/Outputs: 4x Female M12 5P A-Code Dual IO signal per port Inputs 24V max. 140mA Outputs 24V max. 1.4A Ultra-Lock compatible	Power: 1x Male M12 5 Pole A-Code Voltage: 24V Input & Output, max. 4 Amps
---	---	---

Power Type	Input/Output (PNP)	Engineering No.	Standard Order No.
M12 5 Pole	8I	TBDEP-480P-D8U-G	1120955076
	4I/4O	TBDEP-440P-D8U-G	1120955077
	8O	TBDEP-408P-D8U-G	1120955078
	User Config.	TBDEP-4YYP-D8U	1120955079

Brad PROFINET MDR Conveyor Classic HarshIO Modules

molex



Brad HarshIO modules provide a unique and reliable solution for interfacing logic controllers (PLC/PAC) with conveyor Motorized Drive Rollers (MDR's) in harsh environments

Specifications

PROFINET IO-Device, Conformance class B
 8x digital input/output user configurable
 Auto-detection of INTERROLL EC310 and ITOH DENKI PM500XE/XP MDR's
 Active MDR protection and integrated predictive maintenance
 IP address: DCP or Static
 Real-Time I/O update up to 1 ms
 Services: SNMP V1/V2/V3, LLDP Send/Rec, I&M, Easy Device replacement
 GSDML configuration file (downloadable via integrated web server)
 Grounding isolation between Input/logic and Output powers Operating Temperature: -30 to +50°C
 Approvals: CE, UL, cUL, RoHS, REACH, ODVA Certified

User manual and description files to download under:
www.molex.com/link/brad_support.html

Brad HarshIO IP67 PROFINET Module – 60mm M12

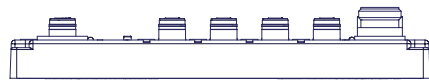
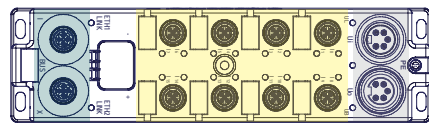

Connectivity

Ethernet: 2x Female, M12, 4P, D-code, Ultra-Lock compatible Built-in 2 port switch	Inputs/Outputs: 8x Female M12 5P A-code Inputs 24V max. 140mA Outputs 24V max. 2A Ultra-Lock compatible	Power: 1x Male 7/8" 5 Pole 1x Fem. 7/8" 5 Pole Voltage: 24V Input & Output, max. 9 Amps
---	--	---

Power Type	Input/Output (PNP)	Engineering No.	Standard Order No.
7/8" 5 Pole	8 User Config. + 4 MDR	TCDEP-8YMP-D1U-G	1120955158

Brad DeviceNet HarshIO Modules

molex



IP67 rated digital IO modules for harsh environments are designed for direct machine mount applications with DeviceNet communication capabilities.

Specifications

DeviceNet Slave Supports ADR and Quick-Connect
 Auto baud: all baud rates up to 500k Baud
 Address Settings: 1 - 99 by rotary switches
 Operating Temperature: -25 to +70°C
 Storage Temperature: -40 to +90°C
 Approvals: CE, UL, ODVA Certification

User manual and ESD files to download under:
www.molex.com (select Brad Automation Products Support Center)

Brad HarshIO IP67 DeviceNet Module – 60mm M12

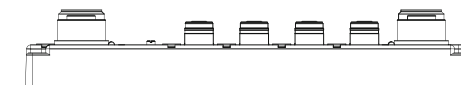
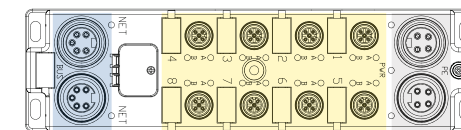

Connectivity

DeviceNet: 1x Male 7/8" 5 Poles 1x Female 7/8" 5 Poles	Inputs/Outputs: 8x Female M12 5 Poles A-code Dual IO signal per port Inputs 24V max. 140mA Outputs 24V max. 1A	Power: 1x Male 7/8" 4 Poles 1x Female 7/8" 4 Poles Voltage 24V Input & Output, max. 8 Amps
---	--	--

Power Type	Input/Output (PNP)	Engineering No.	Standard Order No.
7/8" 4 Pole	16I	TCDDN-8DOP-10U	1120920010
	8I/8O	TCDDN-888P-11U (A)	1120925011

Brad HarshIO IP67 DeviceNet Module – 30mm M8

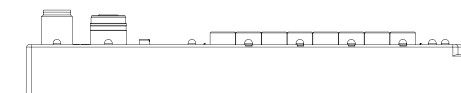
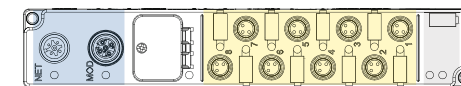

Connectivity

DeviceNet: 1x Male M12 5 Poles A-code 1x Female M12 5 Poles A-code	Inputs/Outputs: 8x Female M8 3 Poles Single IO signal per port Inputs 24V max. 140mA	Power: 24V Input via DeviceNet bus power
---	---	--

Power Type	Input/Output (PNP)	Engineering No.	Standard Order No.	
DeviceNet Bus Power	PNP	8I	TBDDN-880P-804	1120920008

Brad IO-Link HarshIO Devices

Brad IO-Link infrastructure accessories are enhancing the I/O count capabilities and the modularity of the Brad IO-Link HarshIO module.

Specifications

Brad IO-Link Digital I/O Hubs – 60 mm M12

IO-Link COM3 communication Version 1.1
 Max. Cycle Time: 1ms
 IO-Link process Data length
 Module Current consumption: 40mA
 Max Input current load 100mA (port)
 Max Output current load 0.5A
 UB - Pin 1/3: Power supply for electronics and Inputs
 UL - Pin 2/3: Extended Power supply for outputs or optionally for inputs (configurable)
 Operating temperature: -25 to +70°C
 Storage temperature: -40 to +90°C
 Approvals: CE, UL, cUL, RoHS, REACH

To connect IO-Link Digital I/O Hubs to IO-Link Master HarshIO use standard M12 Sensor/Actuator 4 pole cordsets



Connectivity

IO-Link: 1x Male M12 5P A-Code Pin4: IO-Link device comm Pin2: Extended power supply	Inputs/Outputs: 8x Female M12 5P A-Code Dual IO signal per port. Inputs 24v, max 100mA Outputs 24V, max 2A
--	---

molex



IO-Link

Brad Harsh-Duty Ethernet Switches

IP67 rated fast Ethernet switches for harsh environments are designed for direct machine mount applications.

Specifications

Unmanaged IP67 switches
 Compatible with PROFINET and EtherNet/IP systems
 Speed 10/100Mbps auto negotiation, full or half duplex
 Auto-learning with no software or configuration required
 Operating Temperature: -40 to +75°C
 Storage Temperature: -40 to +90°C
 Approvals: CE, UL, cUL



molex

EtherNet/IP[®] PROFINET[®]

Brad Harsh-Duty Unmanaged IP67 Ethernet Switch – 60mm M12

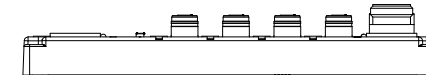
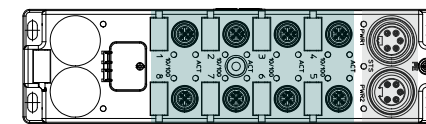

Connectivity

Ethernet: 8x Female M12 4P D-Code Ultra-Lock [®] compatible	Power: 1x Male 7/8" or 1x Male M12 4 or 5 Pole 1x Fem. 7/8" or 1x Fem. M12 4 or 5 Pole Dual power supply entry, 9-36VDC
---	--

Power Type	Engineering No.	Standard Order No.
7/8" 5 Pole	DRL-780	1121055002
7/8" 4 Pole	DRL-781	1121055004
M12 5 Pole	DRL-782	1121055006

Brad Harsh-Duty Unmanaged IP67 Ethernet Switch – 30mm M12

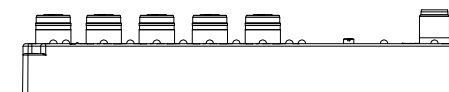
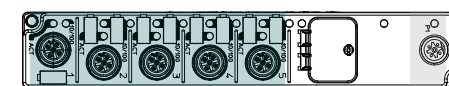

Connectivity

Ethernet: 5x Female M12 4P D-Code	Power: 1x Male M12 5 Pole 9-36VDC
---	--

Power Type	Engineering No.	Standard Order No.
M12 5 Pole	DRL-750	1121115001

Brad EtherNet/IP Infrastructure Connectivity

molex

EtherNet/IP

Plug & Play infrastructure to interconnect CAT5e Ethernet IP67 devices based on 4 Pole D-Code M12 standard connectors.

Brad EtherNet/IP Double-Ended Male to Male M12 Cordsets (D-Code)



Length	EtherNet/IP Unshielded PVC Cable 02 - Teal		EtherNet/IP Unshielded TPE Cable 04 - Teal	
	Engineering No.	Standard Order No.	Engineering No.	Standard Order No.
0,3m	E11A06002M003	1200490557	E11A06004M003	1300480251
0,5m	E11A06002M005	1300480084	E11A06004M005	1300480262
1m	E11A06002M010	1200490417	E11A06004M010	1300480095
2m	E11A06002M020	1200490490	E11A06004M020	1300480096
3m	E11A06002M030	1201080027	E11A06004M030	1300480097
4m	E11A06002M040	1300480222	E11A06004M040	1300480098
5m	E11A06002M050	1300480085	E11A06004M050	1300480099
10m	E11A06002M100	1201080038	E11A06004M100	1300480104
15m	E11A06002M150	1201080037	E11A06004M150	1300480107
20m	E11A06002M200	1201080036	E11A06004M200	1300480109
Length	EtherNet/IP Shielded PVC Cable 15 - Teal		EtherNet/IP Shielded WSOR Cable 16 - Teal	
	Engineering No.	Standard Order No.	Engineering No.	Standard Order No.
1m	E11A06015M010	1300480122	E11A06016M010	1201088420
2m	E11A06015M020	1300480124	E11A06016M020	1201088421
3m	E11A06015M030	1300480009	E11A06016M030	1201088422
5m	E11A06015M050	1300480126	E11A06016M050	1201088424
10m	E11A06015M100	1300480128	E11A06016M100	1201088427



EtherNet/IP M12 Male (D-Code) to RJ45 Plug Cordsets



Length	EtherNet/IP Unshielded PVC Cable 02 - Teal		EtherNet/IP Unshielded TPE Cable 04 - Teal	
	Engineering No.	Standard Order No.	Engineering No.	Standard Order No.
1m	E16A06002M010	1300480205	E16A06004M010	1300480309
2m	E16A06002M020	1300488005	E16A06004M020	1300480348
3m	E16A06002M030	1300480206	E16A06004M030	1300480349
5m	E16A06002M050	1300480248	E16A06004M050	1300480305
10m	E16A06002M100	1300480015	E16A06004M100	1300480306
Length	EtherNet/IP Shielded PVC Cable 15 - Teal		EtherNet/IP Shielded WSOR Cable 16 - Teal	
	Engineering No.	Standard Order No.	Engineering No.	Standard Order No.
1m	E16A06015M010	1300480280	E16A06016M010	1201088450
2m	E16A06015M020	1300488099	E16A06016M020	1201088451
3m	E16A06015M030	1300488195	E16A06016M030	1201088452
5m	E16A06015M050	1300488237	E16A06016M050	1201088454
10m	E16A06015M100	1300488101	E16A06016M100	1201088458



Brad EtherNet/IP Infrastructure Connectivity

molex

EtherNet/IP

EtherNet/IP RJ45 Plug to RJ45 Plug Cordsets



Length	EtherNet/IP Unshielded PVC Cable 02 - Teal		EtherNet/IP Unshielded TPE Cable 04 - Teal	
	Engineering No.	Standard Order No.	Engineering No.	Standard Order No.
0,5m	E66A06002M005	1201080009	E66A06004M005	1201080687
1m	E66A06002M010	1201080008	E66A06004M010	1201080557
2m	E66A06002M020	1201080007	E66A06004M020	1201080558
3m	E66A06002M030	1201080006	E66A06004M030	1201080559
5m	E66A06002M050	1201080004	E66A06004M050	1201080560
10m	E66A06002M100	1300480034	E66A06004M100	1201080561
Length	EtherNet/IP Shielded PVC Cable 15 - Teal		EtherNet/IP Shielded WSOR Cable 16 - Teal	
	Engineering No.	Standard Order No.	Engineering No.	Standard Order No.
0,5m	E66A06015M005	1201088264	E66A06016M005	1201088532
1m	E66A06015M010	1201088249	E66A06016M010	1201088474
2m	E66A06015M020	1201088250	E66A06016M020	1201088475
3m	E66A06015M030	1201088258	E66A06016M030	1201088476
5m	E66A06015M050	1201088251	E66A06016M050	1201088478
10m	E66A06015M100	1201088252	E66A06016M100	1201088482



EtherNet/IP Female M12 (D-Code) Receptacle to RJ45 Plug Cordsets

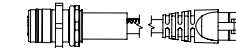

Length	EtherNet/IP Unshielded PVC Cable 02 - Teal (PG9 BPM)		EtherNet/IP Unshielded PVC Cable 02 - Teal (PG9 BPM)	
	Engineering No.	Standard Order No.	Engineering No.	Standard Order No.
0.5m	ERWPAB3002M005	1300540020	ERWPAB3004M005	1300580125
1m	ERWPAB3002M010	1300580025	ERWPAB3004M010	1300580124
2m	ERWPAB3002M020	1300540021	ERWPAB3004M020	1300580302
3m	ERWPAB3002M030	1300540022	ERWPAB3004M030	1300580126
4m	ERWPAB3002M040	1300540023	ERWPAB3004M040	1300580303
5m	ERWPAB3002M050	1300540024	ERWPAB3004M050	1300580304
Length	EtherNet/IP Unshielded TPE Cable 04 - Teal (M16 BPM)		EtherNet/IP Unshielded TPE Cable 04 - Teal (M16 BPM)	
	Engineering No.	Standard Order No.	Engineering No.	Standard Order No.
1m	ERWPAU7004M010	1201080675	ERWPAU7016M010	1201088499
2m	ERWPAU7004M020	1201080676	ERWPAU7016M020	1201088500



Brad EtherNet/IP Infrastructure Connectivity

molex

EtherNet/IP

Plug & Play infrastructure to interconnect CAT5e Ethernet IP67 devices based on 4 Pole D-Code M12 standard connectors.

EtherNet/IP Adapters (D-Code Female to RJ45 Jack)

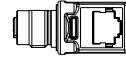
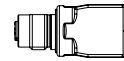

M12 Female Receptacle to Straight RJ45		M12 Female Receptacle to 90° RJ45	
Engineering No.	Standard Order No.	Engineering No.	Standard Order No.
ER1PADAPTER	1300540031	ER1PADAPTER90	1300540010

EtherNet/IP adaptors (D-Code female to D-Code female)



M12 Female to Female Bulkhead Receptacle	
Engineering No.	Standard Order No.
1200848170	1200848170

Brad EtherNet/IP Infrastructure Connectivity

molex

EtherNet/IP

EtherNet/IP M12 Shielded Field Attachable (D-Code)

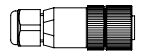
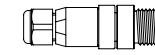

Poles	Cable Size	Wire Gauge	Wire Termination Style	Male Straight		Female Straight	
				Engineering No.	Standard Order No.	Engineering No.	Standard Order No.
4	6.0 - 8.0mm	<AWG 18	Screw	E1AS06-32	1300470035	E1AS00-32	1300470037
4	4.0 - 8.0mm	AWG 26-22	IDC	E1AS06-53	1300470039	E1AS00-53	1300470040

EtherNet/IP RJ45 Shielded Field Attachable



Poles	Cable Size	Wire Gauge	Wire Termination Style	Male Straight		Male 90°	
				Engineering No.	Standard Order No.	Engineering No.	Standard Order No.
8	5.5 - 9.0mm	AWG 24-22	IDC	E6AS06-5	1300478008	E6AS07-5	1300478009
8	5.5 - 9.0mm	AWG 26-24	IDC	E6AS06-6	1300478010	E6AS07-6	1300478011

Raw Cable

EtherNet/IP PVC Cable 02 - Teal		EtherNet/IP TPE Cable 04 - Teal	
Size	Standard Order No.	Size	Standard Order No.
500FT Boxed	1301340001	3x200m	1554408001
		1x800m	1554408002
		1x1500m	1554408003
EtherNet/IP Shielded PVC Cable 15 - Teal		EtherNet/IP Shielded WSOR Cable 16 - Teal	
3x200m	1554418001	3x100m	1554216007
1x800m	1554418002	1x500m	1554216008
1x1500m	1554418003	1x1000m	1554216009



This cable can also be used for any other Ethernet communication protocol

ETHERNET
POWERLINK
Ether**CAT**
MODBUS
TCP
EtherNet/IP

Brad CAT6A Ethernet M12 X-Code Infrastructure Connectivity

molex

EtherNet/IP

Plug & Play infrastructure to interconnect CAT6A Ethernet IP67 devices based on Shielded 8 Pole X-Code M12 standard connectors.

CAT6A Ethernet Double-Ended Male to Male M12 Cordsets (X-Code)



CAT6A EtherNet Shielded PUR Cable 20 - Teal		
Length	Engineering No.	Standard Order No.
0,5m	E22E06020M005	1203410300
1m	E22E06020M010	1203410301
2m	E22E06020M020	1203410302
3m	E22E06020M030	1203410303
5m	E22E06020M050	1203410305
10m	E22E06020M100	1203410306



CAT6A Ethernet M12 Male (X-Code) to RJ45 Plug Cordsets



CAT6A EtherNet Shielded PUR Cable 20 - Teal		
Length	Engineering No.	Standard Order No.
0,5m	E26E06020M005	1203410500
1m	E26E06020M010	1203410501
2m	E26E06020M020	1203410502
3m	E26E06020M030	1203410503
5m	E26E06020M050	1203410505
10m	E26E06020M100	1203410506



CAT6A Ethernet RJ45 Plug to RJ45 Plug Cordsets



CAT6A EtherNet Shielded PUR Cable 20 - Teal		
Length	Engineering No.	Standard Order No.
1m	E66E06020M010	1203410601
2m	E66E06020M020	1203410602
5m	E66E06020M050	1203410605
10m	E66E06020M100	1203410606



CAT6A Ethernet Female M12 (X-Code) Receptacle to RJ45 Plug Cordsets



CAT6A EtherNet Shielded PUR Cable 20 - Teal		
Length	Engineering No.	Standard Order No.
0,5m	ERWPEU7020M005	1203410750
1m	ERWPEU7020M010	1203410751
2m	ERWPEU7020M020	1203410752



Brad CAT6A Ethernet M12 X-Code Infrastructure Connectivity

molex

EtherNet/IP

Plug & Play infrastructure to interconnect CAT6A Ethernet IP67 devices based on Shielded 8 Pole X-Code M12 standard connectors.

CAT6A Ethernet M12 Female (X-Code) PCB Receptacles

Front Panel Mount (M16 Thread)		Back Panel Mount (M16 Thread)	
Engineering No.	Standard Order No.	Engineering No.	Standard Order No.
ER2D2U303	1203410075	ER2D2U703	1203410150



CAT6A Ethernet Adapters (X-Code Female to RJ45 Jack)

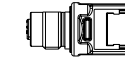

M12 Female (X-Code) Receptacle to Straight RJ45		M12 Female (X-Code) Receptacle to 90° RJ45	
Engineering No.	Standard Order No.	Engineering No.	Standard Order No.
ER2PADAPTER	1203410820	ER2PADAPTER90	1203410822



CAT6A Ethernet M12 Shielded Field Attachable (X-Code)

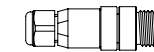

Poles	Cable Size	Wire Gauge	Wire Termination Style	Male Straight	
				Engineering No.	Standard Order No.
8	6.5 - 8.5mm	<AWG 18	IDC	E2AS06-52	1203410806

CAT6A Ethernet RJ45 Shielded Field Attachable



Poles	Cable Size	Wire Gauge	Wire Termination Style	Male Straight		Male 90°	
				Engineering No.	Standard Order No.	Engineering No.	Standard Order No.
8	5.5 - 9.0mm	AWG 24-22	IDC	E6AS06-5	1300478008	E6AS07-5	1300478009
8	5.5 - 9.0mm	AWG 26-24	IDC	E6AS06-6	1300478010	E6AS07-6	1300478011

Raw Cable

CAT6A EtherNet Shielded PUR Cable 20 - Teal	
Size	Standard Order No.
500FT Boxed	1203410103



Brad PROFINET Infrastructure Connectivity

molex



Plug & Play infrastructure to interconnect CAT5e PROFINET IP67 devices based on 4 Pole D-Code M12 standard connectors.

PROFINET Double-Ended Male to Male M12 Cordsets (D-Code)



PROFINET Shielded WSOR Cable 12 - Green		
Length	Engineering No.	Standard Order No.
0,5m	E11A06012M005	1201088303
1m	E11A06012M010	1201088304
2m	E11A06012M020	1201088305
3m	E11A06012M030	1201088306
5m	E11A06012M050	1201088308
10m	E11A06012M100	1201088311
15m	E11A06012M150	1201088313
20m	E11A06012M200	1201088315



PROFINET M12 Male (D-Code) to RJ45 Plug Cordsets



PROFINET Shielded WSOR Cable 12 - Green		
Length	Engineering No.	Standard Order No.
1m	E16A06012M010	1201080521
2m	E16A06012M020	1201080522
5m	E16A06012M050	1201088333
10m	E16A06012M100	1201080524



PROFINET RJ45 Plug to RJ45 Plug Cordsets



PROFINET Shielded WSOR Cable 12 - Green		
Length	Engineering No.	Standard Order No.
1m	E66A06012M010	1201088353
2m	E66A06012M020	1201088354
5m	E66A06012M050	1201088357
10m	E66A06012M100	1201088361



Brad PROFINET Infrastructure Connectivity

molex



Plug & Play infrastructure to interconnect CAT5e PROFINET IP67 devices based on 4 Pole D-Code M12 standard connectors.

PROFINET Female M12 (D-Code) Receptacle to RJ45 Plug Cordsets



PROFINET Shielded WSOR Cable 12 - Green		
Length	Engineering No.	Standard Order No.
1m	ERWPAU7012M010	1201080519
2m	ERWPAU7012M020	1201080520

PROFINET Female M12 Adaptors

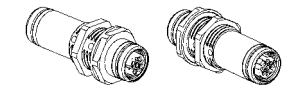
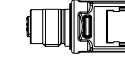

M12 Female Receptacle to Straight RJ45		M12 Female Receptacle to 90° RJ45		M12 Female to Female Bulkhead Receptacle	
Engineering No.	Standard Order No.	Engineering No.	Standard Order No.	Engineering No.	Standard Order No.
ER1PADAPTER	1300540031	ER1PADAPTER90	1300540010	1200848170	1200848170



PROFINET M12 Shielded Field Attachable (D-Code)

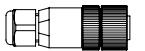
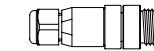

Poles	Cable Size	Wire Gauge	Wire Termination Style	Male Straight		Female Straight	
				Engineering No.	Standard Order No.	Engineering No.	Standard Order No.
4	6.0 - 8.0mm	<AWG 18	Screw	E1AS06-32	1300470035	E1AS00-32	1300470037
4	4.0 - 8.0mm	AWG 26-22	IDC	E1AS06-53	1300470039	E1AS00-53	1300470040

PROFINET RJ45 Shielded Field Attachable



Poles	Cable Size	Wire Gauge	Wire Termination Style	Male Straight		Male 90°	
				Engineering No.	Standard Order No.	Engineering No.	Standard Order No.
8	5.5 - 9.0mm	AWG 24-22	IDC	E6AS06-5	1300478008	E6AS07-5	1300478009
8	5.5 - 9.0mm	AWG 26-24	IDC	E6AS06-6	1300478010	E6AS07-6	1300478011

Raw Cable

PROFINET Shielded WSOR Cable 12 - Green	
Size	Standard Order No.
3x100m	1554215001
1x500m	1554215002
1x1000m	1554215003



Brad DeviceNet Infrastructure Connectivity

molex

Plug & Play infrastructure to DeviceNet IP67 devices based on Mini-Change 7/8" standard connectors.



DeviceNet

DeviceNet Mini-Change 7/8" 5 Pole Single-Ended Cordsets



Length	Single-End Female Straight - Thick PVC		Single-End Male Straight - Thick PVC	
	Engineering No.	Standard Order No.	Engineering No.	Standard Order No.
1m	DN10A-M010	1300240073	DN01A-M010	1300240028
2m	DN10A-M020	1300240077	DN01A-M020	1300240031

DeviceNet Mini-Change 7/8" 5 Pole Double-Ended Cordsets



Length	Straight to Straight - Thick PVC - Gray		Straight to Straight - Thin PVC - Gray		Straight to Straight - Thick TPE Flex		Straight to Straight - Thin TPE Flex		90° to 90° - Thin TPE Flex	
	Engineering No.	Standard Order No.	Engineering No.	Standard Order No.	Engineering No.	Standard Order No.	Engineering No.	Standard Order No.	Engineering No.	Standard Order No.
0,5m	DN11A-M005	1300250051	DND11A-M005	1300250285	DNF11A-M005	1300250406	-	-	-	-
1m	DN11A-M010	1300250054	DND11A-M010	1300250287	DNF11A-M010	1300250408	DNDF11A-M010	1300250502	DNDF99A-M010	1300250513
2m	DN11A-M020	1300250061	DND11A-M020	1300250290	DNF11A-M020	1300250411	DNDF11A-M020	1300250503	DNDF99A-M020	1300250332
3m	DN11A-M030	1300250067	DND11A-M030	1300250292	DNF11A-M030	1300250412	DNDF11A-M030	1300250504	DNDF99A-M030	1300250333
4m	DN11A-M040	1300250071	DND11A-M040	1300250294	DNF11A-M040	1300250413	DNDF11A-M040	1300250506	DNDF99A-M040	1300250334
5m	DN11A-M050	1300250073	DND11A-M050	1300250295	DNF11A-M050	1300250415	DNDF11A-M050	1300250508	DNDF99A-M050	1300250515
10m	DN11A-M100	1300250085	-	-	DNF11A-M100	1300250420	-	-	-	-
15m	DN11A-M150	1300250092	-	-	DNF11A-M150	1300250424	-	-	-	-
20m	DN11A-M200	1300250097	-	-	DNF11A-M200	1300250429	-	-	-	-
30m	DN11A-M300	1300250108	-	-	DNF11A-M300	1300250435	-	-	-	-

DeviceNet Micro-Change M12 to Mini-Change 7/8" 5 Pole Cordsets

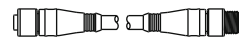

Length	Male Mini-Change 7/8" to Female M12 - Thin PVC	
	Engineering No.	Standard Order No.
1m	DND21A-M010	1300390157
2m	DND21A-M020	1300390159
3m	DND21A-M030	1300390164
5m	DND21A-M050	1300390166

DeviceNet Mini-Change 7/8" 5 Pole Receptacles



Length	Male Receptacle - Thick PVC		Male Receptacle - Thin PVC		Female Receptacle - Thick PVC		Female Receptacle - Thin PVC	
	Engineering No.	Standard Order No.	Engineering No.	Standard Order No.	Engineering No.	Standard Order No.	Engineering No.	Standard Order No.
0,5m	DN5100-M005	1300390297	DND5100-M005	1300310040	DN5000-M005	1300390283	DND5000-M005	1300390322
1m	DN5100-M010	1300390299	DND5100-M010	1300390327	DN5000-M010	1300390284	DND5000-M010	1300390323
2m	DN5100-M020	1300390300	DND5100-M020	1300390328	DN5000-M020	1300390285	DND5000-M020	1300310039

Brad DeviceNet Infrastructure Connectivity

molex

Plug & Play infrastructure to DeviceNet IP67 devices based on Mini-Change 7/8" standard connectors.



DeviceNet

DeviceNet Mini-Change 7/8" 5 Pole Field Attachable Connectors



Male		Female	
Engineering No.	Standard Order No.	Engineering No.	Standard Order No.
1A5006-34DN	1300340006	1A5000-34DN	1300340005

DeviceNet Mini-Change 7/8" 5 Pole Terminators



Indicator	Male		Female	
	Engineering No.	Standard Order No.	Engineering No.	Standard Order No.
No LED	DN100	1300390370	DN150	1300390376
LED	DN100L	1300390371	DN150L	1300390072

DeviceNet Mini-Change 7/8" 5 Pole Receptacle Pass-Thru, Male to Female

Pass-Thru	
Engineering No.	Standard Order No.
1R5030	1300130541

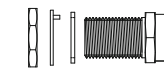

DeviceNet Mini-Change 7/8" 5 Pole Passive Tee

TEE	
Engineering No.	Standard Order No.
DN3020	1300350057

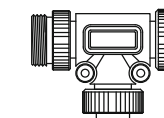

DeviceNet Mini-Change 7/8" 5 Pole Power Monitor Tee w/LED

Male to Female		Female to Male	
Engineering No.	Standard Order No.	Engineering No.	Standard Order No.
DN3020PM-1	1300350060	DN3020PM-3	1300350061

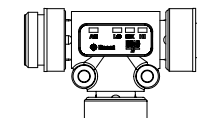

Brad DeviceNet Infrastructure Connectivity

molex

Plug & Play infrastructure to interconnect DeviceNet IP67 devices based on Micro-Change M12 and Nano-Change M8 standard connectors.



DeviceNet

DeviceNet Micro-Change M12 5 Pole Single-Ended Cordsets

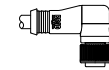
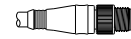

Length	Male Straight - Thin PVC - Gray		Female Straight - Thin PVC - Gray		Female 90° - Thin PVC - Gray	
	Engineering No.	Standard Order No.	Engineering No.	Standard Order No.	Engineering No.	Standard Order No.
1m	DND02A-M010	1300270012	DND20A-M010	1300270048	DND30A-M010	1300270075
2m	DND02A-M020	1300270014	DND20A-M020	1300270049	DND30A-M020	1300270076
3m	DND02A-M030	1300270015	DND20A-M030	1300270050	DND30A-M030	1300270077
5m	DND02A-M050	1300270017	DND20A-M050	1300270052	DND30A-M050	1300270079

DeviceNet Micro-Change M12 5 Pole Double-Ended Cordsets

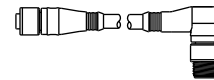
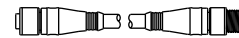

Length	Straight to Straight - Thin PVC - Gray		Female straight to Male 90° - Thin PVC - Gray	
	Engineering No.	Standard Order No.	Engineering No.	Standard Order No.
0,5m	DND22A-M005	1300280023	-	-
1m	DND22A-M010	1300280028	DND32A-M010	1300280085
2m	DND22A-M020	1300280033	DND32A-M020	1300280087
3m	DND22A-M030	1300280037	DND32A-M030	1300280089
5m	DND22A-M050	1300280042	DND32A-M050	1300280091

DeviceNet Micro-Change M12 to Nano-Change M8 5 Pole Double-Ended Cordsets

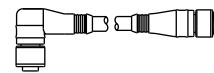
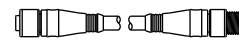

Length	Female M12 Straight to Male M8 Straight - Thin PVC - Gray		Female M12 90° to Male M8 Straight - Thin PVC - Gray	
	Engineering No.	Standard Order No.	Engineering No.	Standard Order No.
0.5m	845030D12M005	1300300023	845031D12M005	1300300032
1m	845030D12M010	1300300027	845031D12M010	1300300041
2m	845030D12M020	1300300029	845031D12M020	1300300058
3m	845030D12M030	1300300075	845031D12M030	1300300001

DeviceNet Micro-Change M12 5 Pole Receptacles

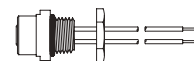
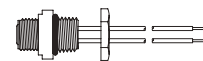

Length	Male Receptacle		Female Receptacle	
	Engineering No.	Standard Order No.	Engineering No.	Standard Order No.
12 inches	81612	1300310026	81611	1300310023

Brad DeviceNet Infrastructure Connectivity

molex

Plug & Play infrastructure to interconnect DeviceNet IP67 devices based on Micro-Change M12 and Nano-Change M8 standard connectors.



DeviceNet

DeviceNet Micro-Change M12 5 Pole Field Attachable Connectors



Male		Female	
Engineering No.	Standard Order No.	Engineering No.	Standard Order No.
8A5006-32DN	1300340008	8A5000-32DN	1300340007

DeviceNet Micro-Change M12 5 Pole Terminators



Indicator	Male		Female	
	Engineering No.	Standard Order No.	Engineering No.	Standard Order No.
No LED	DND100	1300390382	DND150	1300390385
LED	DND100L	1200390001	DND150L	1200390003

DeviceNet Micro-Change M12 5 Pole Receptacle Pass-Thru, Male to Female

Pass-Thru	
Engineering No.	Standard Order No.
8R5L30	1200700237

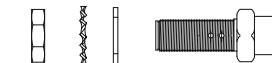

DeviceNet Micro-Change M12 5 Pole Passive Tee

TEE	
Engineering No.	Standard Order No.
MIC555	1300350090

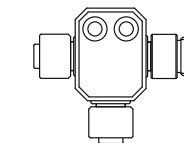



Sensor Solutions



Molex supports one of the largest portfolios of connectivity and wiring solutions in the industrial market and brings industry-leading expertise to deliver integrated solutions serving customers worldwide.

The collaboration with Contrinex, a Swiss-based manufacturer of inductive and photoelectric sensors for factory automation, expands Molex portfolio to address customers' requirements for smart manufacturing, thanks to the broad availability of IO link solutions within the product range.

At a glance

- Technology leading manufacturer of inductive and photoelectric sensors as well as safety and RFID systems
- World market leader for miniature sensors, sensors with long operating distances and devices for particularly demanding operating conditions (all-metal, high-pressure and high-temperature resistant sensors)
- Represented in over 60 countries worldwide, headquarters in Switzerland

Key Advantages



Inductive Sensors

Classic

- High quality ASIC (Application-Specific Integrated Circuits) sensors
- Excellent Accuracy
- Outstanding temperature compensation
- Vibration and shock resistant

Full Inox

- Robust one-piece stainless-steel housing
- Corrosion resistant
- IP68 and IP69K
- Pressure resistant



Photoelectric Sensors

Cubic Housing

- First class sensing ranges
- Outstanding background suppression characteristics
- Very high accuracy and reliability

Cylindrical Housing

- Excellent background suppression characteristics with pinpoint LED
- Easy flush mounting
- Sensing range up to 30m

Inductive Sensors Classics – 600 Series



Product range - Basic

Contrinex BASIC inductive sensors have a worldwide and well-deserved reputation for uncompromising accuracy and exceptional reliability. With best-in-class sensing distances between 1.5 mm and 40 mm, the Contrinex BASIC range offers fit-and-forget operation, delivering world-class performance and a highly attractive total cost of ownership.

Specification / Key Advantages

- Enclosure rating IP67
- Operating distance up to 2x (Sn 1.5 mm - 40 mm)
- Outstanding temperature stability -25... +70°C
- IO-Link ready (PNP NO output)
- High quality ASICs
- Output current ≤ 200 mA
- Supply voltage range 10...30 VDC

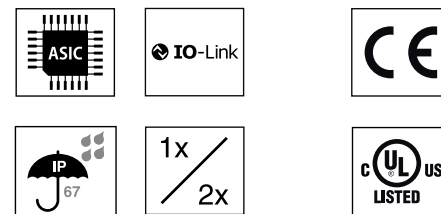

Housing sizes



Classic and Miniature								
Housing	Connection	Mounting	Operating distance [mm]	Housing length [mm]	Polarity	Output	Engineering No.	Standard Order No.
M8	Connector (M8)	Embeddable	2	45	PNP	Normally open (NO)	DW-AS-623-M8-001	1202530360
M8	Connector (M12)		2	45			DW-AS-623-M8	1202530364
M12	Connector (M12)		4	60			DW-AS-623-M12	1202530380
M18	Connector (M12)		8	63,5			DW-AS-623-M18-002	1202530396
Miniature Ø4mm	Connector (M8)		1,5	38			DW-AS-623-04	1202530519
Miniature M5	Connector (M8)		1,5	38			DW-AS-623-M5	1202530527

Extra Distance Basic								
Housing	Connection	Mounting	Operating distance [mm]	Housing length [mm]	Polarity	Output	Engineering No.	Standard Order No.
M8	Connector (M8)	Embeddable	3	60	PNP	Normally open (NO)	DW-AS-503-M8-001	1202530018
M8	Connector (M12)		3	66			DW-AS-503-M8	1202530022
M12	Connector (M12)		6	60			DW-AS-503-M12	1202530042
M18	Connector (M12)		12	63,5			DW-AS-503-M18-002	1202530058
M30	Connector (M12)		22	48,5			DW-AS-503-M30-120	1202530130

Extra Distance Analog								
Housing	Connection	Mounting	Operating distance [mm]	Housing length [mm]	Polarity	Output	Engineering No.	Standard Order No.
M8	Connector (M8)	Quasi-embeddable	≤ 4	60	n/a	0-10V	DW-AS-509-M8-390	1202530143
M12	Connector (M12)		≤ 6	45		0-5V	DW-AS-509-M12-120	1202530168
M18	Connector (M12)		≤ 10	48,5		0-10V	DW-AS-509-M18-320	1202530173
M30	Connector (M12)		≤ 20	48,5		0-10V	DW-AS-509-M30-320	1202530181

Inductive Sensors Full Inox – 700 Series



Product range - Extreme

Only the toughest sensors survive the most extreme environments, and Contrinex EXTREME inductive sensors from the Full Inox family are ideally equipped for the job. Thanks to one-piece stainless-steel (V2A/AISI 303) construction and a hermetically sealed cable entry, Extreme sensors are corrosion-resistant, impervious to oil, and pressure-resistant to 100 bar. Rugged, reliable and highly accurate, the EXTREME range is at home in the most challenging circumstances.



Specification / Key Advantages

- Mechanically and Chemically extremely robust
- Extremely rugged Full Inox types (one piece stainless-steel housing)
- Corrosion resistant
- IP 68 and IP 69K
- Pressure resistant up to 100 bar (1451 psi)
- IO-Link ready (PNP NO output)
- Long operating distance (Sn 3 mm - 40 mm)
- Outstanding temperature stability -25... +85°C
- High quality ASICs
- Output current ≤ 200 mA
- Supply voltage range 10 ... 30 VDC
- Factor 1 on Steel and aluminium

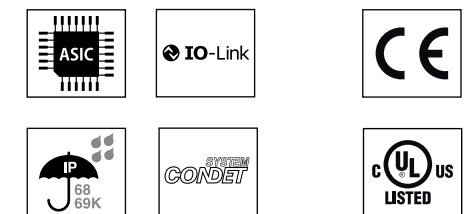

Housing sizes



Full Inox Extreme								
Housing	Connection	Mounting	Operating distance [mm]	Housing length [mm]	Polarity	Output	Engineering No.	Standard Order No.
M8	Connector (M8)	Embeddable	3	60	PNP	Normally open (NO)	DW-AS-703-M8-001	1202530535
M8	Connector (M12)	Embeddable	3	66			DW-AS-703-M8	1202530539
M12	Connector (M12)	Embeddable	6	60			DW-AS-703-M12	1202530559
M18	Connector (M12)	Embeddable	10	63,5			DW-AS-703-M18-002	1202530575
M30	Connector (M12)	Embeddable	20	63,5			DW-AS-703-M30-002	1202530591

Full Inox Weld-Immune Extremely robust and Resistant to welding spatter / No false switching caused by metal dust or chips								
Housing	Connection	Mounting	Operating distance [mm]	Housing length [mm]	Polarity	Output	Engineering No.	Standard Order No.
M8	Connector (M8)	Embeddable	3	60	PNP	Normally open (NO)	DW-AS-703-M8-673	1202530673
M12	Connector (M12)	Embeddable	6	60			DW-AS-703-M12-673	1202530674
M18	Connector (M12)	Embeddable	10	63,5			DW-AS-703-M18-673	1202530675

Full Inox Washdown ECOLAB Approved (Food and Beverage applications)								
Housing	Connection	Mounting	Operating distance [mm]	Housing length [mm]	Polarity	Output	Engineering No.	Standard Order No.
M12	Connector (M12)	Embeddable	6	60	PNP	Normally open (NO)	DW-LS-703-M12	1202530631
M18	Connector (M12)	Embeddable	10	63,5			DW-LS-703-M18-002	1202530647
M30	Connector (M12)	Embeddable	20	63,5			DW-LS-703-M30-002	1202530663

Photoelectric Sensors Cubic Housing



Product range - Miniature Cubic C12

The C12 Series (13.5 mm x 21.8 mm x 7.7 mm) with small visible light spot thanks to red pinpoint LED offers long sensing ranges up to 2000 mm in a through-beam type and 3000 mm in a polarized reflex type. Two background suppression types are available with fixed sensing ranges up to 15 mm or 30 mm. A third type with 3-turn potentiometer (13.5 mm x 27.5 mm x 7.7 mm) reliably detects objects up to 120 mm.



Specification / Key Advantages

- Long sensing ranges
- Background suppression up to 120 mm
- Excellent background suppression characteristics
- 45° angle cable outlet for easy installation
- Plastic housing, 13 mm x 21 mm / 27 mm x 7 mm
- Red pinpoint LED, small visible light spot

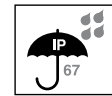

Miniature C12 – Housing Sizes

13.5x18.9 mm 13.5x27.5 mm



Classic and Miniature								
Operating principle	Connection	Adjustment	Operating distance [mm]	Housing dimensions [mm]	Polarity	Output	Engineering No.	Standard Order No.
Through-beam (Receiver)	pigtail PVC 0.2m (M8)	No	2000	13.5x18.9	PNP	dark-ON	LLR-C12PA-NMV-304	1202540002
Through-beam (emitter)		No	-	13.5x18.9	-	-	LLR-C12PA-NMV-300	1202540005
Reflex		No	3000	13.5x18.9	PNP	dark-ON	LRR-C12PA-NMV-304	1202540009
Background suppression		Potentiometer	120	13.5x27.5	PNP	light-ON	LHR-C12PA-PLV-303	1202540020

Photoelectric Sensors Cubic Housing



Product range - Cubic C23

Whatever the application, C23 series sensors meet its highest demands. Their miniature size (20 x 30 x 10 mm), first-class sensing ranges and practical accessories are ideal for limited spaces. Housings have an IP67 enclosure rating and are Ecolab-approved for use in hygienic areas. Versions with background suppression and pinpoint LED ensure high reliability and extended detection ranges. All PNP types include IO-Link communication, a key enabling technology for Industry 4.0 and the Industrial Internet of Things.



Specification / Key Advantages

- First-class sensing ranges
- Small plastic housing, 20 mm x 30 mm x 10 mm
- Excellent background suppression characteristics with pinpoint LED
- IO-Link interface available on PNP types
- Mutual interference immunity
- Versions available with stability alarm as second output
- Enclosure rating IP67, Ecolab approved
- Versatile mounting brackets for ease of installation
- Sensing range up to 5000 mm

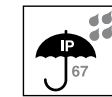
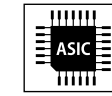

Standard C23 – Housing Size

20mm x 30mm



Classic and Miniature								
Operating principle	Connection	Adjustment	Operating distance [mm]	Housing dimensions [mm]	Polarity	Output	Engineering No.	Standard Order No.
Through-beam (Receiver)	connector (M8)	No	30.000	20x30	PNP	Changeover / IO Link	LLR-C23PA-NMS-603	1202540030
Through-beam (emitter)	connector (M8)	No	-	20x30	-	-	LLR-C23PA-NMS-400	1202540033
Reflex	connector (M8)	No	8.000	20x30	PNP	Changeover / IO Link	LRR-C23PA-NMS-603	1202540036
Background suppression	connector (M12)	Potentiometer	300	20x30	PNP	Changeover / IO Link	LHR-C23PA-PMS-603	1202540044
Transparent reflex	connector (M12)	Teach	1.200	20x30	PNP	Changeover / IO Link	TRU-C23PA-TMS-603	1202540056

Photoelectric Sensors Cylindrical Housing



Product range - Standard M18 Plastic

Small, flexible and easy to integrate into different machine environments: all these requirements are met by the new photoelectric sensors of Contrinex's short M18 series. This includes reflex, through-beam and diffuse sensors with or without background suppression. The small plastic housings with M18 diameter are only 33 mm long in the cable version or 37 mm in the connector type. Sensors are embeddable and easy to install even in confined spaces. Background suppression types feature a pinpoint LED and specially adapted optics, ensuring excellent characteristics. All PNP versions include IO-Link communication, a key enabling technology for Industry 4.0 and the Industrial Internet of Things.



Specification / Key Advantages

Sensing range up to 30m
First-class sensing ranges
Short housing: M18 x 33 mm (cable version), M18 x 37 mm (connector version)
Excellent background suppression characteristics with pinpoint LED

Mutual interference immunity on all PNP sensors
Easy flush mounting
Easy-to-mount special accessories for right-angle emission
High quality ASICs
IO-Link

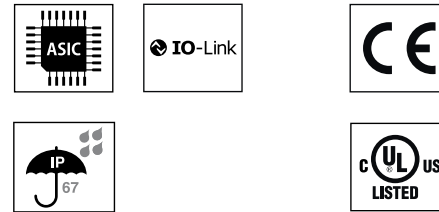

Standard M18 Plastic – Housing sizes

13.5x18.9 mm



Standard M18 Plastic

Operating principle	Connection	Adjustment	Operating distance [mm]	Housing dimensions [mm]	Polarity	Output	Engineering No.	Standard Order No.
Diffuse	connector (M12)	No	1200	37	PNP	light-ON / IO-Link	LTR-M18PA-NMS-403	1202540113
Diffuse		Potentiometer	1200	37	PNP	Changeover / IO Link	LTR-M18PA-PMS-603	1202540116
Through-beam (Receiver)		No	30000	37	PNP	Changeover / IO Link	LLR-M18PA-NMS-603	1202540120
Through-beam (emitter)		No	-	37	-	-	LLR-M18PA-NMS-400	1202540123
Reflex		No	7000	37	PNP	Changeover / IO Link	LRR-M18PA-NMS-603	1202540126
Background suppression		Potentiometer	10...250	37	PNP	Changeover / IO Link	LHR-M18PA-PMS-603	1202540134

Housing sizes

Standard Reflector UV Reflector



Classic and Miniature

Housing dimensions [mm]	Type	Material	Engineering No.	Standard Order No.
Ø46.5	Standard	PMMA housing with adhesive	LXR-0000-046	1202550002
Ø82.0	Standard UV	Plastic housing with adhesive	LXU-0000-084	1202550011

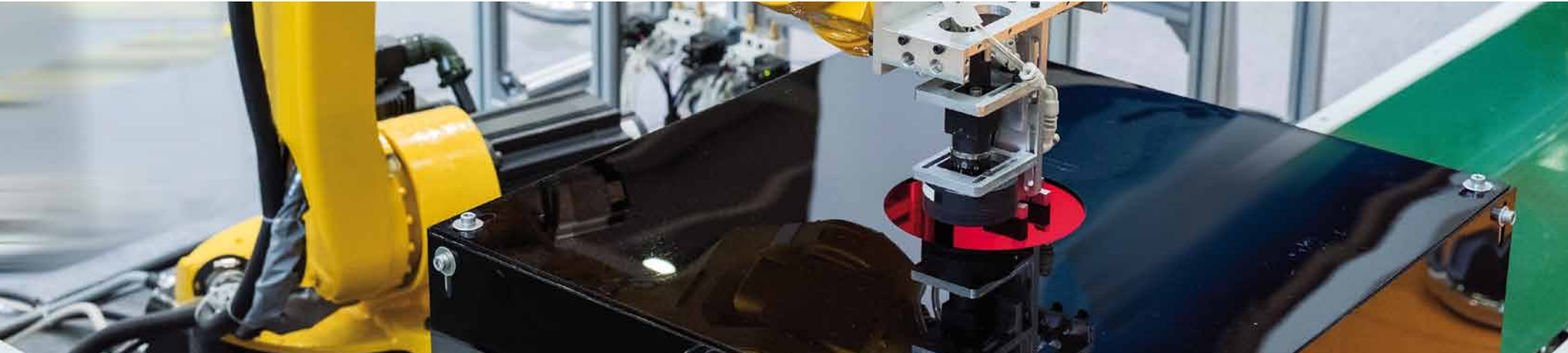

Sensors and Actuators Connectivity

Micro-Change M12 Sensor/Actuator Interconnection

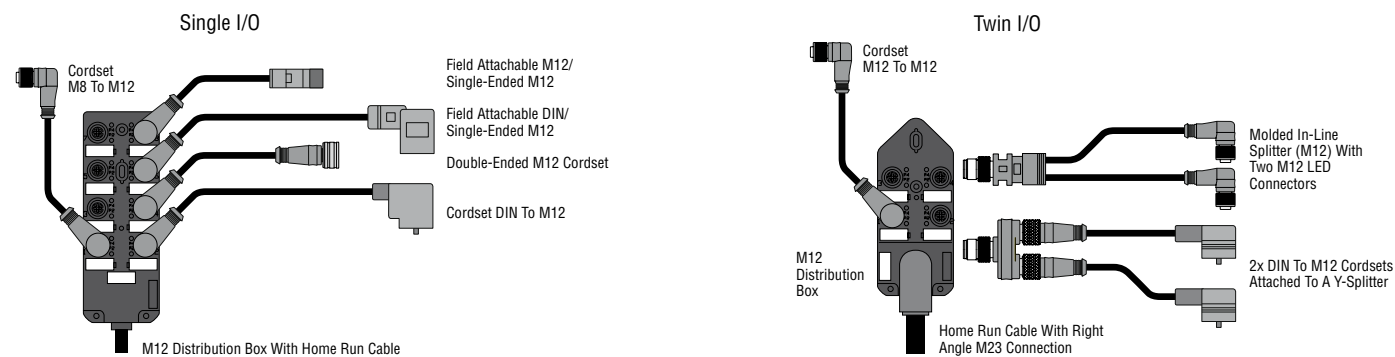

Nano-Change M8 Sensor/Actuator Interconnection

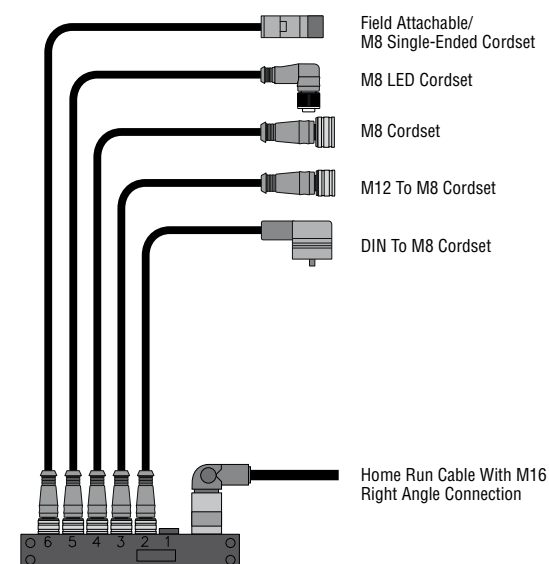

Further Industrial power connectors from Molex

Brad Multi-Port Interconnection Systems (MPIS)
Solution to reduce Installation time and costs through:

- IP67 protection can be installed directly on the machine, close to the automation devices keeping single wiring distances low.
- Concentrate sensor and actuator signals and distribute the Power supply reducing homerun cable dimensions.
- Signal diagnostic information to quickly detect machine status and failures on devices.
- Home run cable termination via an M16/M23 connector, via field terminated screw terminal for installation flexibility or for cost savings directly mounted on the module.

Single and Dual signal ports
Brad MPIS and Active HarshIO I/O Ports can manage up to 2 signals per ports (Twin I/O).

Signals are concentrated on Twin I/O ports:

- By using Splitter cordsets
- By using solid body Y or Tee Splitters as shown in above draft.

Primary signal (from device A) will be on Pin 4
Secondary signal (from device B) will be on Pin 2
As displayed below.

MPIS Applications

MPIS solutions are ideal in case of small or mid size machines. Larger Machines or higher IO counts may prefer the active networked HarshIO modules.



Brad MPIS Sensor/Actuator Distribution Boxes

molex

IP67 rated passive IO module for harsh environments are designed to concentrate the sensor/actuator signals into one unique home run cable for a better mechanical infrastructure wiring on the machine.

Specifications

IP67 Molded PBT Housing, color Black
Single or Dual Input/Output signal per port
Indicating LED for Power and sensor trigger

PNP Version (available also in NPN version)
Electrical: 10-30V DC max. & 12.0A max. (4.0A max. per port) Approvals: UL, CSA, IP67



Brad M12 Distribution Boxes with Home Run Cable



IO Type	Length	4 Ports		8 Ports	
		Engineering No.	Standard Order No.	Engineering No.	Standard Order No.
Single IO	5m	BTB400P-FBW-05	1202480004	BTB800P-FBW-05	1202480022
	10m	BTB400P-FBW-10	1202480005	BTB800P-FBW-10	1202480023
Dual IO	5m	BTB405P-FBW-05	1202480031	BTB805P-FBW-05	1202480049
	10m	BTB405P-FBW-10	1202480032	BTB805P-FBW-10	1202480050

Brad M12 Distribution Boxes with M23 Connector and Home Run Cable



IO Type	4 Ports		8 Ports	
	Engineering No.	Standard Order No.	Engineering No.	Standard Order No.
Single IO	BTB401P-FBC	1202480056	BTB801P-FBC	1202480060
Dual IO	BTB403P-FBC	1202480062	BTB803P-FBC	1202480066

Length	Single IO Home Run Cable (12p/11 wires)		Dual IO Home Run Cable (19p/19 wires)	
	Engineering No.	Standard Order No.	Engineering No.	Standard Order No.
10m	K02101B80M100*	1200948150	K03001B80M100*	1200948163

Brad M12 Distribution Boxes with Mini-Change Connector and Home Run Cable

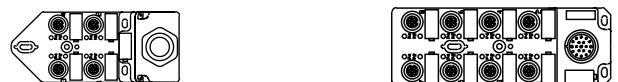

IO Type	4 Ports		8 Ports	
	Engineering No.	Standard Order No.	Engineering No.	Standard Order No.
Single IO	BTB401P-FBB	1202480068	BTB801P-FBB	1202480074
Dual IO	BTB403P-FBB	1202480077	BTB803P-FBB	1202480083

Length	Single IO Home Run Cable (12p/11 wires)		Dual IO Home Run Cable (19p/19 wires)	
	Engineering No.	Standard Order No.	Engineering No.	Standard Order No.
10m	302101A04M100	1300080282	303001P80M100	1300080316

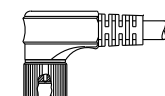
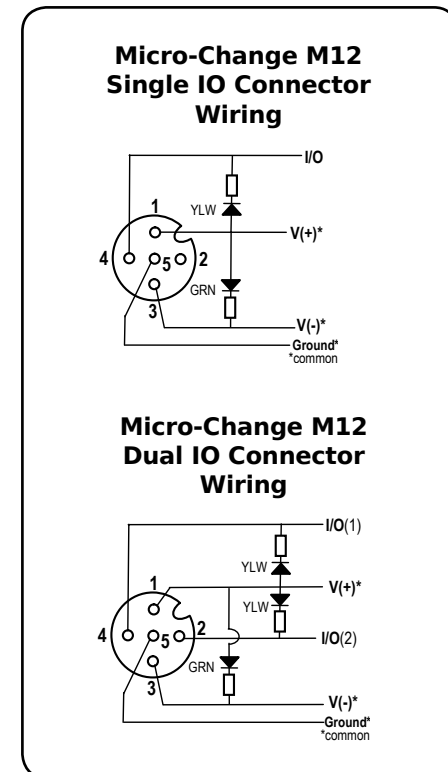

Brad MPIS Sensor/Actuator Distribution Boxes

molex

Brad M8 Distribution Boxes with Side Mount PUR Home Run Cable



IO Type	Length	4 Ports		6 Ports	
		Engineering No.	Standard Order No.	Engineering No.	Standard Order No.
Single IO	5m	BEB401P-FBW-05	1202470001	BEB601P-FBW-05	1202470040
	10m	BEB401P-FBW-10	1202470002	BEB601P-FBW-10	1202470041

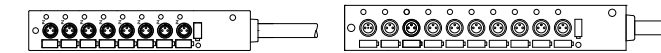

IO Type	Length	8 Ports		10 Ports	
		Engineering No.	Standard Order No.	Engineering No.	Standard Order No.
Single IO	5m	BEB801P-FBW-05	1202470012	BEBA01P-FBW-05	1202470006
	10m	BEB801P-FBW-10	1202470013	BEBA01P-FBW-10	1202470007

Brad M8 Distribution Boxes with M16 Connector and Home Run Cable

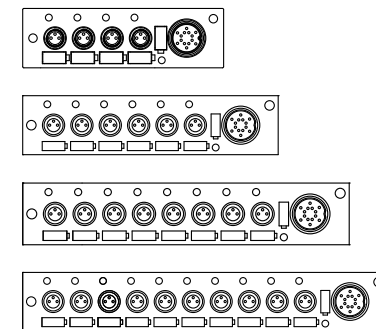

Ports	Single IO Distribution Box with M16 connector	
	Engineering No.	Standard Order No.
4	BNB401P-FBC	1202470059
6	BNB601P-FBC	1202470061
8	BNB801P-FBC	1202470063
10	BNBA01P-FBC	1202470065

Block	M16 Single IO Home Run Cable 10 Meter	
	Engineering No.	Standard Order No.
4 Ports	L04301B78M100*	1300238011
6 Ports	L04201B78M100*	1300238017
8 Ports	L04101B78M100*	1300238023
10 Ports	L04A01B78M100*	1300238029

*Home run cable also available in 5m and 15m length.



Nano-Change M8 Single IO Connector Wiring

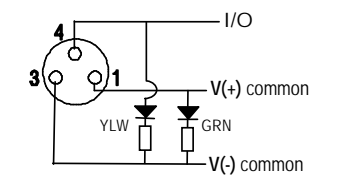

B80 WSOR raw cable ordering information



Wires	Size	Standard Order No.
3xAWG19 + 16xAWG22	1x100m	1552209019
	1x500m	1552209020
	1x1000m	1552209021

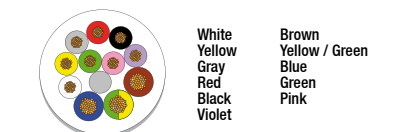

Wires	Size	Standard Order No.
3xAWG19 + 8xAWG22	1x200m	1552209013
	1x500m	1552209014
	1x1000m	1552209015

Note: Further technical information, datasheet or drawing can be downloaded from the Molex website using the ordering part number.

Brad Micro-Change M12 Sensor/Actuator Connectivity

molex

Brad Micro-Change M12 connectivity is a ready-to-use solution based on the A-Code M12 standard with IP67/68 rating to wire a wide range of sensors and actuators from proximity switches to rotary encoders in harsh environments.



Brad Micro-Change M12 Single-Ended Cordsets



A09 PVC Cable									
Poles	Length	Female Straight		Female 90°		Male Straight		Male 90°	
		Engineering No.	Standard Order No.	Engineering No.	Standard Order No.	Engineering No.	Standard Order No.	Engineering No.	Standard Order No.
3	2m	803000A09M020	1200650129	803001A09M020	1200651444	803006A09M020	1200650200	803007A09M020	1200651497
	5m	803000A09M050	1200650139	803001A09M050	1200651451	803006A09M050	1200650203	803007A09M050	1200651499
	10m	803000A09M100	1200650148	803001A09M100	1200651457	803006A09M100	1200650207	803007A09M100	1200659208
4	2m	804000A09M020	1200650255	804001A09M020	1200651551	804006A09M020	1200650414	804007A09M020	1200651662
	5m	804000A09M050	1200650265	804001A09M050	1200651558	804006A09M050	1200650419	804007A09M050	1200651666
	10m	804000A09M100	1200650277	804001A09M100	1200651567	804006A09M100	1200650425	804007A09M100	1200651669
5	2m	805000A09M020	1200650471	805001A09M020	1200651697	805006A09M020	1200650523	805007A09M020	1200651724
	5m	805000A09M050	1200650479	805001A09M050	1200651701	805006A09M050	1200650528	805007A09M050	1200651727
	10m	805000A09M100	1200650487	805001A09M100	1200651706	805006A09M100	1200650533	805007A09M100	1200652123

Brad Micro-Change M12 Sensor/Actuator Connectivity

molex

Plug & Play 5 Pole power distribution infrastructure to interconnect IP67 devices based on the A-Code M12 standard connectors.



Brad Micro-Change M12 Single-Ended Cordsets



K05/K03 TPE Cable									
Poles	Length	Female Straight		Female 90°		Male Straight		Male 90°	
		Engineering No.	Standard Order No.	Engineering No.	Standard Order No.	Engineering No.	Standard Order No.	Engineering No.	Standard Order No.
3	2m	803000K05M020	1200651108	803001K05M020	1200651489	803006K05M020	1200651114	803007K05M020	1200651501
	5m	803000K05M050	1200651110	803001K05M050	1200651491	803006K05M050	1200651117	803007K05M050	1200651503
	10m	803000K05M100	1200651112	803001K05M100	1200651493	803006K05M100	1200651119	803007K05M100	1200651505
4	2m	804000K05M020	1200651121	804001K05M020	1200651639	804006K05M020	1200651129	804007K05M020	1200651691
	5m	804000K05M050	1200651124	804001K05M050	1200651642	804006K05M050	1200651131	804007K05M050	1200651693
	10m	804000K05M100	1200651126	804001K05M100	1200651644	804006K05M100	1200651133	804007K05M100	1200651695
5	2m	805000K03M020	1200651367	805001K03M020	1200651720	805006K03M020	1200651374	805007K03M020	1200652159
	5m	805000K03M050	1200651370	805001K03M050	1200651722	805006K03M050	1200652151	805007K03M050	1200652161
	10m	805000K03M100	1200651373	805001K03M100	1200652155	805006K03M100	1200652153	805007K03M100	1200652163

Build-A-Part Number Configuration Code



K05 Raw cable ordering information

Poles	Size	Standard Order No.
3 Poles	3x200m	1552408001
	1x800m	1552408002
	1x1500m	1552408003
4 Poles	3x200m	1552408004
	1x800m	1552408005
	1x1500m	1552408006
5 Poles	3x100m	1552408007
	1x500m	1552408008
	1x1000m	1552408009

K03 Raw cable ordering information

Poles	Size	Standard Order No.
3 Poles	3x100m	1552408010
	1x500m	1552408011
	1x1000m	1552408012
4 Poles	3x100m	1552408013
	1x500m	1552408014
	1x1000m	1552408015
5 Poles	3x100m	1552408016
	1x500m	1552408017
	1x1000m	1552408018

B30 WSOR Cable									
Poles	Length	Female Straight		Female 90°		Male Straight		Male 90°	
		Engineering No.	Standard Order No.	Engineering No.	Standard Order No.	Engineering No.	Standard Order No.	Engineering No.	Standard Order No.
3	2m	803000B30M020	1200652248	803001B30M020	1200652260	803006B30M020	1200652272	803007B30M020	1200652284
	5m	803000B30M050	1200652249	803001B30M050	1200652261	803006B30M050	1200652273	803007B30M050	1200652285
	10m	803000B30M100	1200652250	803001B30M100	1200652262	803006B30M100	1200652274	803007B30M100	1200652286
4	2m	804000B30M020	1200652252	804001B30M020	1200652264	804006B30M020	1200652276	804007B30M020	1200652288
	5m	804000B30M050	1200652253	804001B30M050	1200652265	804006B30M050	1200652277	804007B30M050	1200652289
	10m	804000B30M100	1200652254	804001B30M100	1200652266	804006B30M100	1200652278	804007B30M100	1200652290
5	2m	805000B30M020	1200659519	805001B30M020	1200659523	805006B30M020	1200659527	805007B30M020	1200659531
	5m	805000B30M050	1200659520	805001B30M050	1200659524	805006B30M050	1200659528	805007B30M050	1200659532
	10m	805000B30M100	1200659521	805001B30M100	1200659525	805006B30M100	1200659529	805007B30M100	1200659533
8	2m	808000B41M020	1200659458	808001B41M020	1200652311	808006B41M020	1200659453	808007B41M020	1200652315
	5m	808000B41M050	1200652308	808001B41M050	1200652312	808006B41M050	1200652304	808007B41M050	1200652316
	10m	808000B41M100	1200659463	808001B41M100	1200652313	808006B41M100	1200652305	808007B41M100	1200652317

Brad Micro-Change M12 Sensor/Actuator Connectivity

molex

Plug & Play 5 Pole power distribution infrastructure to interconnect IP67 devices based on the A-Code M12 standard connectors.



Brad Micro-Change M12 Double-Ended Cordsets



A09 PVC Cable					
Poles	Length	Female to Male Straight		Female 90° to Male Straight	
		Engineering No.	Standard Order No.	Engineering No.	Standard Order No.
4	.6m	884030A09M006	1200660262	884031A09M006	1200661261
	1m	884030A09M010	1200660266	884031A09M010	1200661262
	2m	884030A09M020	1200660271	884031A09M020	1200661265
	3m	884030A09M030	1200660277	884031A09M030	1200661268
	5m	884030A09M050	1200660284	884031A09M050	1200661273
5	10m	884030A09M100	1200660297	884031A09M100	1200661280
	.6m	885030A09M006	1200660426	885031A09M006	1200668730
	1m	885030A09M010	1200660427	885031A09M010	1200661389
	2m	885030A09M020	1200660429	885031A09M020	1200661391
	3m	885030A09M030	1200660431	885031A09M030	1200661392
	5m	885030A09M050	1200660434	885031A09M050	1200661394
	10m	885030A09M100	1200660440	885031A09M100	1200661396

A09 PVC M12 Cable Specification

For use in packaging machines and production lines, in static or less demanding environments.
 Conductors: 3 x 22, 4 x 22 or 5 x 22 AWG
 (Black, Brown, Blue, White, Grey)
 Jacket Material: Yellow PVC
 Voltage Rating: 300V
 Operating Temperature: -20 to +105°C
 Diameter 3 pole 4,8^{+/-0.3} mm
 Diameter 4 pole 5,1^{+/-0.3} mm
 Diameter 5 pole 5,5^{+/-0.3} mm
 Approvals: UL Style 2661, CSA

A09 Raw cable ordering information

Poles	Size	Standard Order No.
3 Poles	3x200m	1552108001
	1x800m	1552108002
	1x1500m	1552108003
4 Poles	3x200m	1552108004
	1x800m	1552108005
	1x1500m	1552108006
5 Poles	3x200m	1552108007
	1x800m	1552108008
	1x1500m	1552108009

Brad Micro-Change M12 Sensor/Actuator Connectivity

molex



Brad Micro-Change M12 Double-Ended Cordsets



B30 WSOR Cable					
Poles	Length	Female To Male Straight		Female 90° To Male Straight	
		Engineering No.	Standard Order No.	Engineering No.	Standard Order No.
3	2m	883030B30M020	1200668891	883031B30M020	1200668879
	5m	883030B30M050	1200668893	883031B30M050	1200668881
	10m	883030B30M100	1200668894	883031B30M100	1200668882
4	2m	884030B30M020	1200668819	884031B30M020	1200668831
	5m	884030B30M050	1200668821	884031B30M050	1200668833
	10m	884030B30M100	1200668822	884031B30M100	1200668834
5	2m	885030B30M020	1200668993	885031B30M020	1200668999
	5m	885030B30M050	1200668995	885031B30M050	1200669001
	10m	885030B30M100	1200668996	885031B30M100	1200669002
8	2m	888030B41M020	1200668897	888031B41M020	1200668885
	5m	888030B41M050	1200668899	888031B41M050	1200668887
	10m	888030B41M100	1200668900	888031B41M100	1200668888

B30 WSOR Cable Specification*

Conductors: 3x0,34 mm², 4x0,34 mm² or 5x0,34 mm² **
 (Brown, White, Blue, Black, Grey)
 Jacket material: Black WSOR, flame retardant, oil, UV & Weld Slag resistant, silicone & FCKW free
 Diameter 3 Pole: 4,8^{+/-0.2} mm
 Diameter 4 Pole: 5,1^{+/-0.2} mm
 Diameter 5 Pole: 5,5^{+/-0.2} mm
 Voltage Rating: 600V
 Static Operating Temp: -40 to +90°C
 Dynamic Operating Temp: -25 to +80°C
 Drag Chain (20 Mio cycles at 15xO.D.) & torsion suitable
 Approvals: UL AWM Style 21215 / CSA

* Detailed cable specification attached to bulk cable drawings
 ** 8 pole cable specification: see B41 description in M8 section



B30 Raw cable ordering information

Poles	Size	Standard Order No.
3 Poles	3x200m	1552200052
	1x800m	1552200053
	1x1500m	1552200054
4 Poles	3x200m	1552200064
	1x800m	1552200065
	1x1500m	1552200066
5 Poles	3x200m	1552200076
	1x800m	1552200077
	1x1500m	1552200078

Brad Micro-Change M12 Sensor/Actuator Connectivity

molex



Brad Micro-Change M12 Double-Ended Cordsets

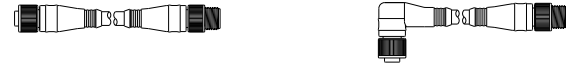

K05/K03 TPE Cable					
Poles	Length	Female to Male Straight		Female 90° to Male Straight	
		Engineering No.	Standard Order No.	Engineering No.	Standard Order No.
4	.6m	884030K05M006	1200660686	884031K05M006	1200660375
	1m	884030K05M010	1200660687	884031K05M010	1200660376
	2m	884030K05M020	1200660689	884031K05M020	1200660378
	3m	884030K05M030	1200660690	884031K05M030	1200660379
	5m	884030K05M050	1200660692	884031K05M050	1200660381
	10m	884030K05M100	1200660695	884031K05M100	1200660546
5	.6m	885030K03M006	1200661033	885031K03M006	1200668731
	1m	885030K03M010	1200661034	885031K03M010	1200661046
	2m	885030K03M020	1200661035	885031K03M020	1200661047
	3m	885030K03M030	1200661036	885031K03M030	1200661048
	5m	885030K03M050	1200661038	885031K03M050	1200661050
	10m	885030K03M100	1200661043	885031K03M100	1200668732

K05/K03 TPE M12 Cable Specification

For use in machine tools, metal cutting production with harsh fluid, mechanical or continuous flex requirements.

Conductors: 3 x 22, 4 x 22 or 5 x 18 AWG (Black, Brown, Blue, White, Grey)

Jacket Material: Yellow TPE

Voltage Rating: 300V

Operating Temperature: -40 to +105°C

Bending Cycles: 20 Mio cycles at 15xO.D.

Diameter 3 pole 5,0 ^{+/- 0.2} mm

Diameter 4 pole 5,2 ^{+/- 0.2} mm

Diameter 5 pole 7,0 ^{+/- 0.2} mm

Approvals: UL PLTC, CSA FT4

K03 Raw cable ordering information

Poles	Size	Standard Order No.
3 Poles	3x100m	1552408010
	1x500m	1552408011
	1x1000m	1552408012
4 Poles	3x100m	1552408013
	1x500m	1552408014
	1x1000m	1552408015
5 Poles	3x100m	1552408016
	1x500m	1552408017
	1x1000m	1552408018

Brad Micro-Change M12 Sensor/Actuator Connectivity

molex



Brad Micro-Change M12 Front Mount Receptacles



12" PVC Wire Leads					
Poles	Mount Thread	Male		Female	
		Engineering No.	Standard Order No.	Engineering No.	Standard Order No.
3	1/4"-18NPT	8R3A06A18A120	TBD	8R3A00A18A120	1200700056
	1/2"-14NPT	8R3006A18A120	1200700093	8R3000A18A120	1200705200
4	1/4"-18NPT	8R4A06A18A120	1200700385	8R4A00A18A120	1200700114
	1/2"-14NPT	8R4006A18A120	1200700184	8R4000A18A120	1200700173
5	1/4"-18NPT	8R5A06A18A120	1200708180	8R5A00A18A120	1200700201
	1/2"-14NPT	8R5006A18A120	1200700252	8R5000A18A120	1200705206

Brad Micro-Change M12 Sensor/Actuator Connectivity

molex

Brad M12 Cable Splitters

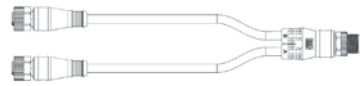

A09 PVC cable			
2x Female to Male Straight			
Poles	Length	Engineering No.	Standard Order No.
4	0.3m	884A30A09M003	1200680175
	0.6m	884A30A09M006	1200680176

B30 WSOR Cable			
2x Female to Male Straight			
Poles	Length	Engineering No.	Standard Order No.
4	0.3m	884A30B30M003	1200688282
	0.6m	884A30B30M006	1200688193

K05 TPE cable			
2x Female to Male Straight			
Poles	Length	Engineering No.	Standard Order No.
4	0.3m	884A30K05M003	1200680195
	0.6m	884A30K05M006	1200680196

Brad Micro-Change M12 Y-Splitters & Adapters



Adapter Connector		
1xM12 Male to 1xM8 Female		
Poles	Engineering No.	Standard Order No.
3	483030	1200330002
4	484030	1200330001

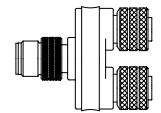
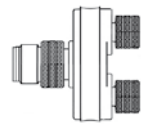

Y-Splitter M12 to M8		
1x M12 Male to 2x M8 Female		
Poles	Engineering No.	Standard Order No.
4	080804EMF00000	1200890031

Y-Splitter M12 to M12		
1x M12 Male to 2x M12 Female		
Poles	Engineering No.	Standard Order No.
4	81594R	1200680170
5	081205EMF00000	1200680139

Brad Nano-Change M8 Y-Splitters & Adapters

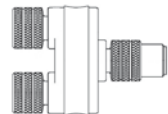
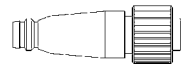

Adapter Connector		
1x M8 Male to 1x M12 Female		
Poles	Engineering No.	Standard Order No.
3	853030	1200170004
4	854030	1200170003

Y-Splitter		
1x M8 Male to 2x M8 Female		
Poles	Engineering No.	Standard Order No.
4	080804LMF00000	1200890033

Note: M8 male connector thread is fixed.



M12 Cable Splitter Wiring

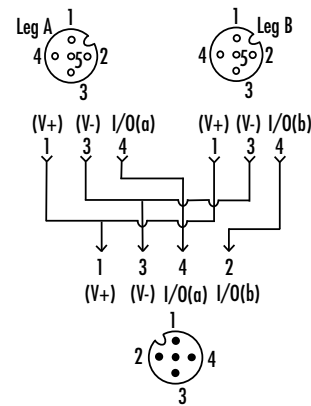

Y-Splitter Wiring Schematic

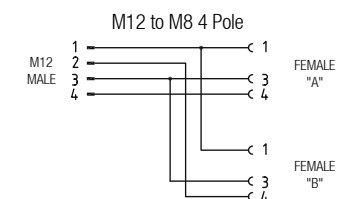
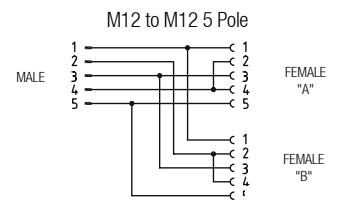
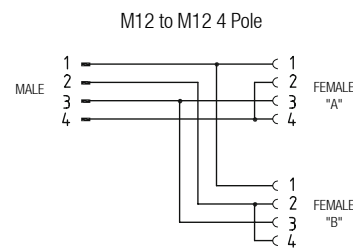

Brad Micro-Change M12 Sensor/Actuator Connectivity

molex

Brad Micro-Change M12 Field Attachable for Sensors and Actuators

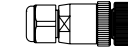
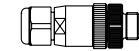

Poles	Cable Size	Wire Gage	Male Straight		Female Straight	
			Engineering No.	Standard Order No.	Engineering No.	Standard Order No.
Unshielded & Screw termination						
4	3.3-6.6	<AWG 18	8A4006-31	1200710038	8A4000-31	1200710035
	4.1-8.1	<AWG 18	8A4006-32	1200710039	8A4000-32	1200710036
5	3.3-6.6	<AWG 18	8A5006-31	1200710045	8A5000-31	1200710041
	4.1-8.1	<AWG 18	8A5006-32	1200710047	8A5000-32	1200710043
8	6.0-8.0	<AWG 20	8A8006-32	1200710030	8A8000-32	1200710031
Unshielded & IDC termination						
4	3.5-6.0	AWG26-22	8A4006-51	1200710086	8A4000-51	1200710087
	4.0-8.0	AWG22-18	8A4006-52	1200710088	8A4000-52	1200710089
Shielded & Screw termination						
4	6.0-8.0	<AWG 18	8A4S06-32	1200710032	8A4S00-32	1200710033
5	6.0-8.0	<AWG 18	8A5S06-32	1200710034	8A5S00-32	1200710081
8	6.0-8.0	<AWG 20	8A8S06-32	1200710082	8A8S00-32	1200710083

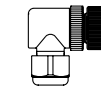
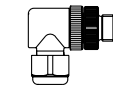

Poles	Cable Size	Wire Gage	Male 90°		Female 90°	
			Engineering No.	Standard Order No.	Engineering No.	Standard Order No.
Unshielded & Screw termination						
4	3.3-6.6	<AWG 18	8A4007-31	1200710040	8A4001-31	1200710037
	4.1-8.1	<AWG 18	8A4007-32	1200715011	8A4001-32	1200715010
5	3.3-6.6	<AWG 18	8A5007-31	1200710049	8A5001-31	1200710044
	4.1-8.1	<AWG 18	8A5007-32	1200710071	8A5001-32	1200710070

Brad Micro-Change M12 Bulkhead



M12 Bulkhead	
Poles	Standard Order No.
5	1200848168
8	1200848169

Micro-Change® M12 Connector Pinout

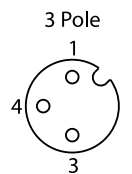

1 - Brown 4 - Black
3 - Blue

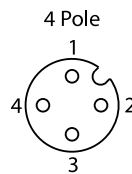

1 - Brown 3 - Blue
2 - White 4 - Black

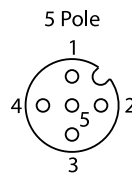

1 - Brown 4 - Black
2 - White 5 - Grey
3 - Blue

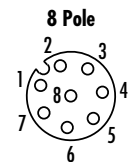

1 - White 5 - Grey
2 - Brown 6 - Pink
3 - Green 7 - Blue
4 - Yellow 8 - Red

Brad Micro-Change M12 Sensor/Actuator Connectivity

molex

Flamar Unshielded Signal & Control Cable Reels

Cross Section		Cable Code - Material	No. of Circuits	Cable Diameter in mm	Packaging		
mm ²	AWG				3x200m	1x800m	1x1500m
0.34	22	WSOR	3	4.8	1552200052	1552200053	1552200054
			4	5.1	1552200064	1552200065	1552200066
			5	5.5	1552200076	1552200077	1552200078
		PVC	3	4.8	1552100052	1552100053	1552100054
			4	5.1	1552100064	1552100065	1552100066
			5	5.5	1552100076	1552100077	1552100078
		PUR	3	4.8	1552300052	1552300053	1552300054
			4	5.1	1552300064	1552300065	1552300066
			5	5.5	1552300076	1552300077	1552300078

Cross Section		Cable Code - Material	No. of Circuits	Cable Diameter in mm	Packaging		
mm ²	AWG				3x100m	1x500m	1x1000m
0.25	24	WSOR	8	6.4	1552200034	1552200035	1552200036
		PVC			1552100034	1552100035	1552100036
		PUR			1552300034	1552300035	1552300036

Flamar Shielded Signal & Control Cable Reels

Cross Section		Cable Code - Material	No. of Circuits	Cable Diameter in mm	Packaging		
mm ²	AWG				3x200m	1x800m	1x1500m
0.34	22	WSOR	3	5.4	1552210001	1552210002	1552210003
			4	5.7	1552210013*	1552210014*	1552210015*
			5	6.1	1552210025*	1552210026*	1552210027*
		PVC	3	5.4	1552110001	1552110002	1552110003
			4	5.7	1552110013*	1552110014*	1552110015*
			5	6.1	1552110025*	1552110026*	1552110027*
		PUR	3	5.4	1552310001	1552310002	1552310003
			4	5.7	1552310013*	1552310014*	1552310015*
			5	6.1	1552310025*	1552310026*	1552310027*

Brad Micro-Change M12 Closure Caps

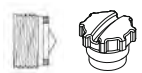

Plastic Closure Cap

To Cover Male		To Cover Female	
Engineering No.	Standard Order No.	Engineering No.	Standard Order No.
—	1203080680	—	1203580007



Rubber Closure Cap with Leash

To Cover Male		To Cover Female	
Engineering No.	Standard Order No.	Engineering No.	Standard Order No.
—	1200765046	—	1200765047

Brad Nano-Change M8 Sensor/Actuator Connectivity

molex

Brad Nano-Change M8 connectivity provides a rugged and space-saving solution to wire a wide range of sensors and actuators from proximity switches to rotary encoders in harsh environments.

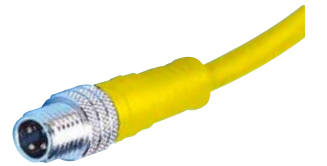

Brad Nano-Change M8 Single-Ended Cordsets



Poles		A10 PVC Cable							
Length	Engineering No.	Female Straight		Female 90°		Male Straight		Male 90°	
		Standard Order No.	Engineering No.	Standard Order No.	Engineering No.	Standard Order No.	Engineering No.	Standard Order No.	
3	1m	403000A10M010	1200860100	403001A10M010	1200860118	403006A10M010	1200860131	403007A10M010	1200860031
	2m	403000A10M020	1200860102	403001A10M020	1200860119	403006A10M020	1200860132	403007A10M020	1200860139
	5m	403000A10M050	1200860107	403001A10M050	1200860122	403006A10M050	1200860134	403007A10M050	1200860141
	10m	403000A10M100	1200860111	403001A10M100	1200860124	403006A10M100	1200860135	403007A10M100	1200860142
4	1m	404000A10M010	1200860143	404001A10M010	1200860174	404006A10M010	1200860182	404007A10M010	1200860051
	2m	404000A10M020	1200860144	404001A10M020	1200860175	404006A10M020	1200860183	404007A10M020	1200860186
	5m	404000A10M050	1200860147	404001A10M050	1200860178	404006A10M050	1200860185	404007A10M050	1200860188
	10m	404000A10M100	1200860155	404001A10M100	1200860180	404006A10M100	1200860577	404007A10M100	1200860605
5	1m	405000A10M010	1200860190	405001A10M010	1200860199	405006A10M010	1200860204	405007A10M010	1200860209
	2m	405000A10M020	1200860191	405001A10M020	1200860200	405006A10M020	1200860206	405007A10M020	1200860210
	5m	405000A10M050	1200860193	405001A10M050	1200860202	405006A10M050	1200860208	405007A10M050	1200860212
	10m	405000A10M100	1200860194	405001A10M100	1200860092	405006A10M100	1200860579	405007A10M100	—

Brad Nano-Change M8 Sensor/Actuator Connectivity

molex

Brad Nano-Change M8 connectivity provides a rugged and space-saving solution to wire a wide range of sensors and actuators from proximity switches to rotary encoders in harsh environments.



Brad Nano-Change M8 Single-Ended Cordsets



B41 WSOR Cable									
Poles	Length	Female Straight		Female 90°		Male Straight		Male 90°	
		Engineering No.	Standard Order No.	Engineering No.	Standard Order No.	Engineering No.	Standard Order No.	Engineering No.	Standard Order No.
3	1m	403000B41M010	1200868655	403001B41M010	1200868667	403006B41M010	1200868631	403007B41M010	1200868643
	2m	403000B41M020	1200868656	403001B41M020	1200868668	403006B41M020	1200868632	403007B41M020	1200868644
	5m	403000B41M050	1200868657	403001B41M050	1200868669	403006B41M050	1200868633	403007B41M050	1200868645
	10m	403000B41M100	1200868658	403001B41M100	1200868670	403006B41M100	1200868634	403007B41M100	1200868646
4	1m	404000B41M010	1200868659	404001B41M010	1200868671	404006B41M010	1200868635	404007B41M010	1200868647
	2m	404000B41M020	1200868660	404001B41M020	1200868672	404006B41M020	1200868636	404007B41M020	1200868648
	5m	404000B41M050	1200868661	404001B41M050	1200868673	404006B41M050	1200868637	404007B41M050	1200868649
	10m	404000B41M100	1200868662	404001B41M100	1200868674	404006B41M100	1200868638	404007B41M100	1200868650
5	1m	405000B41M010	1200868663	405001B41M010	1200868675	405006B41M010	1200868639	405007B41M010	1200868651
	2m	405000B41M020	1200868664	405001B41M020	1200868676	405006B41M020	1200868640	405007B41M020	1200868652
	5m	405000B41M050	1200868665	405001B41M050	1200868677	405006B41M050	1200868641	405007B41M050	1200868653
	10m	405000B41M100	1200868666	405001B41M100	1200868678	405006B41M100	1200868642	405007B41M100	1200868654

Brad Nano-Change M8 Sensor/Actuator Connectivity

molex

Brad Nano-Change M8 connectivity provides a rugged and space-saving solution to wire a wide range of sensors and actuators from proximity switches to rotary encoders in harsh environments.

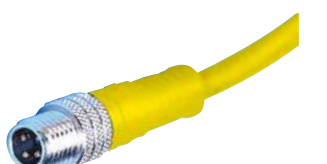

Brad Nano-Change M8 Single-Ended Cordsets



K05 TPE Cable									
Poles	Length	Female Straight		Female 90°		Male Straight		Male 90°	
		Engineering No.	Standard Order No.	Engineering No.	Standard Order No.	Engineering No.	Standard Order No.	Engineering No.	Standard Order No.
3	1m	403000K05M010	1200860508	403001K05M010	1200860614	403006K05M010	1200868520	403007K05M010	1200868524
	2m	403000K05M020	1200860338	403001K05M020	1200860350	403006K05M020	1200868521	403007K05M020	1200868525
	5m	403000K05M050	1200860340	403001K05M050	1200860351	403006K05M050	1200868522	403007K05M050	1200868526
	10m	403000K05M100	1200860342	403001K05M100	1200860352	403006K05M100	1200868523	403007K05M100	1200868527
4	1m	404000K05M010	1200868529	404001K05M010	1200868531	404006K05M010	1200868534	404007K05M010	1200868538
	2m	404000K05M020	1200860369	404001K05M020	1200868532	404006K05M020	1200868535	404007K05M020	1200868539
	5m	404000K05M050	1200860370	404001K05M050	1200860377	404006K05M050	1200868536	404007K05M050	1200868540
	10m	404000K05M100	1200860371	404001K05M100	1200860378	404006K05M100	1200868537	404007K05M100	1200868541

Build-A-Part Number Configuration Code

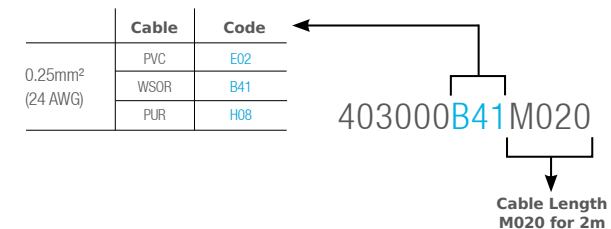

Brad Nano-Change M8 Sensor/Actuator Connectivity

molex

Brad Nano-Change M8 connectivity provides a rugged and space-saving solution to wire a wide range of sensors and actuators from proximity switches to rotary encoders in harsh environments.

Brad Nano-Change M8 Double-Ended Cordsets



A10 PVC Cable					
		Female to Male Straight		Female 90° to Male Straight	
Poles	Length	Engineering No.	Standard Order No.	Engineering No.	Standard Order No.
3	.6m	443030A10M006	1200870071	443031A10M006	1200870242
	1m	443030A10M010	1200870074	443031A10M010	1200870243
	2m	443030A10M020	1200870078	443031A10M020	1200870245
	5m	443030A10M050	1200870081	443031A10M050	1200870248
4	.6m	444030A10M006	1200870092	444031A10M006	1200878583
	1m	444030A10M010	1200870093	444031A10M010	1200870103
	2m	444030A10M020	1200870095	444031A10M020	1200870104
	5m	444030A10M050	1200870098	444031A10M050	1200870107
5	.6m	445030A10M006	1200870677	445031A10M006	1200871019
	1m	445030A10M010	1200870112	445031A10M010	1200870287
	2m	445030A10M020	1200870113	445031A10M020	1200870288
	5m	445030A10M050	1200870041	445031A10M050	1200870289



A10 PVC M8 Cable Specification

For use in packaging machines and production lines in static or less demanding environments.
 Conductors: 3 x 24 or 4 x 24 AWG (Black, Brown, Blue, White)
 Jacket Material: Yellow PVC
 Voltage Rating: 300V, Max 4 Amps
 Operating Temperature: -30 to +80°C
 Diameter 3 pole 4,2 ^{+/-0.3}mm
 Diameter 4 pole 4,6 ^{+/-0.3}mm
 Approvals: UL AWM 2661 / CSA

Brad Nano-Change M8 Sensor/Actuator Connectivity

molex

Brad Nano-Change M8 Double-Ended Cordsets



B41 WSOR Cable					
		Female to Male Straight		Female 90° to Male Straight	
Poles	Length	Engineering No.	Standard Order No.	Engineering No.	Standard Order No.
3	.6m	443030B41M006	1200878703	443031B41M006	1200878721
	1m	443030B41M010	1200878704	443031B41M010	1200878722
	2m	443030B41M020	1200878705	443031B41M020	1200878723
	3m	443030B41M030	1200878706	443031B41M030	1200878724
4	.6m	443030B41M050	1200878707	443031B41M050	1200878725
	1m	444030B41M010	1200878709	444031B41M010	1200878727
	2m	444030B41M020	1200878710	444031B41M020	1200878728
	3m	444030B41M030	1200878711	444031B41M030	1200878729
5	.6m	444030B41M050	1200878712	444031B41M050	1200878730
	1m	444030B41M006	1200878713	444031B41M006	1200878731
	2m	445030B41M010	1200878715	445031B41M010	1200878733
	3m	445030B41M020	1200878716	445031B41M020	1200878734
5	2m	445030B41M030	1200878717	445031B41M030	1200878735
	3m	445030B41M050	1200878718	445031B41M050	1200878736
	5m	445030B41M050	1200878719	445031B41M050	1200878737



B41 WSOR Cable Specification*

Conductors: 3x0,25 mm², 4x0,25 mm², 5x0,25 mm², 8x0,25 mm²
 (Brown, White, Blue, Black, Grey)
 (BN, WH, BE, RD, GY, GN, YE, PK)
 Jacket material: Black WSOR, flame retardant, oil, UV & Weld Slag resistant, silicone & FCKW free
 Diameter 3 Pole: 4,5 ^{+/-0.2}mm
 Diameter 4 Pole: 4,8 ^{+/-0.2}mm
 Diameter 5 Pole: 5,3 ^{+/-0.2}mm
 Diameter 8 Pole: 6,4 ^{+/-0.2}mm
 Voltage Rating: 600V
 Static Operating Temp: -40 to +90°C
 Dynamic Operating Temp: -25 to +80°C
 Drag Chain (20 Mio cycles at 15xO.D.) & torsion suitable
 Approvals: UL AWM Style 21215 / CSA

B41 Raw cable ordering information

Poles	Size	Standard Order No.
3 Poles	3x200m	1552200001
	1x800m	1552200002
	1x1500m	1552200003
4 Poles	3x200m	1552200013
	1x800m	1552200014
	1x1500m	1552200015
5 Poles	3x200m	1552200025
	1x800m	1552200026
	1x1500m	1552200027
8 Poles	3x100m	1552200034
	1x500m	1552200035
	1x1000m	1552200036
12 Poles	3x100m	1552200043
	1x500m	1552200044
	1x1000m	1552200045

Brad Nano-Change M8 Sensor/Actuator Connectivity

molex



Brad Nano-Change M8 Double-Ended Cordsets



K05 TPE Cable					
Poles	Length	Female to Male Straight		Female 90° to Male Straight	
		Engineering No.	Standard Order No.	Engineering No.	Standard Order No.
3	.6m	443030K05M006	1200868544	443031K05M006	1200868545
	1m	443030K05M010	1200870235	443031K05M010	1200870485
	2m	443030K05M020	1200870236	443031K05M020	1200870486
	5m	443030K05M050	1200871000	443031K05M050	1200868546
4	.6m	444030K05M006	1200868547	444031K05M006	1200868549
	1m	444030K05M010	1200870999	444031K05M010	1200868550
	2m	444030K05M020	1200868548	444031K05M020	1200868551
	5m	444030K05M050	1200870992	444031K05M050	1200868552

K05 TPE M8 Cable Specification

For use in machine tools, metal cutting production with harsh fluid, mechanical or continuous flex requirements.

Conductors: 3 x 22 or 4 x 22 AWG (Black, Brown, Blue, White)

Jacket Material: Yellow TPE

Voltage Rating: 300V, Max 4 Amps

Operating Temperature:

-30 to +80°C

Bending Cycles: 20 Mio cycles at 15xO.D.

Diameter 3 pole 5,0 ^{+/-0.2}mm

Diameter 4 pole 5,2 ^{+/-0.2}mm

Approvals: UL PLTC, CSA FT4

K05 Raw cable ordering information

Poles	Size	Standard Order No.
3 Poles	3x200m	1552408001
	1x800m	1552408002
	1x1500m	1552408003
4 Poles	3x200m	1552408004
	1x800m	1552408005
	1x1500m	1552408006
5 Poles	3x100m	1552408007
	1x500m	1552408008
	1x1000m	1552408009

Brad Nano-Change M8 Sensor/Actuator Connectivity

molex

Brad Nano-Change M8 Receptacles



Poles	Front Mounting	Male		Female	
		Engineering No.	Standard Order No.	Engineering No.	Standard Order No.
3	M8x0.5	4R3P06A27C300	1200900020	4R3P00A27C300	1200900016
4	M8x0.5	4R4P06A27C300	1200900032	4R4P00A27C300	1200900029
5	M8x0.5	4R5P06A27C300	1200900038	4R5P00A27C300	1200900037

Brad Nano-Change M8 Sensor/Actuator Connectivity

molex



Brad Nano-Change M8 Field Attachable Connectors



			Male Straight		Female Straight	
Poles	Cable Size	Wire Gage	Engineering No.	Standard Order No.	Engineering No.	Standard Order No.
Unshielded & soldering termination						
3	3.5-5.0	AWG 24	N03MA03124	1200910004	N03FA03124	1200910001
4	3.5-5.0	AWG 24	N04MA03124	1200910010	N04FA03124	1200910007
Unshielded & Screw termination						
3	3.5-5.0	AWG26-20	N03MA03134	1200910023	N03FA03134	1200910024
4	3.5-5.0	AWG26-20	N04MA03134	1200910025	N04FA03134	1200910026
Unshielded & IDC termination						
3	2.5-5.2	AWG24-20	N03MA03144	1200910027	N03FA03144	1200910028
4	2.5-5.2	AWG24-20	N04MA03144	1200910029	N04FA03144	1200910030



			Male 90°		Female 90°	
Poles	Cable Size	Wire Gage	Engineering No.	Standard Order No.	Engineering No.	Standard Order No.
Unshielded & soldering termination						
3	3.5-5.0	AWG 24	N03MA04124	1200910002	N03FA04124	1200910003
4	3.5-5.0	AWG 24	N04MA04124	1200910012	N04FA04124	1200910009

Nano-Change M8 Connector Pinout (front view)

3 Pole

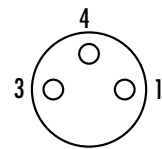

1 - Brown 4 - Black
3 - Blue

4 Pole

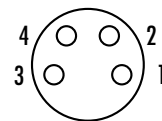

1 - Brown 3 - Blue
2 - White 4 - Black

5 Pole

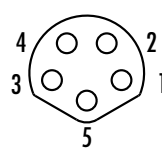

1 - Brown 4 - Black
2 - White 5 - Grey
3 - Blue

Brad Nano-Change M8 Sensor/Actuator Connectivity

molex



Flamar Unshielded Signal & Control Cable Reels

Cross Section		Cable Code - Material	No. of Circuits	Cable Diameter in mm	Packaging		
mm ²	AWG				3x200m	1x800m	1x1500m
0.25	24	WSOR	3	4.5	1552200001	1552200002	1552200003
			4	4.8	1552200013	1552200014	1552200015
			5	5.3	1552200025	1552200026	1552200027
		PVC	3	4.5	1552100001	1552100002	1552100003
			4	4.8	1552100013	1552100014	1552100015
			5	5.3	1552100025	1552100026	1552100027
		PUR	3	4.5	1552300001	1552300002	1552300003
			4	4.8	1552300013	1552300014	1552300015
			5	5.3	1552300025	1552300026	1552300027

Brad Nano-Change M8 Closure Caps

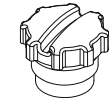

Plastic Closure Cap

To Cover Female	
Engineering No.	Standard Order No.
AG15042	1203080677

Brad mPm DIN Valve Connectors

molex

molex

The mPm connectors with molded-in cable are suitable for use with most types of solenoid. They offer a fast and efficient method of connection resulting in greatly reduced installation time and costs.



Brad mPm DIN Valve Connectors Over Molded to M12 Male Connector

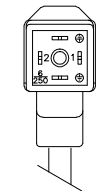
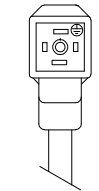
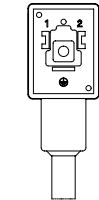
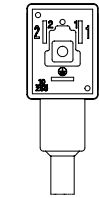
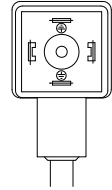

DIN Valve Connector, FORM A, C4 Circuit, Ground Pos H6/H12				
Length	Male Straight		Male 90°	
	Engineering No.	Standard Order No.	Engineering No.	Standard Order No.
.6m	E850B0P12M006	1210360192	E850B2P12M006	1210360208
1m	E850B0P12M010	1210360193	E850B2P12M010	1210360209
1.5m	E850B0P12M015	1210360194	E850B2P12M015	1210360821
3m	E850B0P12M030	1210360356	E850B2P12M030	1210360211

DIN Valve Connector, FORM Industrial, C4 Circuit, Ground Pos H6				
Length	Male Straight		Male 90°	
	Engineering No.	Standard Order No.	Engineering No.	Standard Order No.
.6m	F850B0P12M006	1210360352	F850B2P12M006	1210360505
1m	F850B0P12M010	1210360255	F850B2P12M010	1210360506
1.5m	F850B0P12M015	1210360822	F850B2P12M015	1210360823
3m	F850B0P12M030	1210360257	F850B2P12M030	1210360824

DIN Valve Connector, FORM B, C4 Circuit, Ground Pos H6				
Length	Male Straight		Male 90°	
	Engineering No.	Standard Order No.	Engineering No.	Standard Order No.
.6m	D850B0P12M006	1210360056	D850B2P12M006	1210360828
1m	D850B0P12M010	1210360825	D850B2P12M010	1210360829
1.5m	D850B0P12M015	1210360826	D850B2P12M015	1210360830
3m	D850B0P12M030	1210360827	D850B2P12M030	1210360831

DIN Valve Connector, FORM C, C4 Circuit, Ground Pos H6/H12				
Length	Male Straight		Male 90°	
	Engineering No.	Standard Order No.	Engineering No.	Standard Order No.
.6m	H850B0P12M006	1210360295	H850B2P12M006	1210360832
1m	H850B0P12M010	1210360296	H850B2P12M010	1210360305
1.5m	H850B0P12M015	1210360471	H850B2P12M015	1210360833
3m	H850B0P12M030	1210360440	H850B2P12M030	1210360834

DIN Valve Connector, FORM Micro, C4 Circuit, Ground Pos H6/H12				
Length	Male Straight		Male 90°	
	Engineering No.	Standard Order No.	Engineering No.	Standard Order No.
.6m	G850B0P12M006	1210360406	G850B2P12M006	1210360836
1m	G850B0P12M010	1210360277	G850B2P12M010	1210360621
1.5m	G850B0P12M015	1210360835	G850B2P12M015	1210360837
3m	G850B0P12M030	1210360481	G850B2P12M030	1210350270

DIN PUR/PVC Cable Specification

Conductors: 3x0,5mm² PVC
(Brown, Blue, Green/Yellow)
Jacket Material: Black PUR
Voltage Rating: 300V
Operating Temperature:
-5 to +90°C (flexing)
-30 to +90°C (static)
Diameter: 5,5 ± 0,3 mm

Note:

The mPm DIN valve over molded cordsets are available in various versions, Pole count, housing, cable, lengths and electronics. For further information consult our website or automation catalog or your local sales support.

Further technical information, datasheet or drawing can be downloaded from the Molex website using the ordering part number.



Power Distribution Connectivity

BradPower for motor branch circuits

Dedicated +24VDC power supply for 60mm HarshIO modules.

- 600V AC/DC
- up to 32 Amps
- up to 10 AWG wires
- 3 and 4 pole versions

Brad Mini-Change 7/8" for power distribution

Dedicated +24VDC power supply for 60mm HarshIO modules.

- Up to 8 Amps UL per contacts
- 16 AWG Wires (1.5mm²) for low voltage drop
- 5 Poles version

Solution also available as 4 Pole for +24VDC as well as alternative current supply or as 3 Poles for 230VAC + GND.

Brad Micro-Change M12 A-Code for power distribution

Dedicated +24VDC power supply for 30mm HarshIO modules.

- Up to 4 Amps UL per contacts
- 22 AWG Wires (0.34mm²)
- 5 Poles version



Further Industrial power connectors from Molex

Brad Power

Find the full catalog here: www.molex.com/BradPower



Brad Power Solutions
987651-7951



GWconnect Heavy Duty Connector

Rectangular connector for high density and modular connectivity applications up to 100 Amps according to inserts and contacts used.

For more information about these additional connectors from Molex consult our web page.



Fast check fold out
987651-1521



BradPower Modular Power Solutions

Bottom-Line Benefits

Compared to traditional, conduit-based hard wiring, BradPower modular solutions provide a host of operational advantages, including:

- Reduce wiring errors (the #1 added expense)
- Reduce skilled labor costs
- Reduce maintenance and operating costs
- Increase plant equipment flexibility
- Speed up delivery and commissioning of new equipment
- NFPA-79-2015 Standard Compliant

Modular, Easy to Install

BradPower solutions from Molex replace machine hard wiring with modular quick-connect systems comprised of crush resistant, factory-molded, cord sets and connectors. The result is a robust, scalable, and easy-to-install power distribution system that does not require the specialized tools and labor typically associated with traditional conduit or raceway installations.

Performance

BradPower's modular components make installation faster, easier, and more reliable. Where multiple machines are involved, assembling the systems is consistent and repeatable.

BradPower systems meet ALL of the same requirements as hard-wiring and they deliver the same unsurpassed performance and innovation the industry has come to expect from the Brad® brand.

Stainless Steel options for Food & Beverage/Pharmaceutical Applications

- Smooth over molds designed to eliminate food traps
- 316 Stainless Steel coupling nuts for maximum corrosion resistance
- IP69K-rated environmental performance, ideal for high pressure, high temperature wash-down

molex

molex

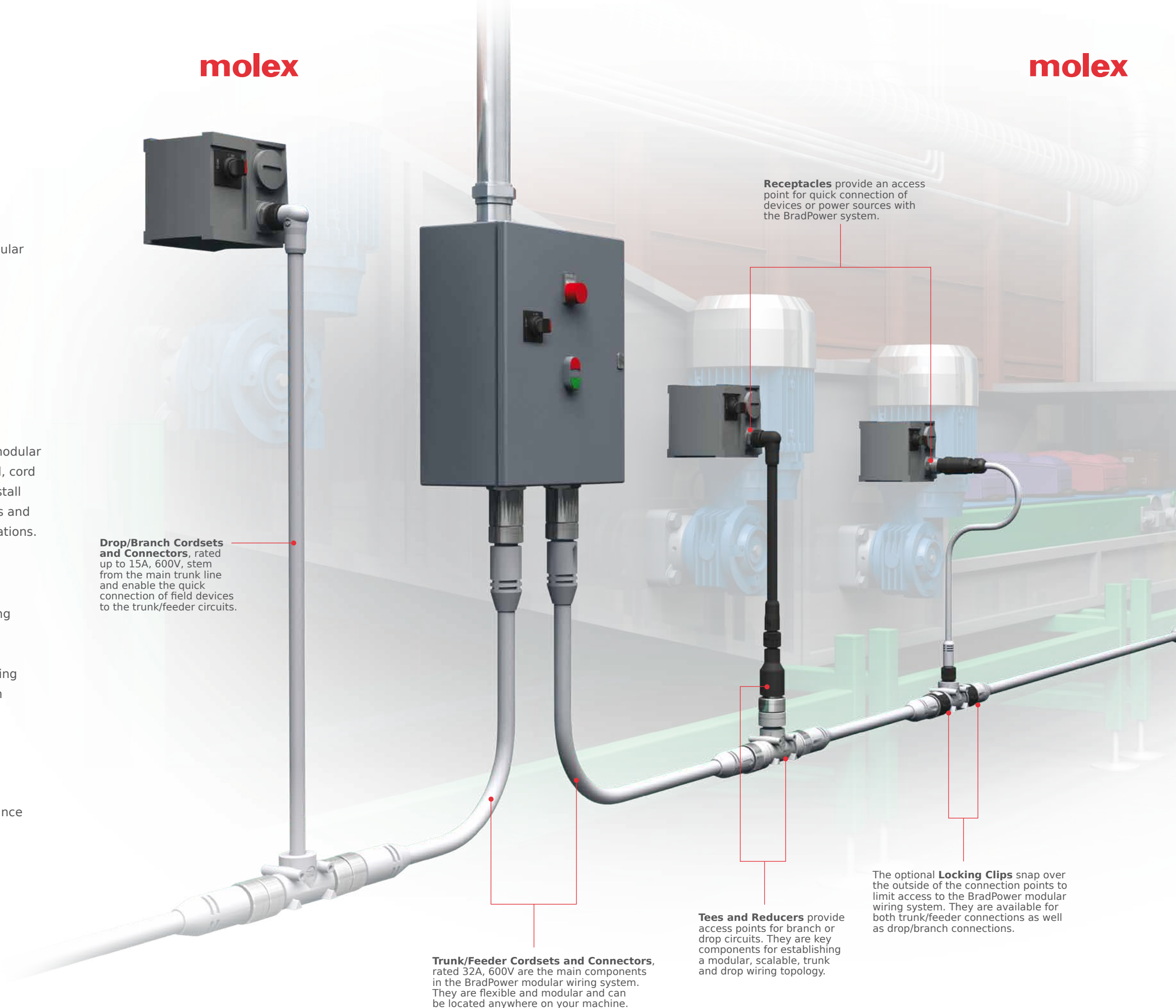

Drop/Branch Cordsets and Connectors, rated up to 15A, 600V, stem from the main trunk line and enable the quick connection of field devices to the trunk/feeder circuits.

Receptacles provide an access point for quick connection of devices or power sources with the BradPower system.

Trunk/Feeder Cordsets and Connectors, rated 32A, 600V are the main components in the BradPower modular wiring system. They are flexible and modular and can be located anywhere on your machine.

Tees and Reducers provide access points for branch or drop circuits. They are key components for establishing a modular, scalable, trunk and drop wiring topology.

The optional **Locking Clips** snap over the outside of the connection points to limit access to the BradPower modular wiring system. They are available for both trunk/feeder connections as well as drop/branch connections.

Specifications

MECHANICAL

Molded Connector: Black (4 pole), Red (3 pole) Oil-Resistant TPE
Coupling Nut: Clear Anodized Aluminum or Black epoxy coated Zinc
Cable: Black TPE jacketed UL Type TC-ER
Minimum Bend Radius: 10x Cable Diameter

ELECTRICAL

Contact: Copper Alloy with Gold over Nickel Plating
Current: 32A Trunk, 15A Drop
Voltage: 600V AC/DC

ENVIRONMENTAL

Enclosure Rating (Mated): IP67, UL Type 4/12
Operating Temperature: -20°C to +90°C
RoHS: Compliant

CERTIFICATIONS

UL Listed per UL 2237, E258922, Category PVVA for Industrial Machinery
Meets NFPA 79 – 2018 Standards for Industrial Machinery and Motor Branch Circuits



BradPower D-Size (1 3/8" – M35), 3 pole Double-Ended Trunk Patchcords

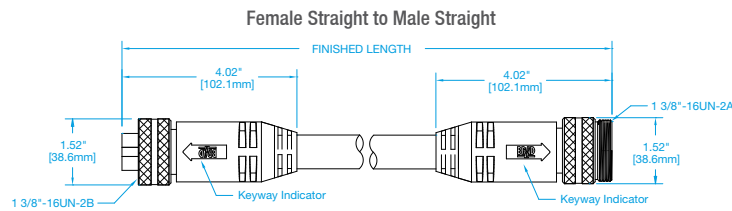

Length	Engineering No.	Standard Order No.
1m	CC3030K19M010E	1300640447
2m	CC3030K19M020E	1300640437
3m	CC3030K19M030E	1300640448
5m	CC3030K19M050E	1300640450
10m	CC3030K19M100E	1300640452

BradPower D-Size (1 3/8" – M35), 3 pole Tee

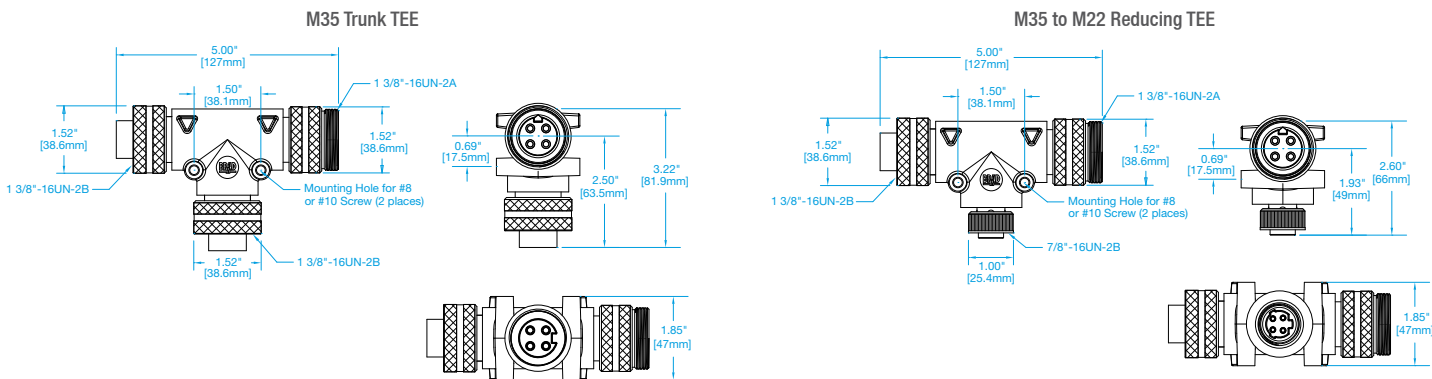

Engineering No.	Standard Order No.	Engineering No.	Standard Order No.
TC30C30-200E	1300680104	TC30130-200E	1300680105

BradPower A-Size (7/8" – M22), 3 pole Double-Ended Drop Patchcords

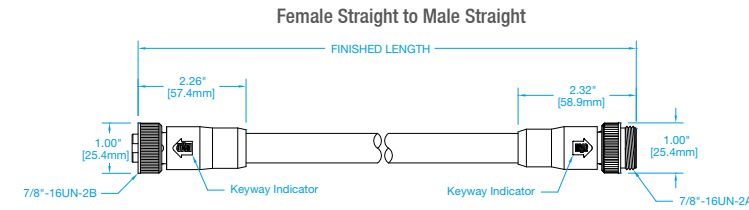

Length	Engineering No.	Standard Order No.
1m	113030K20M010E	1300621011
2m	113030K20M020E	1300621009
3m	113030K20M030E	1300621012
5m	113030K20M050E	1300621014
10m	113030K20M100E	1300621016

BradPower D-Size (1 3/8" – M35), 3 pole Trunk Receptacles

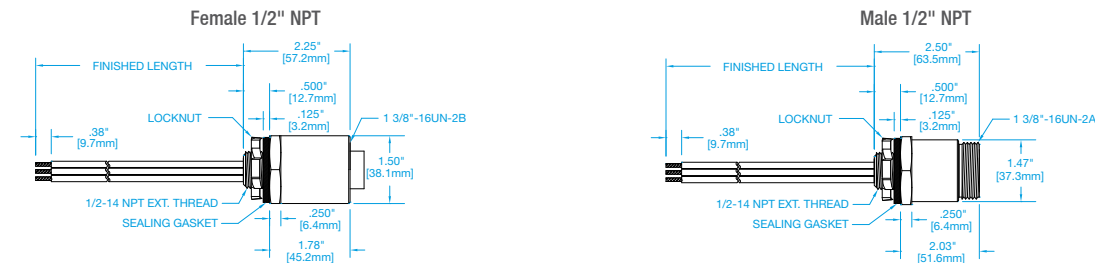

Female		Male	
Engineering No.	Standard Order No.	Engineering No.	Standard Order No.
CR3000A30M005	1300660110	CR3006A30M005	1300660255

BradPower A-Size (7/8" – M22), 3 pole Drop Receptacles

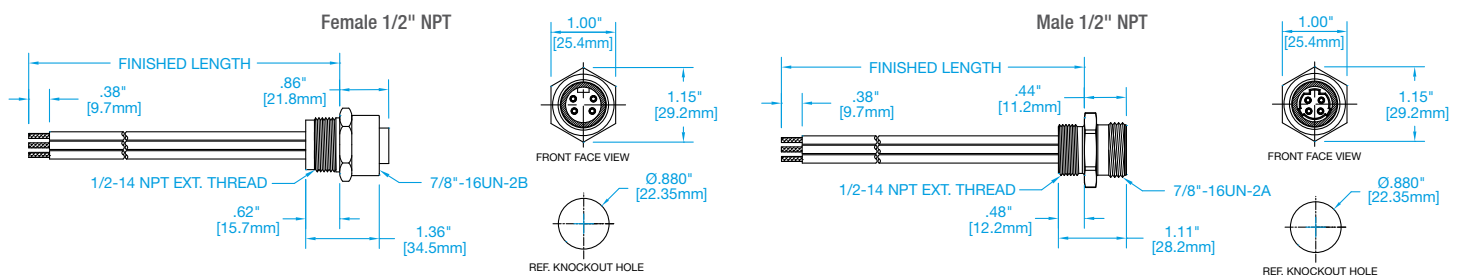

Female		Male	
Engineering No.	Standard Order No.	Engineering No.	Standard Order No.
1R3000A28M005G	1300660035	1R3006A28M005G	1300660050

BradPower Modular Power Solutions

molex

BradPower D-Size (1 3/8" – M35), 4 pole Double-Ended Trunk Patchcords

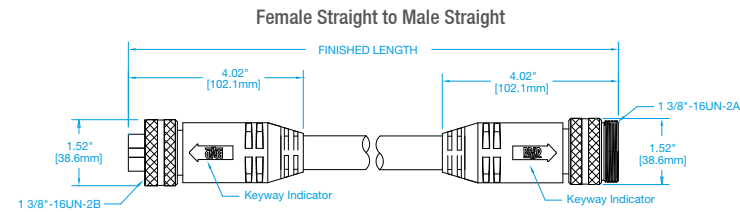

Length	Engineering No.	Standard Order No.
1m	CC4030K17M010G	1300640453
2m	CC4030K17M020G	1300640438
3m	CC4030K17M030G	1300640439
5m	CC4030K17M050G	1300640455
10m	CC4030K17M100G	1300640458

BradPower D-Size (1 3/8" – M35), 4 pole Tee

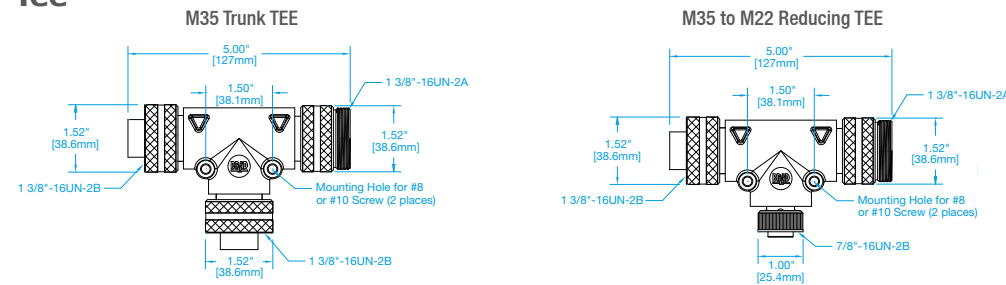

Engineering No.	Standard Order No.	Engineering No.	Standard Order No.
TC40C40-200G	1300680099	TC40I40-200G	1300680106

BradPower A-Size (7/8" – M22), 4 pole Double-Ended Drop Patchcords

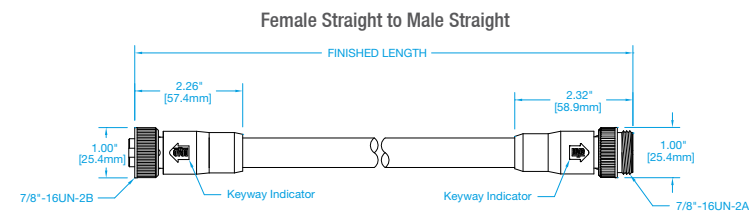

Length	Engineering No.	Standard Order No.
1m	114030K21M010G	1300621018
2m	114030K21M020G	1300621028
3m	114030K21M030G	1300621029
5m	114030K21M050G	1300621030
10m	114030K21M100G	1300621066

BradPower Modular Power Solutions

molex

BradPower D-Size (1 3/8" – M35), 4 pole Trunk Receptacles

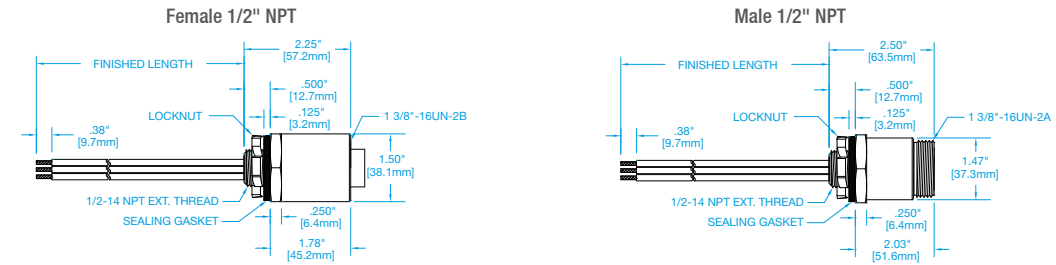

Female		Male	
Engineering No.	Standard Order No.	Engineering No.	Standard Order No.
CR4000A76M005	1300660235	CR4006A76M005	1300660236

BradPower A-Size (7/8" – M22), 3 pole Drop Receptacles

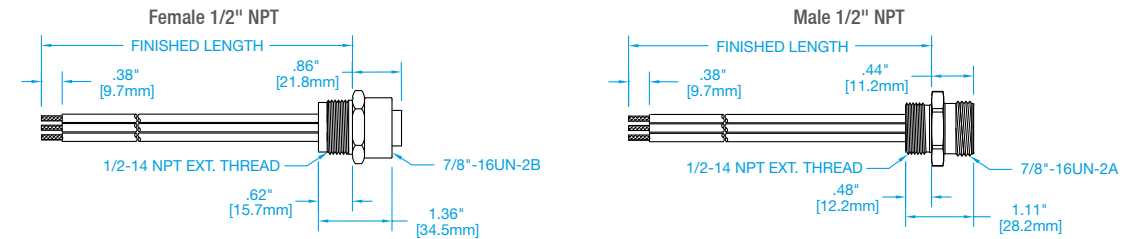

Female		Male	
Engineering No.	Standard Order No.	Engineering No.	Standard Order No.
1R4000A28M005G	1300660069	1R4006A28M005G	1300660090

BradPower Modular Power Solutions

molex

BradPower C-Size (1 1/8" – M29) 4 pole Double ended cordsets

For use with Rockwell ArmorStart ST variable frequency drives or motor starters.

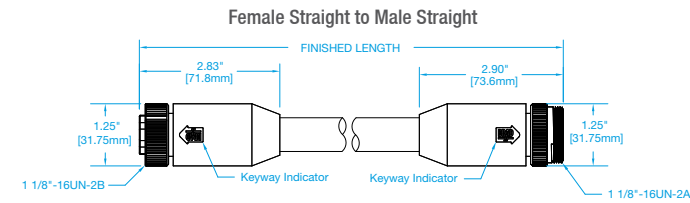

Length	Engineering No.	Standard Order No.
1m	334T30K26M010A3	1300621121
2m	334T30K26M020A3	1300620300
3m	334T30K26M030A3	1300621113
5m	334T30K26M050A3	1300621120
10m	334T30K26M100A3	1300621117

BradPower C-Size (1 1/8" – M29) Receptacles

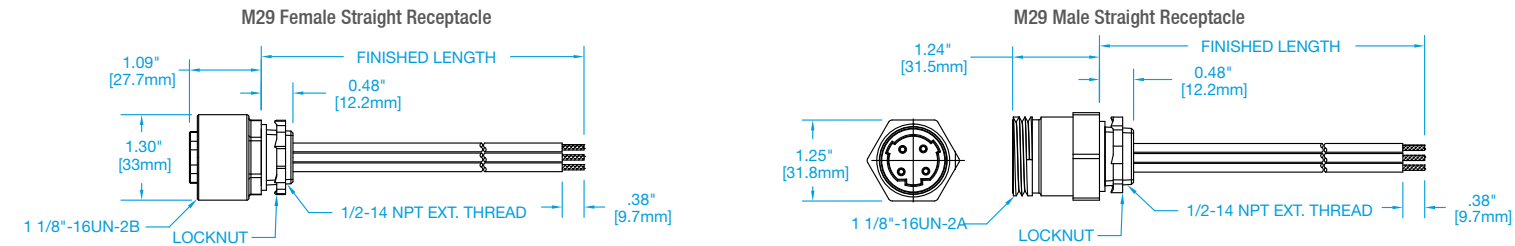

Female		Male	
Engineering No.	Standard Order No.	Engineering No.	Standard Order No.
3R4100A84M0053	1300662018	3R4106A84M0053	1300662014

BradPower Accessories

molex

BradPower Field Attachable Connectors

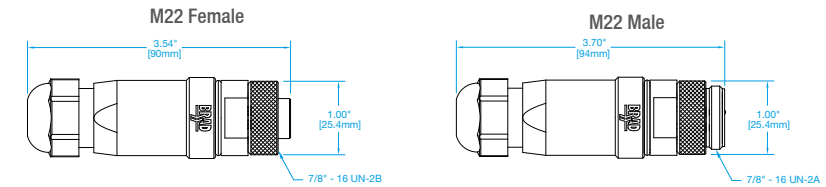

D-Size (1 3/8" – M35)				
	Female		Male	
Poles	Engineering No.	Standard Order No.	Engineering No.	Standard Order No.
3	CA3000-39	1300700021	CA3006-39	1300700022
4	CA4000-39	1300700023	CA4006-39	1300700024

A-Size (7/8" – M22)				
	Female		Male	
Poles	Engineering No.	Standard Order No.	Engineering No.	Standard Order No.
3	1A3000-34PWR	1300170055	1A3006-34PWR	1300170056
4	1A4000-34PWR	1300170057	1A4006-34PWR	1300170058

Closure Caps and Locking Clips

Size	Gender	Bead Chain	Closure Cap Threads	Engineering No.	Standard Order No.
D-Size (1 3/8" – M35)	Male (Mates with Female Connector)	No	External	55-0198	1300700018
	Female (Mates with Male Connector)	No	Internal	55-0298	1300700019
A-Size (7/8" – M22)	Male (Mates with Female Connector)	Yes	External	65-0085	1302011109
	Female (Mates with Male Connector)	Yes	Internal	65-0086	1302011111

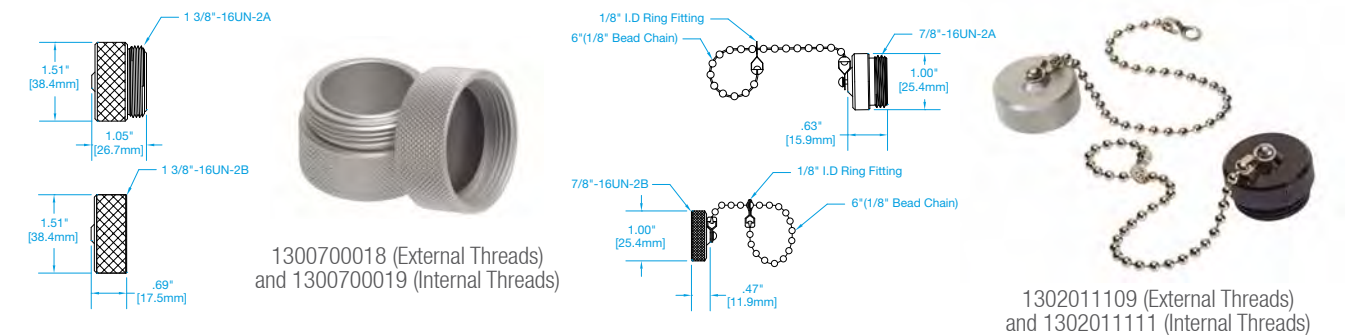

Locking Clips

Size	Quantity Per Bag	Warning Label	Engineering No.	Standard Order No.
D-Size (1 3/8" – M35)	10		66200A-10	1300700020
A-Size (7/8" – M22)	10		11400A-10	1300700012



Dimensions in inches [millimeters]. Dimensions not to be used for manufacturing purposes and are subject to change.

Brad Mini-Change (7/8") Auxiliary Power Infrastructure Connectivity

molex

Plug & Play 3 Pole in support of 120 VAC power distribution infrastructure to connect IP67 devices based on the Mini-Change (7/8") connection system.

Brad Mini-Change (7/8") Single-Ended 3 Pole Cordsets



3 Pole Mini-Change Auxiliary Power TPE Cable				
	Male Straight		Female Straight	
Length	Engineering No.	Standard Order No.	Engineering No.	Standard Order No.
2m	103006K13M020	1300062456	103000K13M020	1300062383
5m	103006K13M050	1300062459	103000K13M050	1300069041
10m	103006K13M100	1300062462	103000K13M100	1300060419

Brad Mini-Change (7/8") Double-Ended 3 Pole Cordsets



3 Pole Mini-Change Auxiliary Power TPE Cable		
	Female Straight to Male Straight	
Length	Engineering No.	Standard Order No.
1m	113030K13M010	1300100487
2m	113030K13M02	1300100488
5m	113030K13M050	1300100491
10m	113030K13M100	1300105001
20m	113030K13M200	1300105002

Brad Mini-Change (7/8") 3 Pole Receptacles*



3 Pole Mini-Change Auxiliary Power PVC Wires				
	Male Receptacle		Female Receptacle	
Length	Engineering No.	Standard Order No.	Engineering No.	Standard Order No.
1m	1R3006A20M010	1300130223	1R3000A20M010	1300130111
2m	1R3006A20M020	1300130224	1R3000A20M020	1300130112

** Gasket and Locknut Sold Separately.
Gasket: 130180-0059
1/2" NPT Locknut: 130184-0031



K13-3 TPE Cable Specification

Conductors: 3 x 16 AWG (1.5mm²)
Jacket Material: TPE
Jacket Color: Yellow
Voltage Rating: 600 VAC/VDC
Max. Current: 13A
Temperature Range: -40°C to 90°C (-40°F to 194°F)
C-Track & Torsional Flex Test: 20 Million Cycles
Cable O.D: ø 0.405" (10.28mm)
Minimum Bend Radius: 10x cable diameter
Approvals: UL Listed TC-ER

Mini-Change® 3 Pole Female Connector Pinout (Front view)

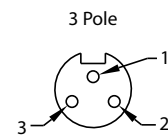

1. Green/Yellow
2. Black
3. White

Raw Cable Ordering Information (250 FT)

K13-3 Yellow TPE: 130209-0010

Brad Mini-Change (7/8") Auxiliary Power Infrastructure Connectivity

molex



Brad Mini-Change 3 Pole Field Attachable Connector



Male		Female	
Engineering No.	Standard Order No.	Engineering No.	Standard Order No.
1A3006-34	1300170011	1A3000-34	1300170004

Brad Mini-Change 3 Pole Tees

Mini-Change Tee	
Male	
Engineering No.	Standard Order No.
61056	1300180217

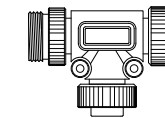

Mini-Change Distribution Box		
Description	Engineering No.	Standard Order No.
4 Ports	ACAUX4000	1300600067
6 Ports	ACAUX8000	1300600068

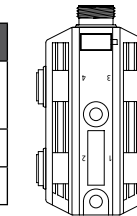

Brad Mini-Change Accessories

Mini-Change Caps		
Description	Engineering No.	Standard Order No.
Int. Thread	65-0086	1302011111
Ext. Thread	65-0085	1302011109

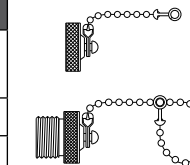

3 Pole Mini-Change Tee, Y-Splitter and Distribution Box Wiring

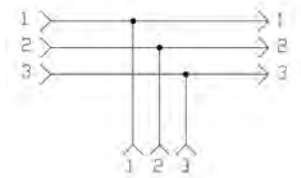

Note:
Further technical information, datasheet or drawing can be downloaded from the Molex website using the Standard Order part number listed.

Brad Mini-Change (7/8") Auxiliary Power Infrastructure Connectivity

Plug & Play 4 Pole 24VDC power distribution infrastructure to connect IP67 devices in support of EtherNet IP/DeviceNet based on the Mini-Change (7/8") connection system.

molex



Mini-Change (7/8") Single-Ended 4 Pole Cordsets

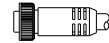
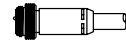

4 Pole Mini-Change Auxiliary Power TPE Cable				
	Male Straight		Female Straight	
Length	Engineering No.	Standard Order No.	Engineering No.	Standard Order No.
2m	104006K12M020	1300062184	104000K12M020	1300062166
5m	104006K12M050	1300062183	104000K12M050	1300060895
10m	104006K12M100	1300062376	104000K12M100	1300060897

Mini-Change (7/8") Double-Ended 4 Pole Cordsets

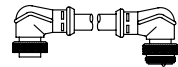

4 Pole Mini-Change Auxiliary Power TPE Cable				
	Female Straight to Male Straight		Female 90° to Male 90°	
Length	Engineering No.	Standard Order No.	Engineering No.	Standard Order No.
1m	114030K12M010	1300100864	114033K12M010	1300100982
2m	114030K12M020	1300100865	114033K12M020	1300101744
5m	114030K12M050	1300100868	114033K12M050	1300101747
10m	114030K12M100	1300100873	114033K12M100	1300101905
20m	114030K12M200	1300100882	114033K12M200	1300101908

Mini-Change (7/8") 4 Pole Receptacles

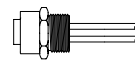
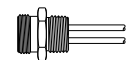

4 Pole Mini-Change Auxiliary Power PVC Wires				
	Male Receptacle		Female Receptacle	
Length	Engineering No.	Standard Order No.	Engineering No.	Standard Order No.
1m	1R4006A39M010	1300130377	1R4000A39M010	1300130300
2m	1R4006A39M020	1300130378	1R4000A39M020	1300130301

* Gasket and Locknut Sold Separately.
Gasket: 130180-0059
1/2" NPT Locknut: 130184-0031

Brad Mini-Change (7/8") Auxiliary Power Infrastructure Connectivity

molex



Brad Mini-Change 4 Pole Field Attachable Connector

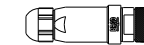
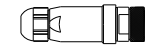

Male		Female	
Engineering No.	Standard Order No.	Engineering No.	Standard Order No.
1A4006-34	1300170020	1A4000-34	1300170015

4 Pole Mini-Change Tee, Y-Splitter and Distribution Box Wiring

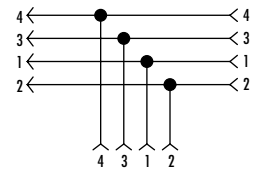

Note:
Further technical information, datasheet or drawing can be downloaded from the Molex® website using the Standard Order part number listed.

K12-4 TPE Cable Specification

Conductors: 4 x 16 AWG (1.5mm²)
Jacket Material: TPE
Jacket Color: Yellow
Voltage Rating: 600 VAC/VDC
Max. Current: 10A
Temperature Range: -20°C to 90°C (-4°F to 194°F)
C-Track & Torsional Flex Test: 20 Million Cycles
Cable O.D: ø 0.430" (10.92mm)
Minimum Bend Radius: 10x cable diameter
Approvals: UL Listed TC-ER

Mini-Change 4 Pole Female Connector Pinout (Front view)

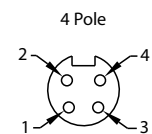

1. Brown
2. White
3. Blue
4. Black

Raw Cable Ordering Information (250 FT)

K12-4 Yellow TPE: 130210-0018

Brad Mini-Change 4 Pole Tees

Mini-Change Tee	
Male	
Engineering No.	Standard Order No.
DNETAUXPT	1300350085

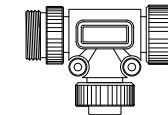

Mini-Change Distribution Box		
Description	Engineering No.	Standard Order No.
4 Ports	DNAUX4000	1300600065
6 Ports	DNAUX8000	1300600066

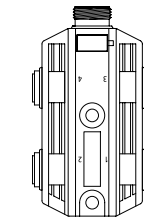

Brad Mini-Change Accessories

Mini-Change Caps		
Description	Engineering No.	Standard Order No.
Int. Thread	65-0086	1302011111
Ext. Thread	65-0085	1302011109

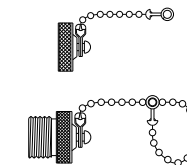

Brad Mini-Change (7/8") Auxiliary Power Infrastructure Connectivity

molex

Plug & Play 5 Pole 24VDC power distribution infrastructure to connect IP67 devices in support of PROFINET/PROFIBUS based on the Mini-Change (7/8") connection system.

Brad Mini-Change (7/8") Single-Ended 5 Pole Cordsets



5 Pole Mini-Change Auxiliary Power TPE Cable				
	Male Straight		Female Straight	
Length	Engineering No.	Standard Order No.	Engineering No.	Standard Order No.
2m	105006K13M020	1300062558	105000K13M020	1300060049
5m	105006K13M050	1300069050	105000K13M050	1300060051
10m	105006K13M100	1300069051	105000K13M100	1300060052

Brad Mini-Change (7/8") Double-Ended 5 Pole Cordsets



5 Pole Mini-Change Auxiliary Power TPE Cable				
	Female Straight to Male Straight		Female 90° to Male 90°	
Length	Engineering No.	Standard Order No.	Engineering No.	Standard Order No.
1m	115030K13M010	1300100102	115033K13M010	1300100118
2m	115030K13M020	1300100103	115033K13M020	1300100119
5m	115030K13M050	1300100105	115033K13M050	1300100121
10m	115030K13M100	1300100106	115033K13M100	1300100122
20m	115030K13M200	1300101843	115033K13M200	1300101960

Brad Mini-Change (7/8") 5 Pole Receptacles



5 Pole Mini-Change Auxiliary Power PVC Wires				
	Male Receptacle		Female Receptacle	
Length	Engineering No.	Standard Order No.	Engineering No.	Standard Order No.
1m	1R5006A20M010	1300130511	1R5000A20M010	1300130425
2m	1R5006A20M020	1300130512	1R5000A20M020	1300130426

* Gasket and Locknut Sold Separately.
Gasket: 130180-0059
1/2" NPT Locknut: 130184-0031



K13-5 TPE Cable Specification

Conductors: 5 x 16 AWG (1.5mm²)
Jacket Material: TPE
Jacket Color: Yellow
Voltage Rating: 600 VAC/VDC
Max. Current: 8A
Temperature Range: -40°C to 90°C (-40°F to 194°F)
C-Track & Torsional Flex Test: 20 Million Cycles
Cable O.D: ø 0.401" (10.18mm)
Minimum Bend Radius: 10x cable diameter
Approvals: UL listed TC-ER

Mini-Change 5 Pole Female Connector Pinout (Front view)

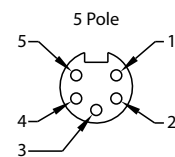

1. White
2. Red
3. Green/Yellow
4. Orange
5. Black

Raw Cable Ordering Information (250 FT)

K13-5 Yellow TPE: 130211-0122

Brad Mini-Change (7/8") Auxiliary Power Infrastructure Connectivity

molex



Brad Mini-Change 5 Pole Field Attachable Connector



Male		Female	
Engineering No.	Standard Order No.	Engineering No.	Standard Order No.
1A5006-34	1300170029	1A5000-34	1300170023

Brad Mini-Change 5 Pole Tees

Mini-Change Tee	
Engineering No.	Standard Order No.
PBAPT	1201010001

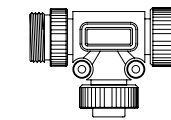

Mini-Change Y-Splitter	
Engineering No.	Standard Order No.
DN3200	1300350071

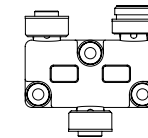

Mini-Change Tee w/M12 Drop	
Engineering No.	Standard Order No.
DND3020	1300390341

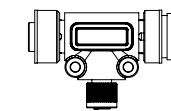

Mini-Change Distribution Box		
Description	Engineering No.	Standard Order No.
2 Ports	DN2100	1300390336
4 Ports	DN4000	1300360005
6 Ports	DN6000	1300360008

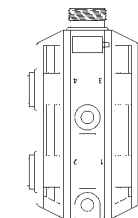

Brad Mini-Change Accessories

Mini-Change Caps		
Description	Engineering No.	Standard Order No.
Int. Thread	65-0086	1302011111
Ext. Thread	65-0085	1302011109

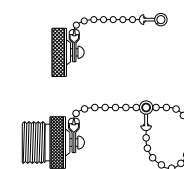

Mini-Change 5 Pole Female Connector Pinout (Front view)

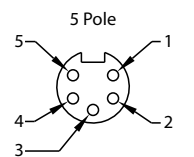

1. Black – Output Power V-
2. Blue – Bus Power V-
3. Green/Yellow – Ground
4. Brown – Bus Power V+
5. White – Output Power V+

5 Pole Mini-Change Tee, Y-Splitter and Distribution Box Wiring

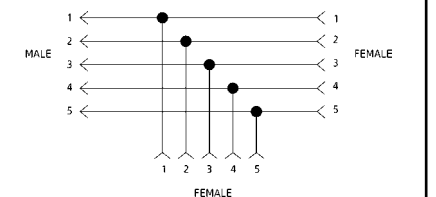

Note:

Further technical information, datasheet or drawing can be downloaded from the Molex® website using the Standard Order part number listed.

Brad Mini-Change (7/8") Connectivity for Industrial Applications

molex



Brad Mini-Change (7/8") Single-Ended Cordsets

Internal thread couplers used on both male and female cord sets

Single-Ended Mini-Change PVC Cable							
Poles	Length	Male Straight		Female Straight		Female 90°	
		Engineering No.	Standard Order No.	Engineering No.	Standard Order No.	Engineering No.	Standard Order No.
3P	3F	103002A01F030	1300060529	103000A01F030	1300060217	103001A01F030	1300060422
	6F	103002A01F060	1300060534	103000A01F060	1300060221	103001A01F060	1300060426
	12F	103002A01F120	1300060542	103000A01F120	1300060232	103001A01F120	1300060430
	20F	103002A01F200	1300060549	103000A01F200	1300060241	103001A01F200	1300060436
4P	3F	104002A01F030	1300060991	104000A01F030	1300060725	104001A01F030	1300060898
	6F	104002A01F060	1300060995	104000A01F060	1300060728	104001A01F060	1300060902
	12F	104002A01F120	1300061002	104000A01F120	1300060737	104001A01F120	1300060905
	20F	104002A01F200	1300061009	104000A01F200	1300060744	104001A01F200	1300060912
5P	3F	105002A01F030	1300061435	105000A01F030	1300061160	105001A01F030	1300061346
	6F	105002A01F060	1300061438	105000A01F060	1300061163	105001A01F060	1300061349
	12F	105002A01F120	1300061447	105000A01F120	1300061171	105001A01F120	1300061353
	20F	105002A01F200	1300061453	105000A01F200	1300061179	105001A01F200	1300061360

Brad Mini-Change (7/8") Double-Ended Patchcords

Internal thread couplers used on both male and female cord sets

Double-Ended Mini-Change PVC Cable			
Poles	Length	Female Straight to Male Straight	
		Engineering No.	Standard Order No.
3P	3F	113020A01F030	1300100214
	6F	113020A01F060	1300100221
	12F	113020A01F120	1300100228
	20F	113020A01F200	1300100238
4P	3F	114020A01F030	1300100519
	6F	114020A01F060	1300100525
	12F	114020A01F120	1300100533
	20F	114020A01F200	1300100541
5P	3F	115020A01F030	1300100999
	6F	115020A01F060	1300101005
	12F	115020A01F120	1300101013
	20F	115020A01F200	1300101020

A01 PVC Cable Specification

Conductors:
 3 x 16 AWG (1.5mm²)
 4 x 16 AWG (1.5mm²)
 5 x 16 AWG (1.5mm²)
 Jacket Material: PVC
 Jacket Color: Yellow
 Voltage Rating: 600 VAC/VDC
 Max. Current:
 3 Conductor: 13A
 4 Conductor: 10A
 5 Conductor: 8A
 Temperature Range: -20°C to 105°C (-4°F to 221°F)
 Cable O.D:
 3 Conductor: ø 0.407" (10.33mm)
 4 Conductor: ø 0.420" (10.66mm)
 5 Conductor: ø 0.495" (12.57mm)
 Minimum Bend Radius: 10x cable diameter
 Approvals: UL Listed

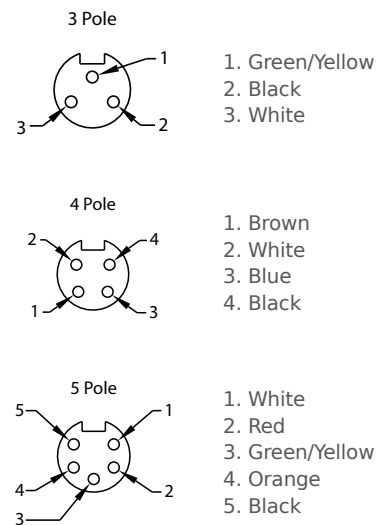

Raw Cable Ordering Information (250 FT)

A01-3 Yellow PVC: 1302090043
 A01-4 Yellow PVC: 1302100017
 A01-5 Yellow PVC: 1302110049

Brad Mini-Change (7/8") Connectivity for General, Industrial Applications

molex



Brad Mini-Change (7/8") Receptacles*

Both male and female receptacles have external mating threads

12" PVC Leads				
Poles	Male		Female	
	Engineering No.	Standard Order No.	Engineering No.	Standard Order No.
3P	1R3006A20A120	1300130202	1R3004A20A120	1300130135
4P	1R4006A20A120	1300130353	1R4004A20A120	1300130314
5P	1R5006A20A120	1300130493	1R5004A20A120	1300130442

* Gasket and Locknut Sold Separately.
 Gasket: 130180-0059
 1/2" NPT Locknut: 130184-0031

Brad Mini-Change (7/8") Field Wireables

Internal thread couplers used on both male and female field wireables



Screw Termination				
Poles	Male		Female	
	Engineering No.	Standard Order No.	Engineering No.	Standard Order No.
3P	1A3002-34	1300170008	1A3000-34	1300170004
4P	1A4002-34	1300170018	1A4000-34	1300170015
5P	1A5002-34	1300170026	1A5000-34	1300170023

Brad Mini-Change (7/8") Accessories

Mini-Change Caps		
Description	Engineering No.	Standard Order No.
Int. Thread	65-0086	1302011111
Ext. Thread	65-0085	1302011109

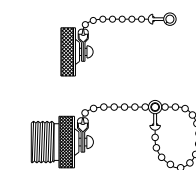

Brad Micro-Change M12 A-Code Auxiliary Power Infrastructure Components molex

Plug & Play 5 Pole power distribution infrastructure to interconnect IP67 devices based on the A-Code M12 standard connectors.



Brad Micro-Change M12 Single-Ended Cordsets



A09 PVC Cable									
		Female Straight		Female 90°		Male Straight		Male 90°	
Poles	Length	Engineering No.	Standard Order No.	Engineering No.	Standard Order No.	Engineering No.	Standard Order No.	Engineering No.	Standard Order No.
5	2m	805000A09M020	1200650471	805001A09M020	1200651697	805006A09M020	1200650523	805007A09M020	1200651724
	5m	805000A09M050	1200650479	805001A09M050	1200651701	805006A09M050	1200650528	805007A09M050	1200651727
	10m	805000A09M100	1200650487	805001A09M100	1200651706	805006A09M100	1200650533	805007A09M100	1200652123

Brad Micro-Change M12 Double-Ended Cordsets



Double-Ended Cordsets									
		Female Straight/Male Straight		Female 90°/Male Straight		Female Straight/Male 90°		Female 90°/Male 90°	
Poles	Length	Engineering No.	Standard Order No.	Engineering No.	Standard Order No.	Engineering No.	Standard Order No.	Engineering No.	Standard Order No.
5	2m	885030A09M020	1200660429	885031A09M020	1200661391	885032A09M020	1200661400	885033A09M020	1200661416
	5m	885030A09M050	1200660434	885031A09M050	1200661394	885032A09M050	1200661403	885033A09M050	1200660460
	10m	885030A09M100	1200660440	885031A09M100	1200661396	885032A09M100	1200661408	885033A09M100	1200668733

Brad Micro-Change M12 Auxiliary Power 5 Pole Receptacles



12" PVC Wire Leads					
		Male		Female	
Poles		Engineering No.	Standard Order No.	Engineering No.	Standard Order No.
5		8R5A06A18A120	1200660429	8R5A00A18A120	1200700201
		8R5006A18A120	1200660434	8R5000A18A120	1200705206

Get more insights at: www.molex.com/industry/industrial.html

molex
one company > a world of innovation