

PLUG P/N	CKT	DIM "A"	DIM "B"
1727621002	2	5.40	4.95
1727621004	4	9.60	4.95
1727621006	6	13.80	4.95
1727621008	8	18.00	4.95
1727621010	10	22.20	12.95
1727621012	12	26.40	12.95
1727621014	14	30.60	12.95
1727621016	16	34.80	12.95
1727621018	18	39.00	20.95

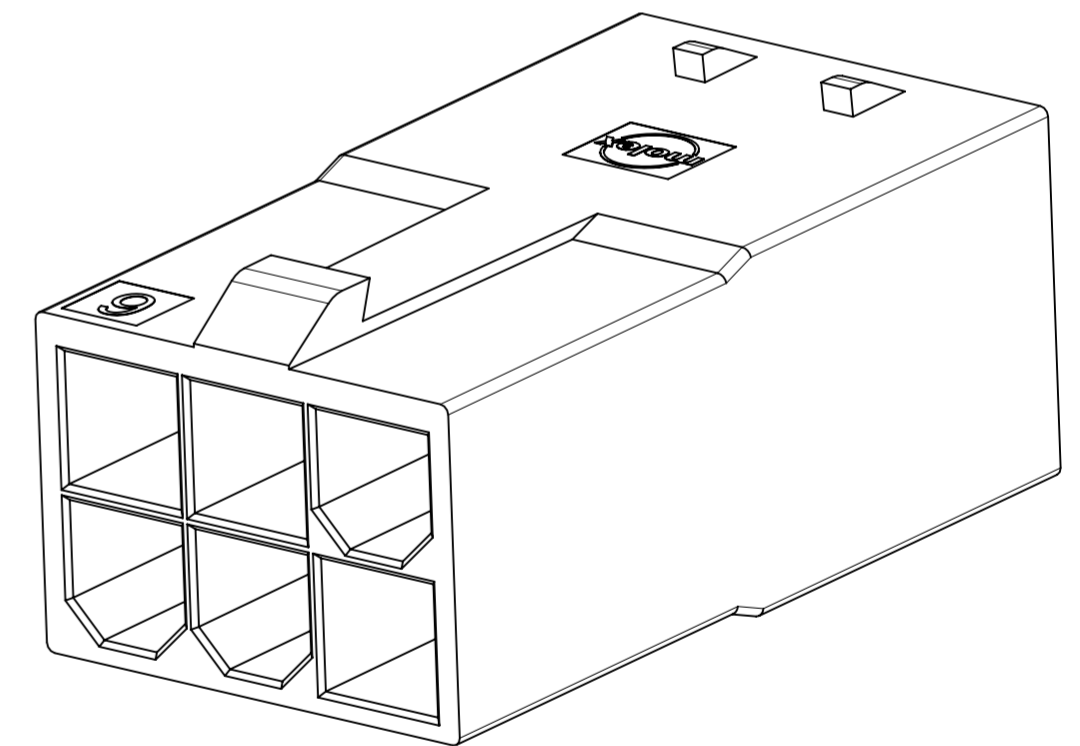
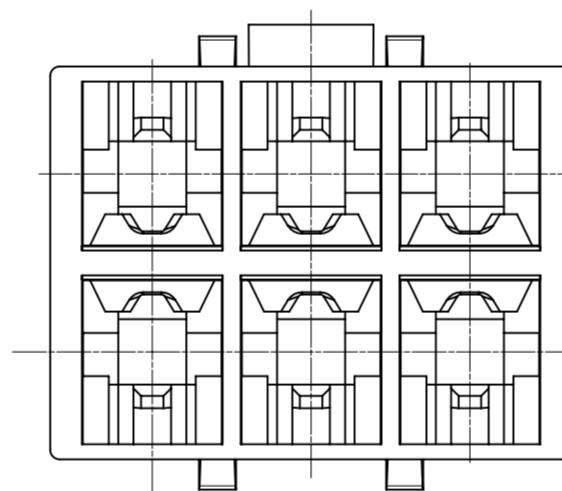
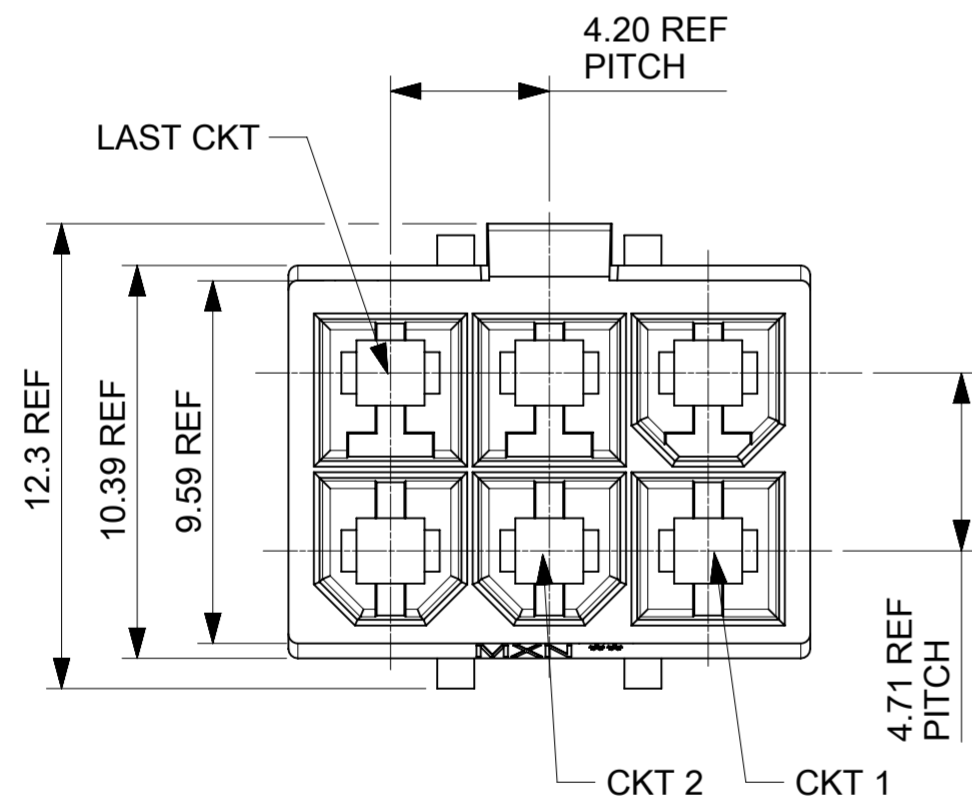

- NOTES:
- MATERIAL: NYLON, UL 94V-0 AND GLOW WIRE CAPABLE PER IEC60335-1; COLOR: BLACK
 - FINISH: NONE
 - PRODUCT SPECIFICATION: 2131370000-PS/2029880002-PS
APPLICATION SPECIFICATION: 2131370000-AS
 - PACKAGING SPECIFICATION: 1727620001-PK
REFER TO AS-45499-001 FOR MOISTURIZING NYLON CONNECTOR PARTS.
 - THIS PART TO BE USED WITH FEMALE TERMINAL SERIES 172765, 203070 AND TPA SERIES 172709-2***.
 - THIS PART MATES WITH RECEPTACLE SERIES 172708-0***, 172708-1***.
 - THIS PART CONFORMS TO CLASS 'B' REQUIREMENTS OF COSMETIC SPECIFICATION PS-45499-002.

THIS DRAWING CONTAINS INFORMATION THAT IS PROPRIETARY TO MOLEX ELECTRONIC TECHNOLOGIES, LLC AND SHOULD NOT BE USED WITHOUT WRITTEN PERMISSION									
DIMENSION UNITS	SCALE	CURRENT REV DESC:				molex			
mm	NTS								
GENERAL TOLERANCES (UNLESS SPECIFIED)						SD-DRAWING OF MINI-FIT SIGMA DR PLUG			
ANGULAR TOL	± °					PRODUCT CUSTOMER DRAWING			
4 PLACES	±	EC NO: 768511		2023/11/02		DOCUMENT NUMBER: 1727620001-SD DOC TYPE: PSD DOC PART: 000 REVISION: A6			
3 PLACES	±	DRWN: JERRYW8		2023/11/15					
2 PLACES	± 0.25	CHK'D: XQZHANG		2023/11/15		MATERIAL NUMBER: SEE TABLE CUSTOMER: GENERAL MARKET SHEET NUMBER: 1 OF 4			
1 PLACE	± 0.36	APPR: XQZHANG		2023/11/15					
0 PLACES	±	INITIAL REVISION:							
DRAFT WHERE APPLICABLE MUST REMAIN WITHIN DIMENSIONS		THIRD ANGLE PROJECTION		DRAWING: A2-SIZE		SERIES: 172762			

DOCUMENT STATUS	P1	RELEASE DATE	2023/11/15	09:48:29
-----------------	----	--------------	------------	----------

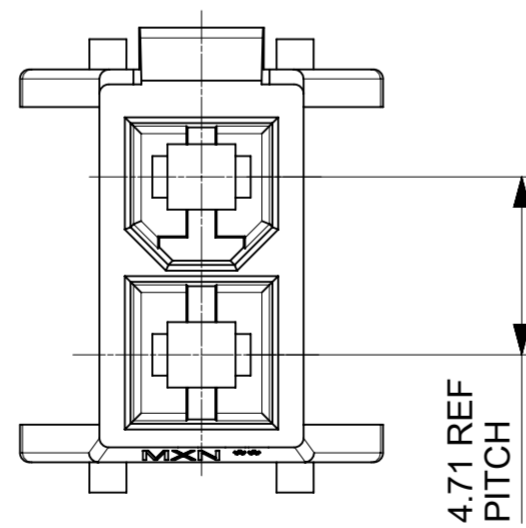
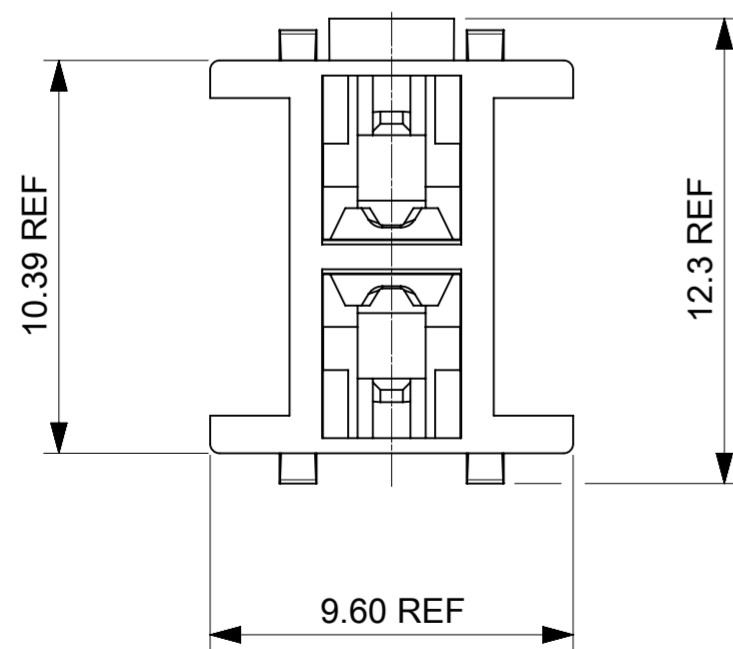
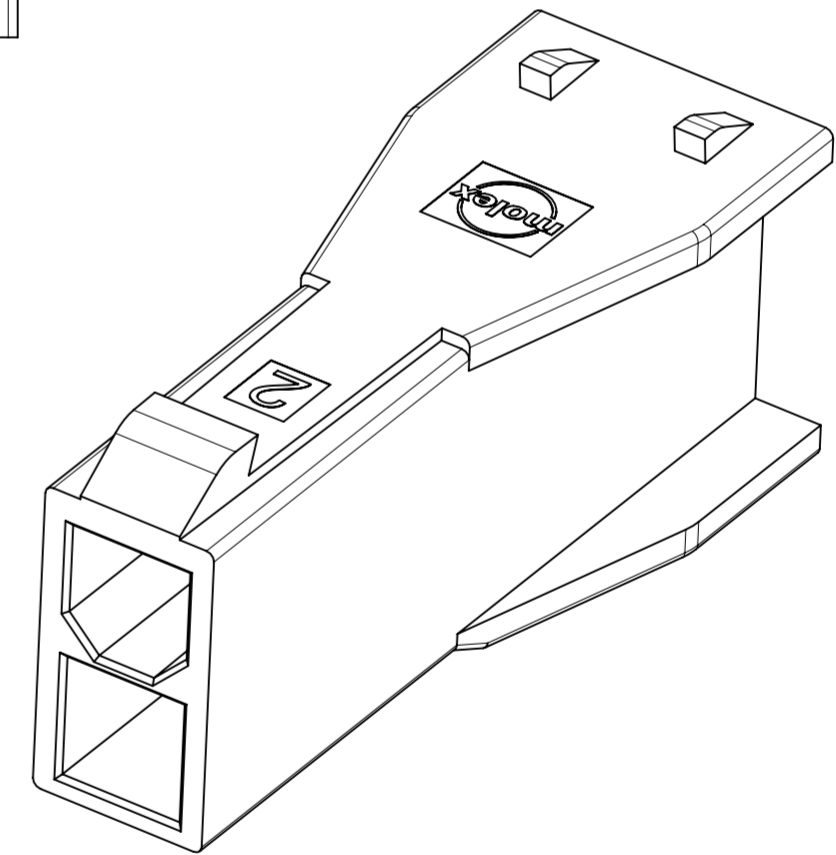
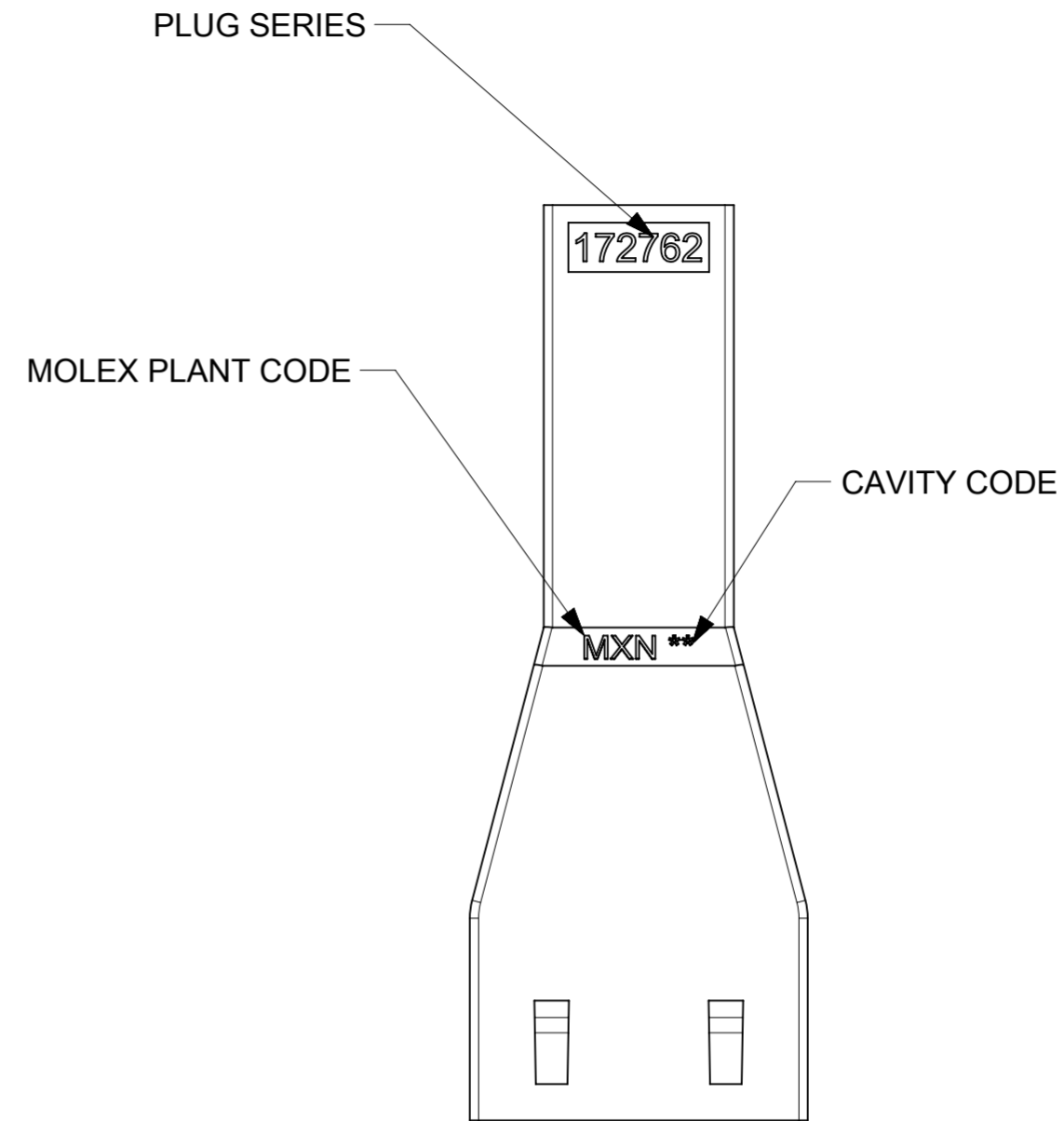
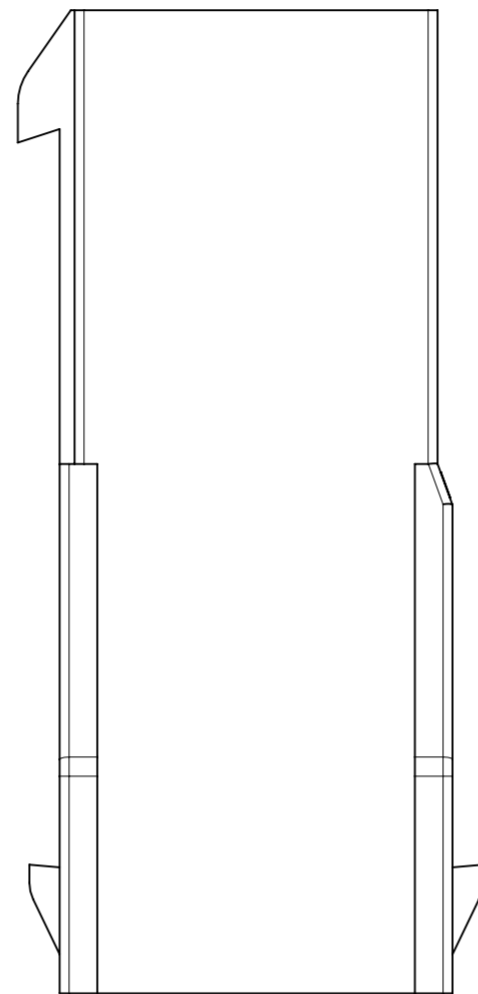
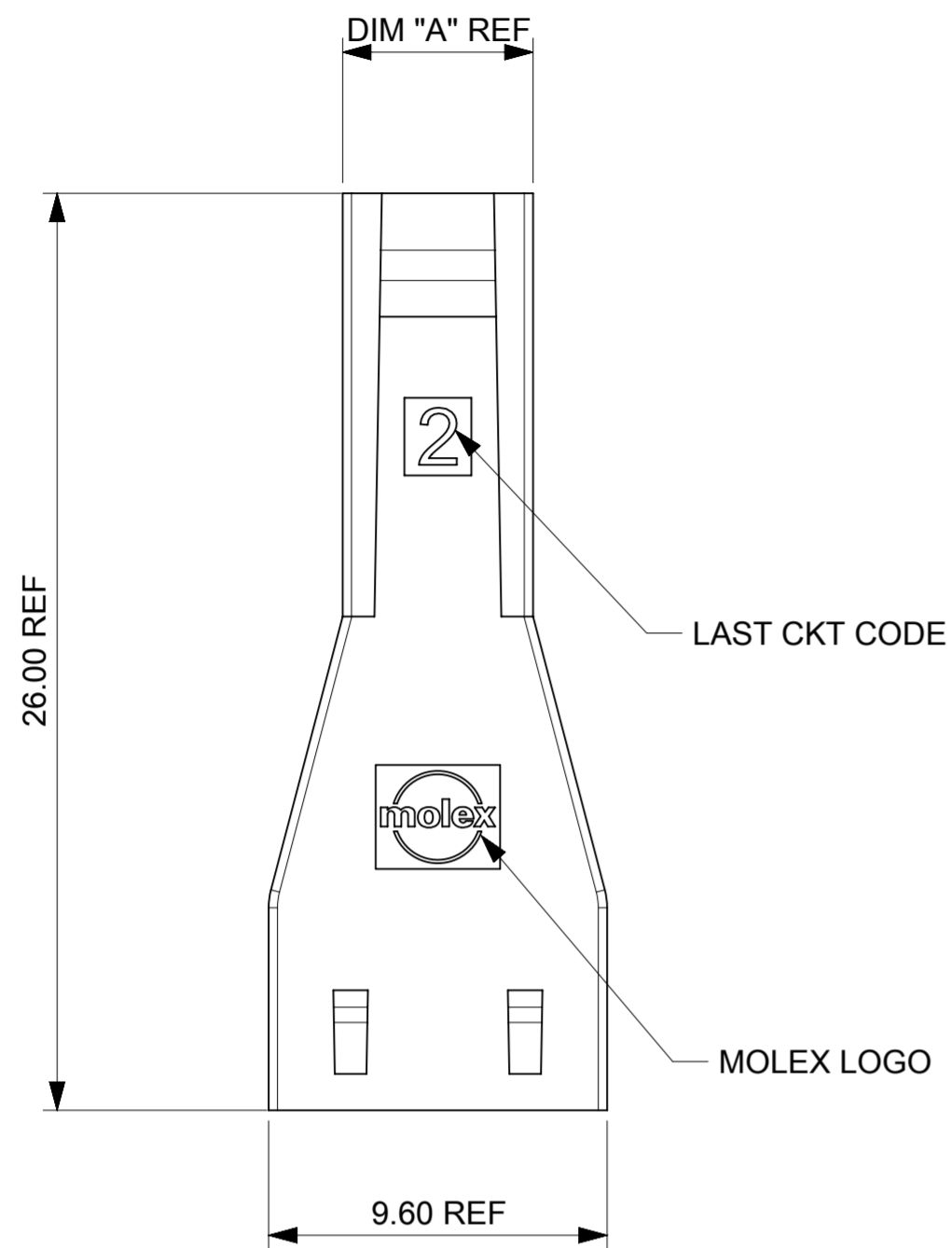

THIS DRAWING CONTAINS INFORMATION THAT IS PROPRIETARY TO MOLEX ELECTRONIC TECHNOLOGIES, LLC AND SHOULD NOT BE USED WITHOUT WRITTEN PERMISSION									
DIMENSION UNITS		SCALE		CURRENT REV DESC:				molex	
mm		NTS							
GENERAL TOLERANCES (UNLESS SPECIFIED)								SD-DRAWING OF MINI-FIT SIGMA DR PLUG	
ANGULAR TOL		± °		EC NO: 768511				PRODUCT CUSTOMER DRAWING	
4 PLACES		±		DRWN: JERRYW8		2023/11/02			
3 PLACES		±		CHK'D: XQZHANG		2023/11/15			
2 PLACES		± 0.25		APPR: XQZHANG		2023/11/15			
1 PLACE		± 0.36		INITIAL REVISION:				DOCUMENT NUMBER	
0 PLACES		±		DRWN: ALU002		2019/09/18		1727620001-SD	
				APPR: YXZHENG		2019/10/11		PSD 000 A6	
DRAFT WHERE APPLICABLE MUST REMAIN WITHIN DIMENSIONS		THIRD ANGLE PROJECTION		DRAWING		SERIES		MATERIAL NUMBER	
				A2-SIZE		172762		SEE TABLE	
				GENERAL MARKET				SHEET NUMBER	
								2 OF 4	

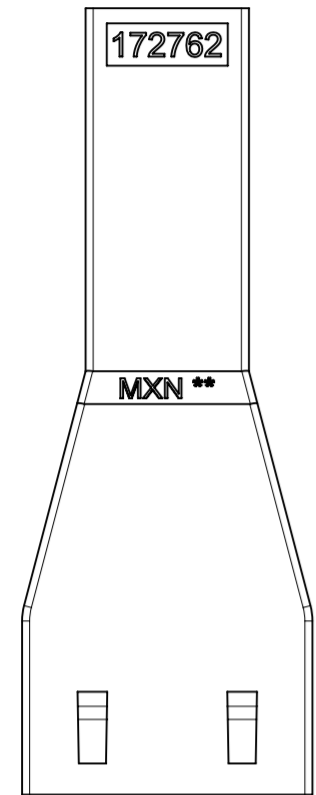
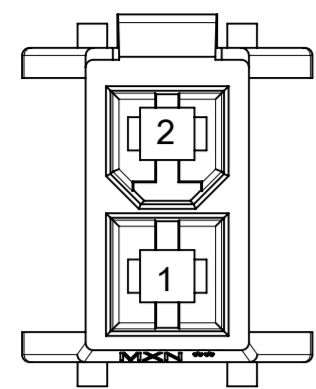

2-CKT

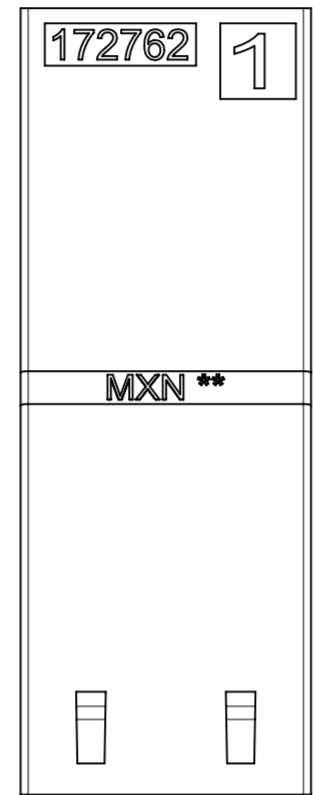
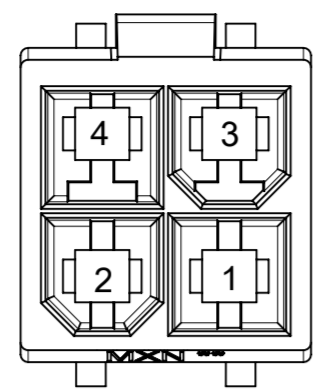

4-CKT

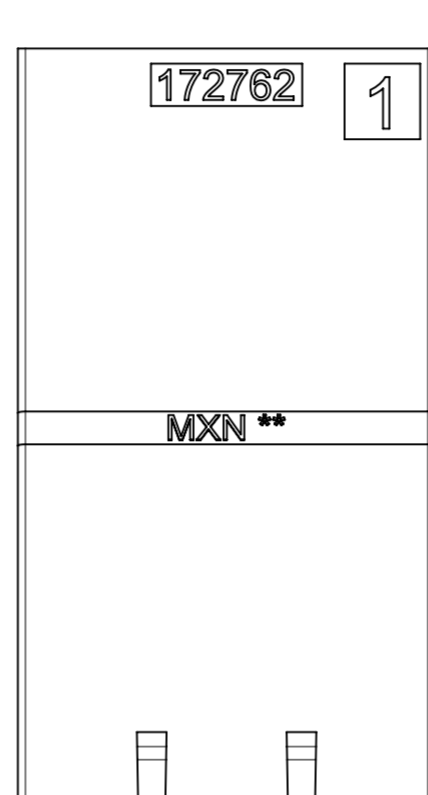
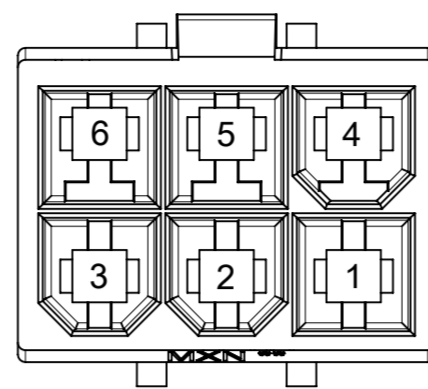

6-CKT

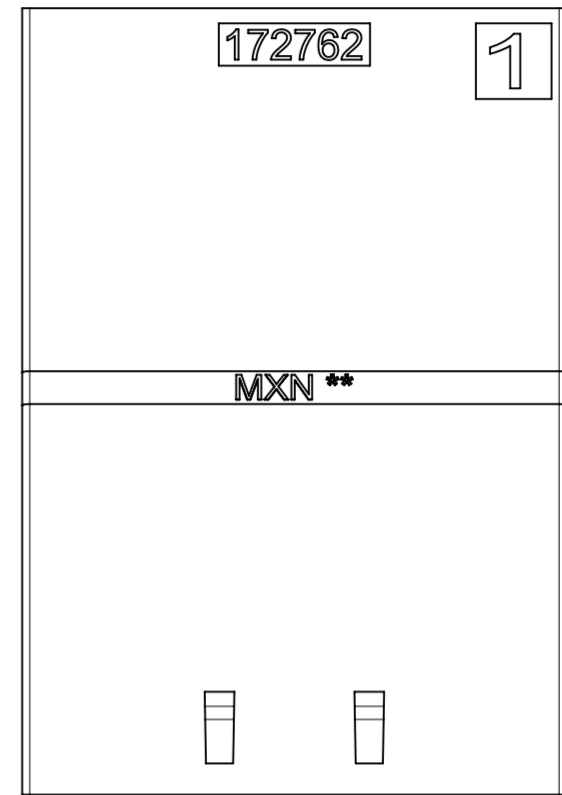
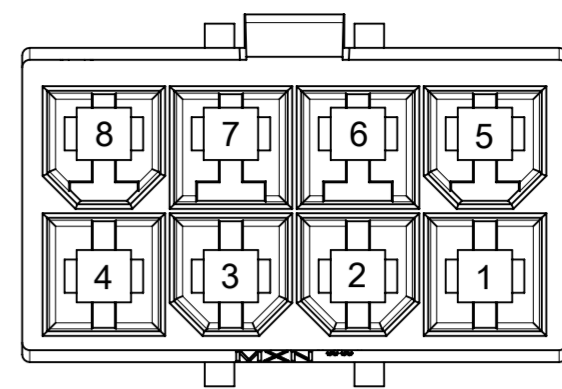

8-CKT

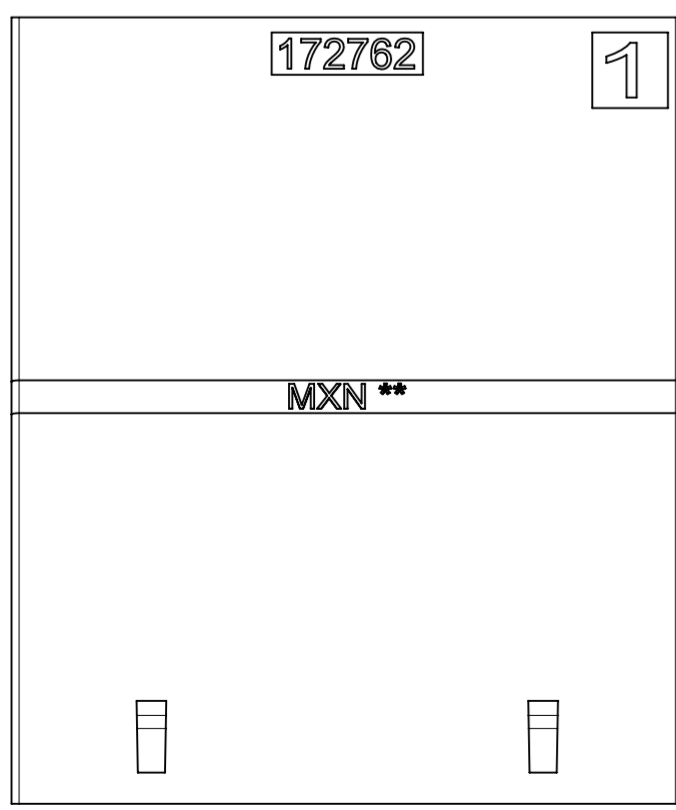
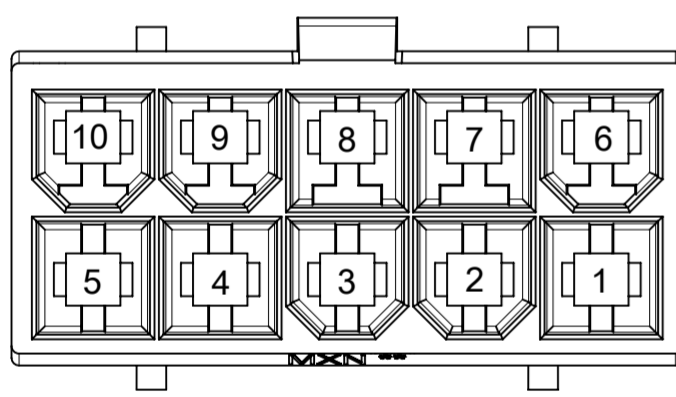

10-CKT

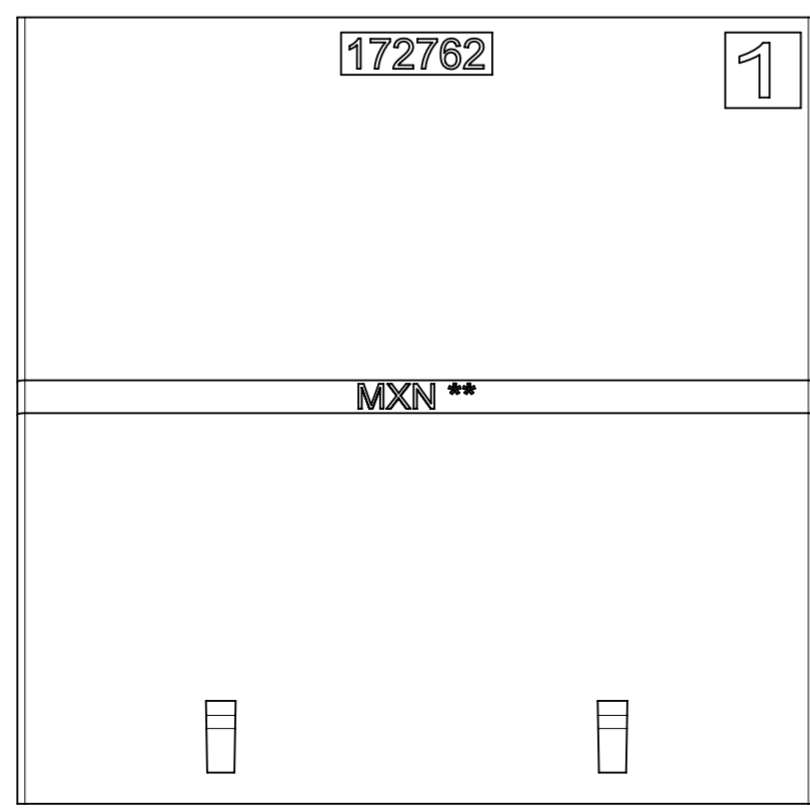
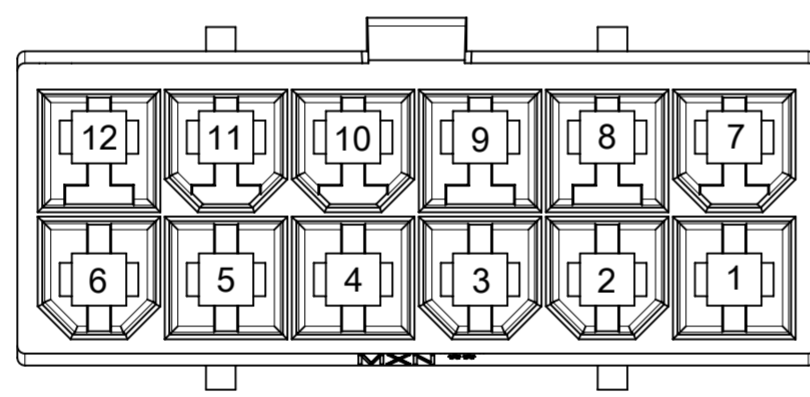

12-CKT

THIS DRAWING CONTAINS INFORMATION THAT IS PROPRIETARY TO MOLEX ELECTRONIC TECHNOLOGIES, LLC AND SHOULD NOT BE USED WITHOUT WRITTEN PERMISSION									
DIMENSION UNITS		SCALE		CURRENT REV DESC:					
mm		NTS							
GENERAL TOLERANCES (UNLESS SPECIFIED)				EC NO: 768511				SD-DRAWING OF MINI-FIT SIGMA DR PLUG	
ANGULAR TOL ± °				DRWN: JERRYW8 2023/11/02					
4 PLACES ±				CHK'D: XQZHANG 2023/11/15				PRODUCT CUSTOMER DRAWING	
3 PLACES ±				APPR: XQZHANG 2023/11/15					
2 PLACES ± 0.25				INITIAL REVISION:				DOCUMENT NUMBER	
1 PLACE ± 0.36				DRWN: ALUO02 2019/09/18					
0 PLACES ±				APPR: YXZHENG 2019/10/11				1727620001-SD	
DRAFT WHERE APPLICABLE MUST REMAIN WITHIN DIMENSIONS		THIRD ANGLE PROJECTION		DRAWING		SERIES		MATERIAL NUMBER	
				A2-SIZE		172762		SEE TABLE	
				CUSTOMER		GENERAL MARKET		SHEET NUMBER	
								3 OF 4	

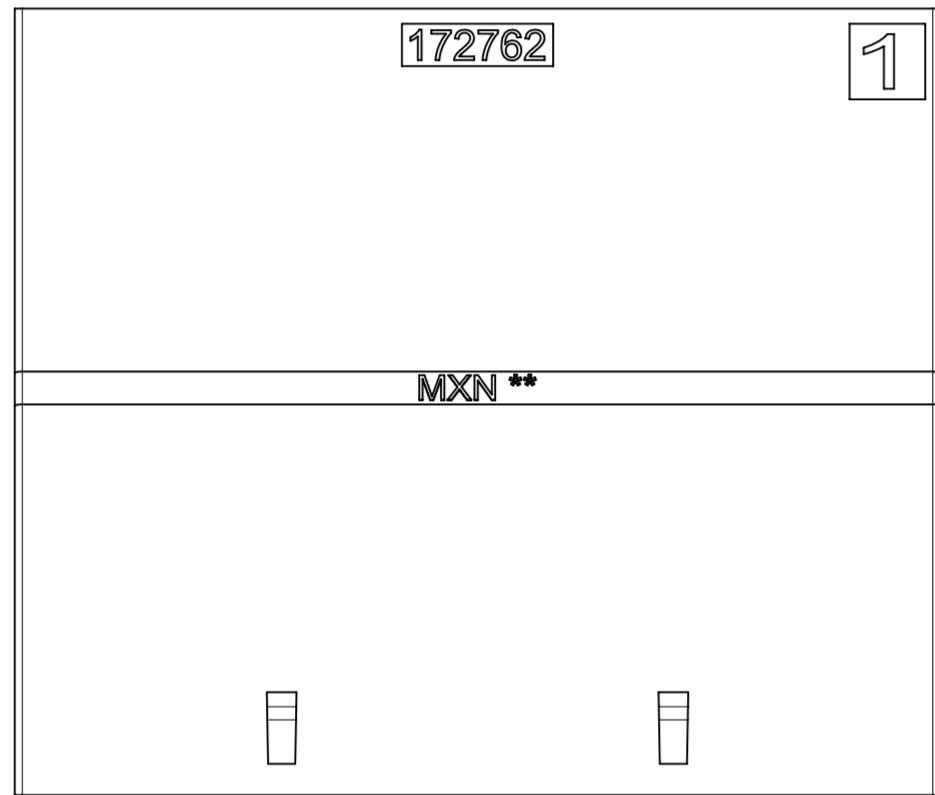
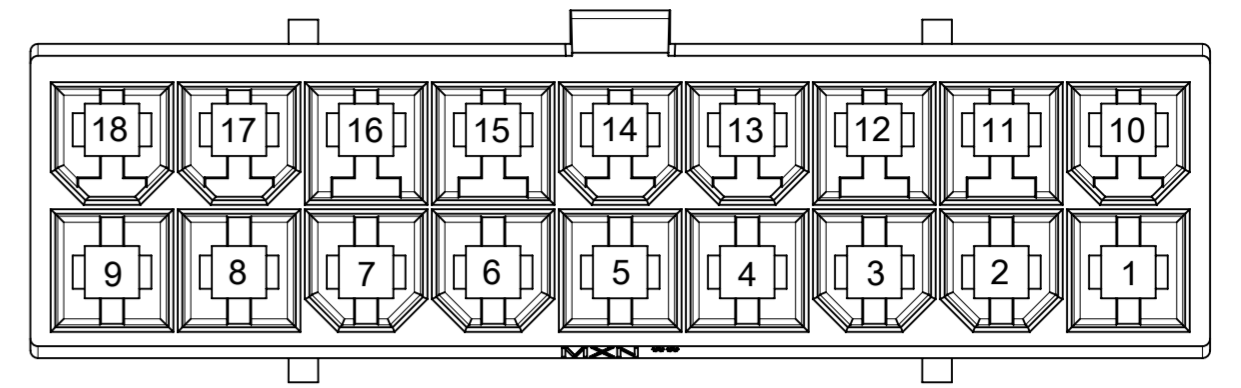
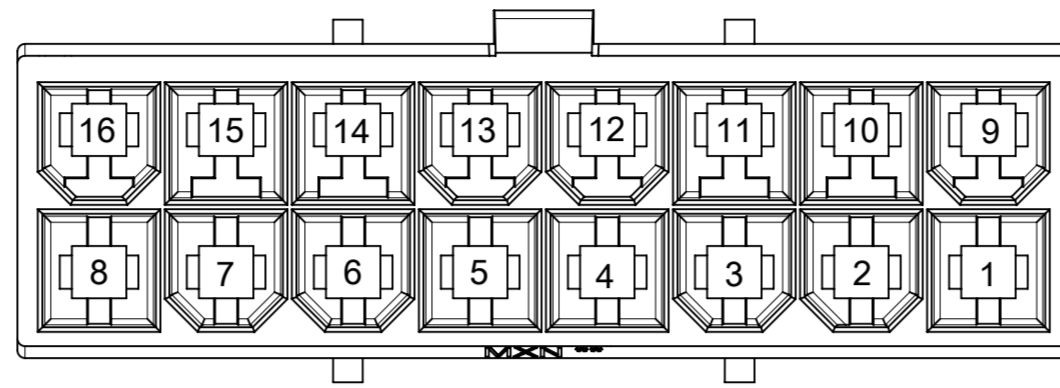
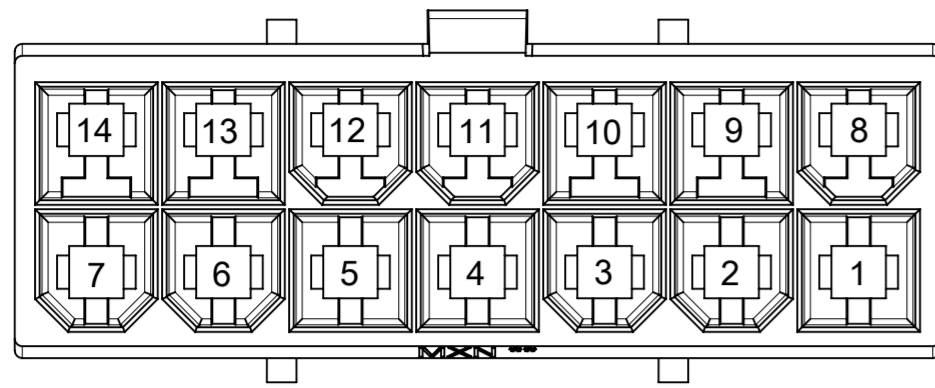

14-CKT

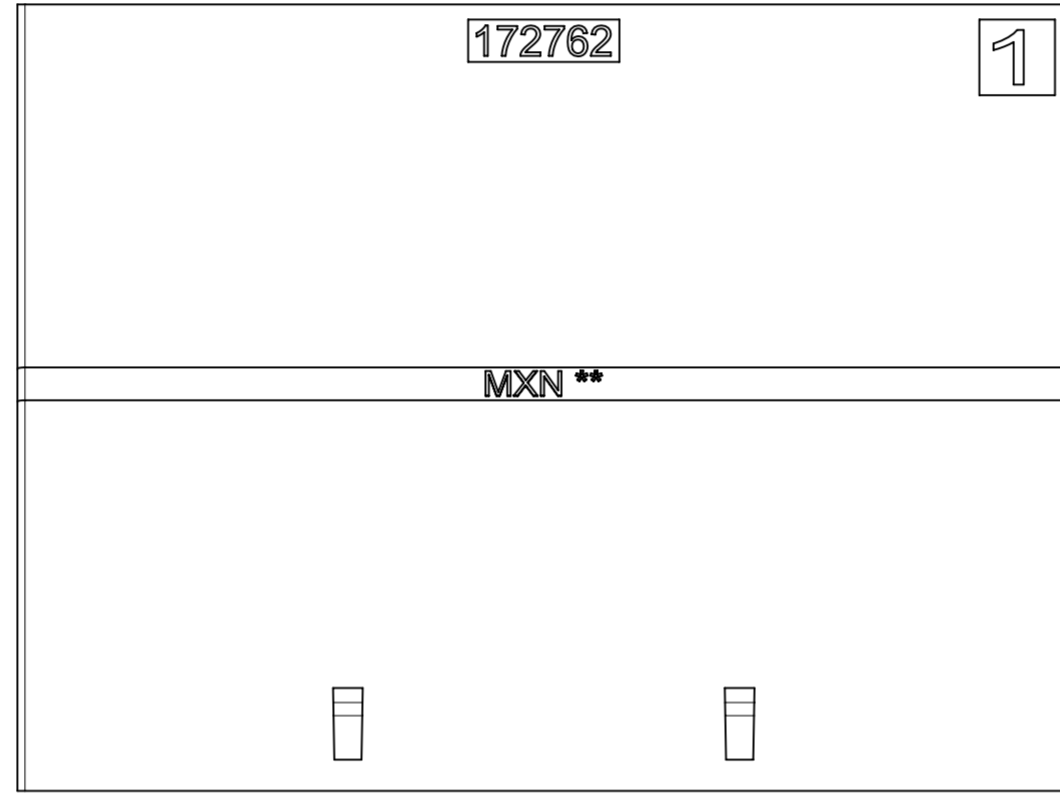

16-CKT

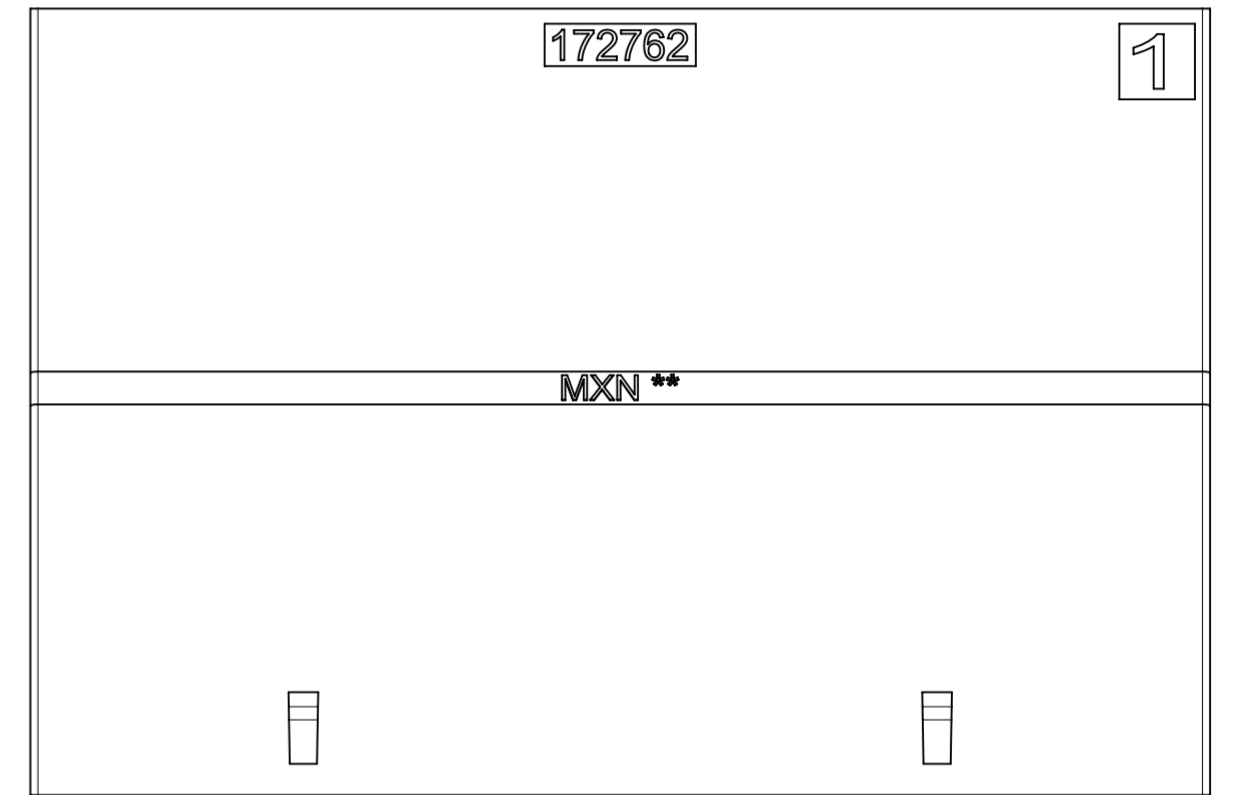

18-CKT

THIS DRAWING CONTAINS INFORMATION THAT IS PROPRIETARY TO MOLEX ELECTRONIC TECHNOLOGIES, LLC AND SHOULD NOT BE USED WITHOUT WRITTEN PERMISSION										
DIMENSION UNITS	SCALE	CURRENT REV DESC:				molex				
mm	NTS									
GENERAL TOLERANCES (UNLESS SPECIFIED)						SD-DRAWING OF MINI-FIT SIGMA DR PLUG				
ANGULAR TOL	± °					PRODUCT CUSTOMER DRAWING				
4 PLACES	±	EC NO: 768511		2023/11/02		DOCUMENT NUMBER				
3 PLACES	±	DRWN: JERRYW8		2023/11/15						
2 PLACES	± 0.25	CHK'D: XQZHANG		2023/11/15		1727620001-SD				
1 PLACE	± 0.36	APPR: XQZHANG		2023/11/15						
0 PLACES	±	INITIAL REVISION:				DOC TYPE				
DRAFT WHERE APPLICABLE MUST REMAIN WITHIN DIMENSIONS		THIRD ANGLE PROJECTION		DRAWING		SERIES		CUSTOMER		REVISION
				A2-SIZE		172762		GENERAL MARKET		A6
						SEE TABLE		4 OF 4		