

PLUG P/N	CKT	DIM "A"	DIM "B"
1727621002	2	5.40	4.95
1727621004	4	9.60	4.95
1727621006	6	13.80	4.95
1727621008	8	18.00	4.95
1727621010	10	22.20	12.95
1727621012	12	26.40	12.95
1727621014	14	30.60	12.95
1727621016	16	34.80	12.95
1727621018	18	39.00	20.95

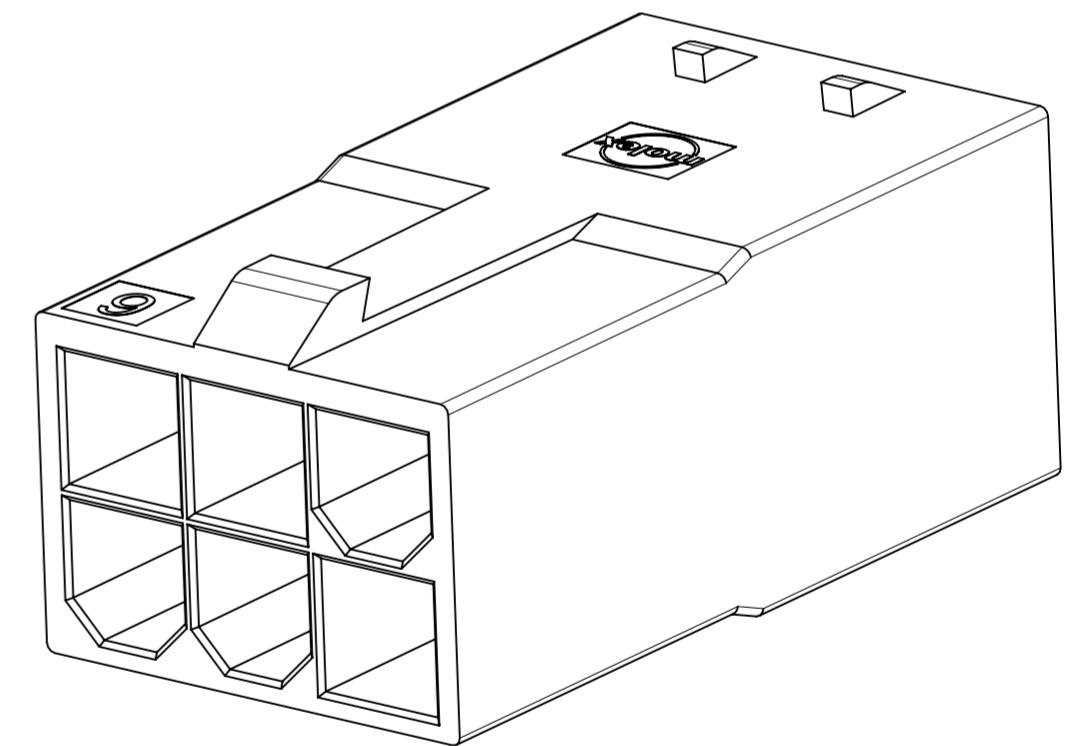
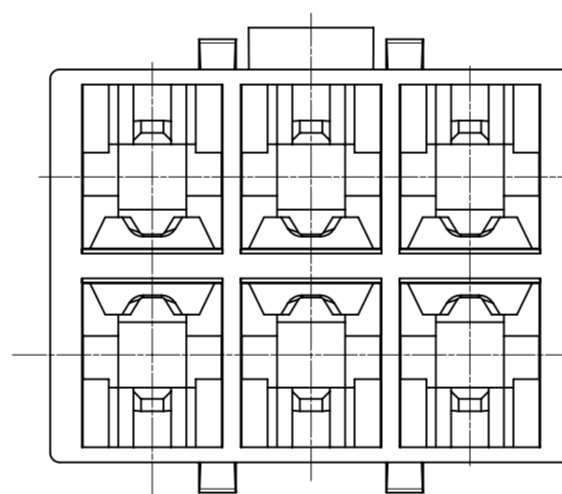
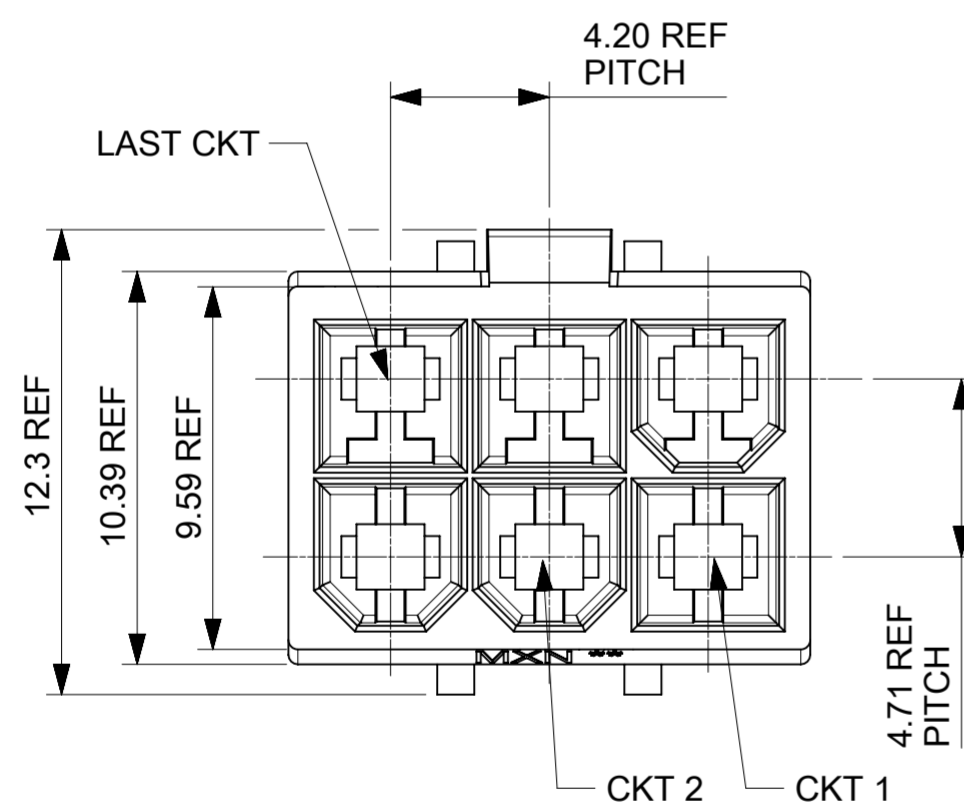

- NOTES:
1. MATERIAL: NYLON, UL 94V-0 AND GLOW WIRE CAPABLE PER IEC60335-1; COLOR: BLACK
 2. FINISH: NONE
 3. PRODUCT SPECIFICATION: 2131370000-PS/2029880002-PS
APPLICATION SPECIFICATION: 2131370000-AS
 4. PACKAGING SPECIFICATION: 1727620001-PK
REFER TO AS-45499-001 FOR MOISTURIZING NYLON CONNECTOR PARTS.
 5. THIS PART TO BE USED WITH FEMALE TERMINAL SERIES 172765, 203070 AND TPA SERIES 172709-2***.
 6. THIS PART MATES WITH RECEPTACLE SERIES 172708-0***, 172708-1***.
 7. THIS PART CONFORMS TO CLASS 'B' REQUIREMENTS OF COSMETIC SPECIFICATION PS-45499-002.

THIS DRAWING CONTAINS INFORMATION THAT IS PROPRIETARY TO MOLEX ELECTRONIC TECHNOLOGIES, LLC AND SHOULD NOT BE USED WITHOUT WRITTEN PERMISSION									
DIMENSION UNITS	SCALE	CURRENT REV DESC:				molex			
mm	NTS					SD-DRAWING OF MINI-FIT SIGMA DR PLUG			
GENERAL TOLERANCES (UNLESS SPECIFIED)									
ANGULAR TOL	± °	EC NO: 768511				DOCUMENT NUMBER			
4 PLACES	±	DRWN: JERRYW8 2023/11/02				1727620001-SD			
3 PLACES	±	CHK'D: XQZHANG 2023/11/15				DOC TYPE DOC PART REVISION			
2 PLACES	± 0.25	APPR: XQZHANG 2023/11/15				PSD 000 A6			
1 PLACE	± 0.36	INITIAL REVISION:				MATERIAL NUMBER			
0 PLACES	±	DRWN: ALUO02 2019/09/18				CUSTOMER			
DRAFT WHERE APPLICABLE MUST REMAIN WITHIN DIMENSIONS		THIRD ANGLE PROJECTION		DRAWING	SERIES	SHEET NUMBER			
		A2-SIZE		172762	SEE TABLE		GENERAL MARKET		1 OF 4

DOCUMENT STATUS	P1	RELEASE DATE	2023/11/15	09:48:29
-----------------	----	--------------	------------	----------

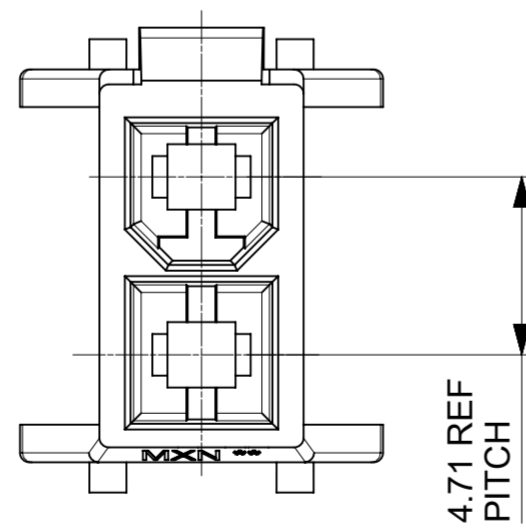
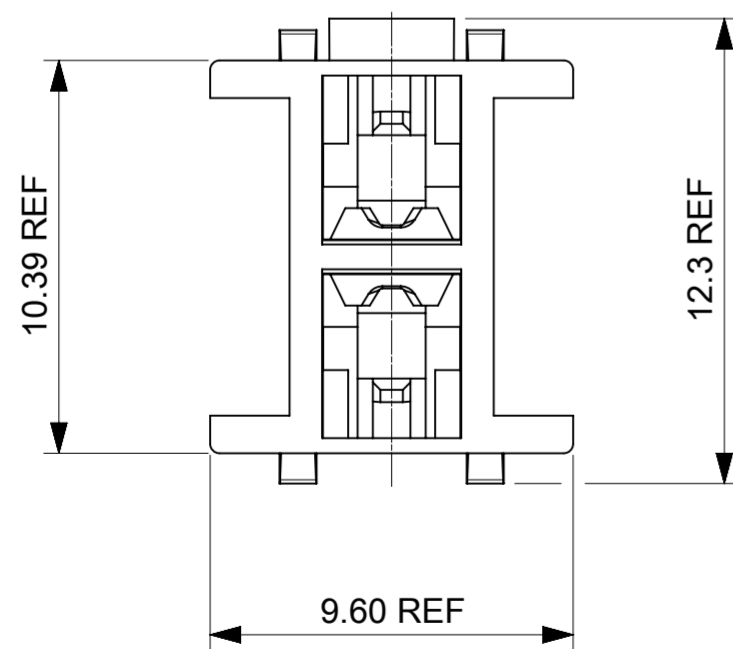
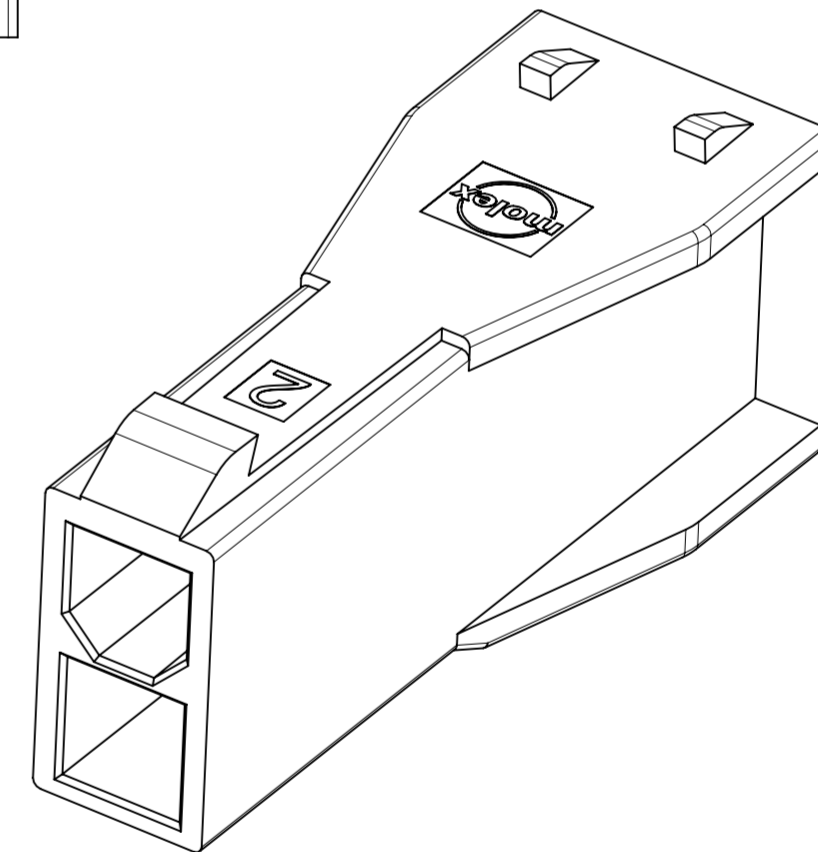
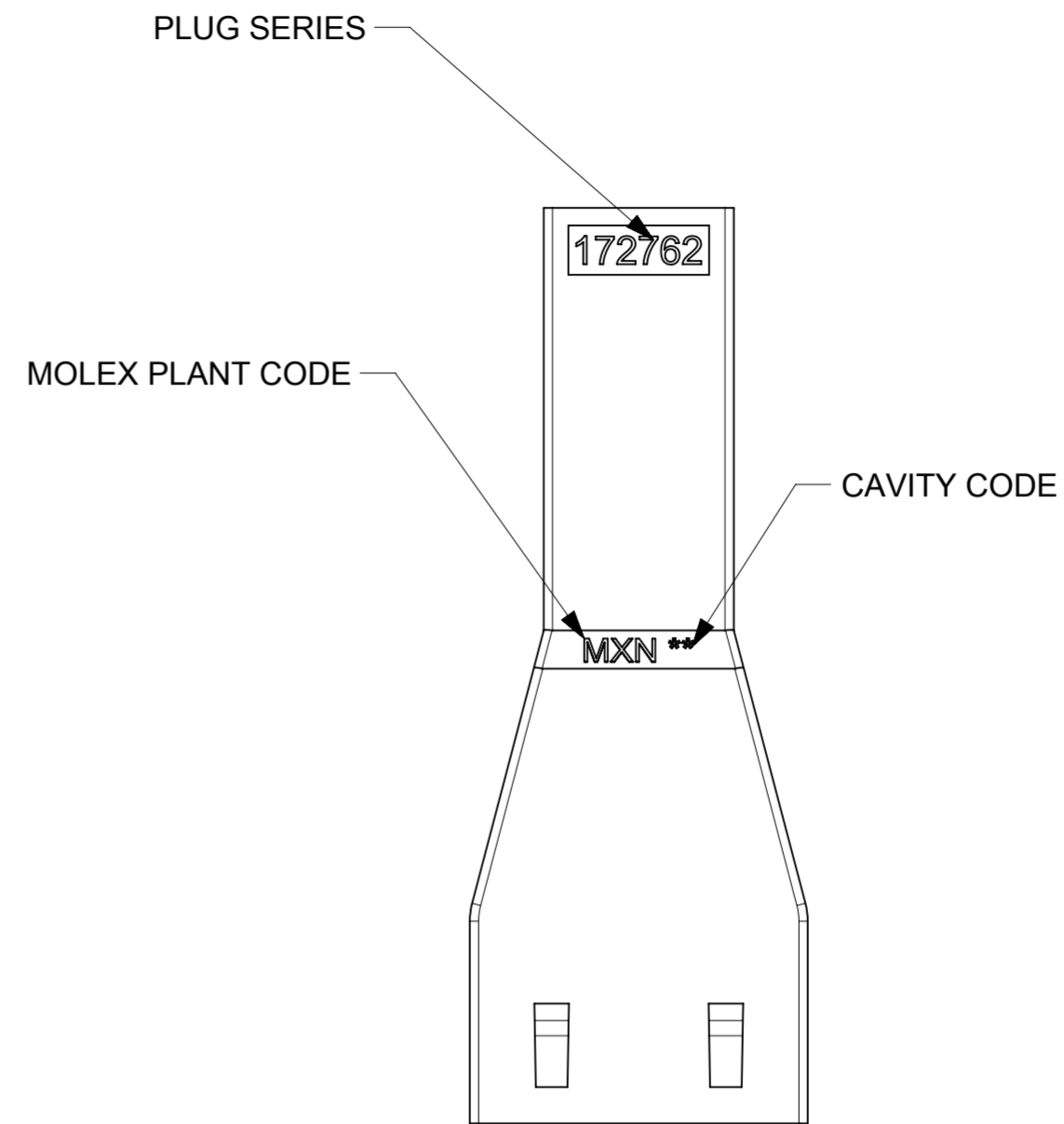
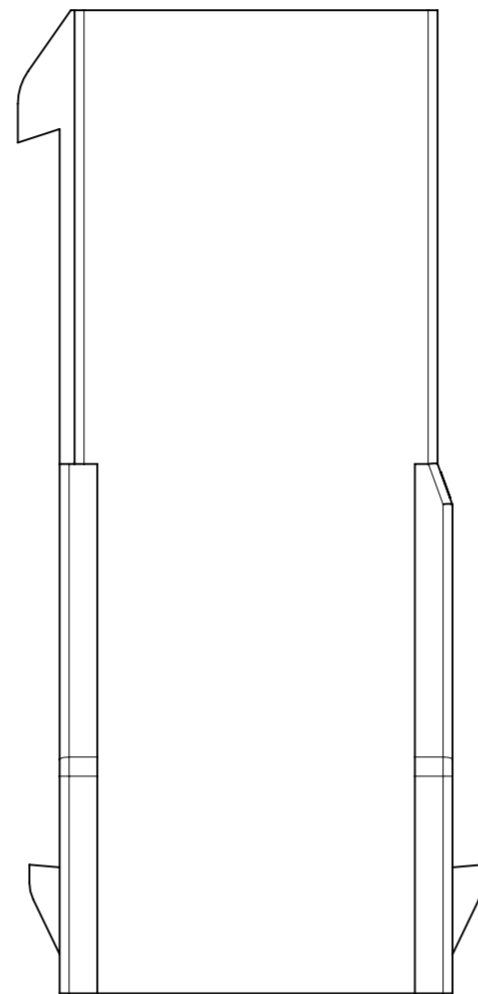
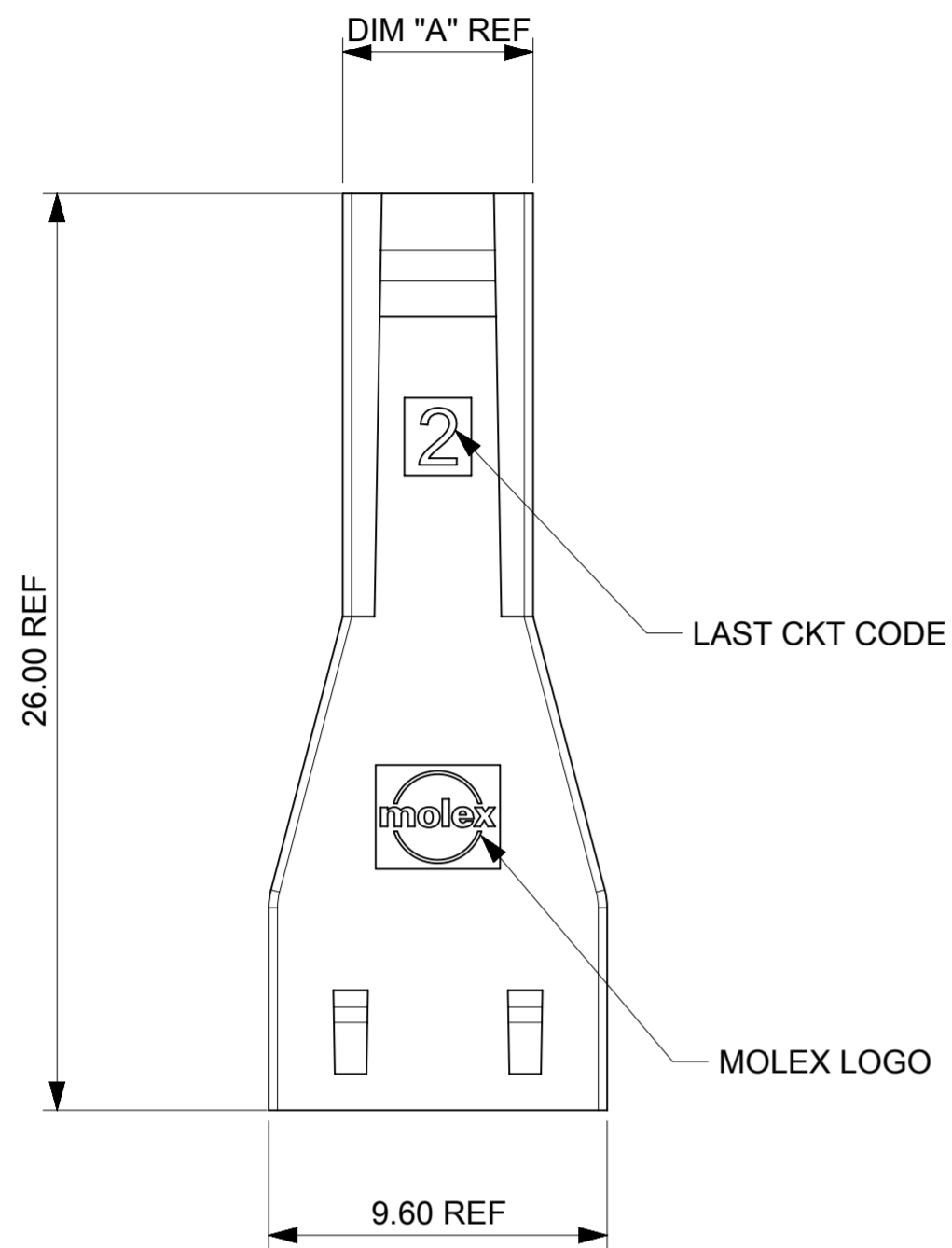

THIS DRAWING CONTAINS INFORMATION THAT IS PROPRIETARY TO MOLEX ELECTRONIC TECHNOLOGIES, LLC AND SHOULD NOT BE USED WITHOUT WRITTEN PERMISSION										
DIMENSION UNITS		SCALE		CURRENT REV DESC:				molex		
mm		NTS								
GENERAL TOLERANCES (UNLESS SPECIFIED)								SD-DRAWING OF MINI-FIT SIGMA DR PLUG		
ANGULAR TOL		± °		EC NO: 768511				PRODUCT CUSTOMER DRAWING		
4 PLACES		±		DRWN: JERRYW8		2023/11/02				
3 PLACES		±		CHK'D: XQZHANG		2023/11/15				
2 PLACES		± 0.25		APPR: XQZHANG		2023/11/15				
1 PLACE		± 0.36		INITIAL REVISION:				DOCUMENT NUMBER		
0 PLACES		±		DRWN: ALUO02		2019/09/18		1727620001-SD		
				APPR: YXZHENG		2019/10/11		DOC TYPE	DOC PART	REVISION
DRAFT WHERE APPLICABLE MUST REMAIN WITHIN DIMENSIONS		THIRD ANGLE PROJECTION		DRAWING	SERIES	MATERIAL NUMBER	CUSTOMER		SHEET NUMBER	
				A2-SIZE	172762	SEE TABLE	GENERAL MARKET		2 OF 4	

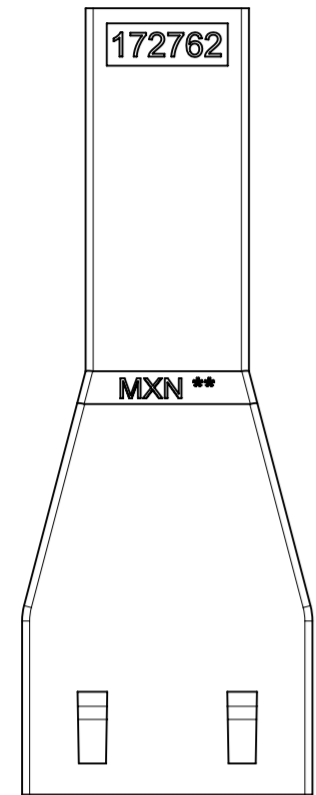
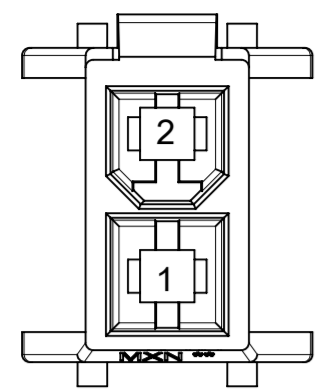

2-CKT

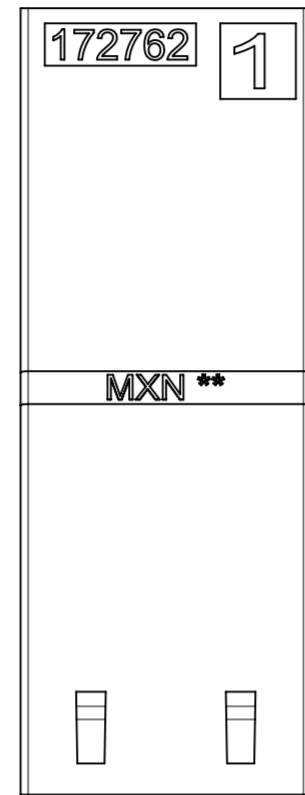
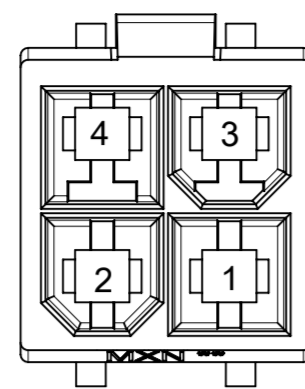

4-CKT

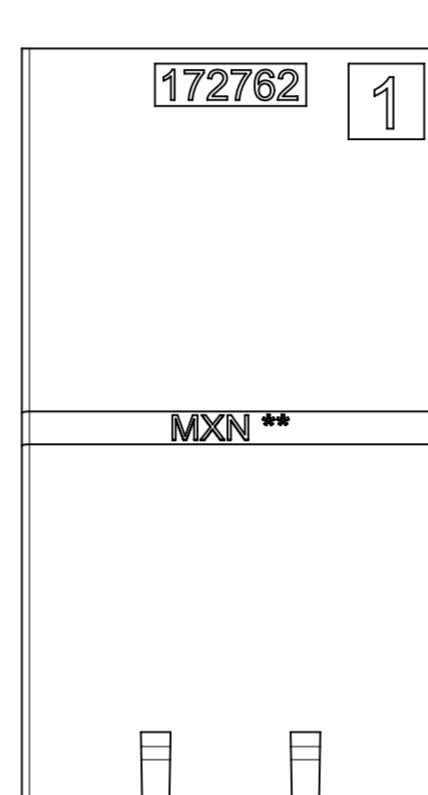
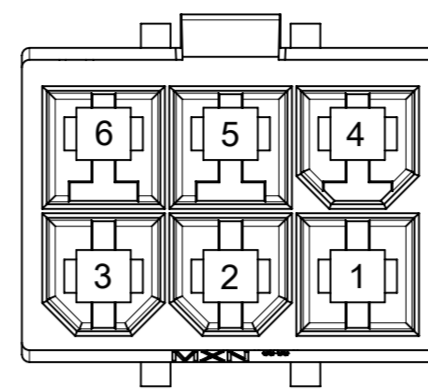

6-CKT

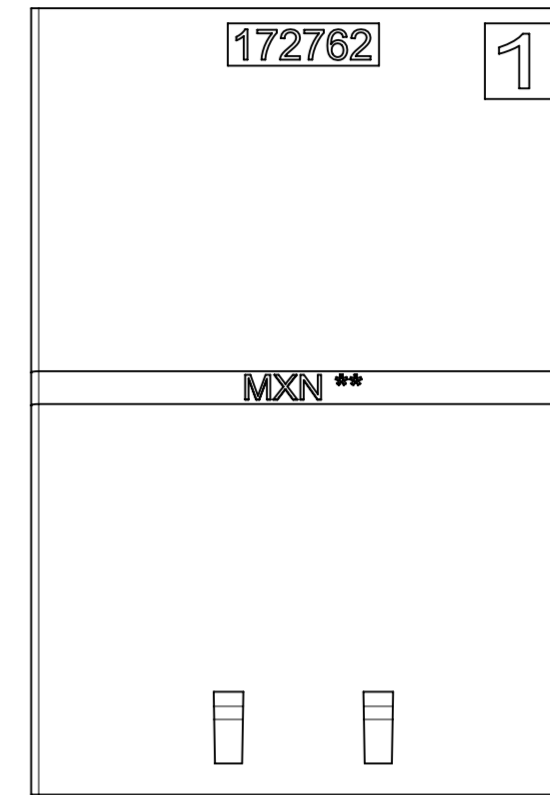
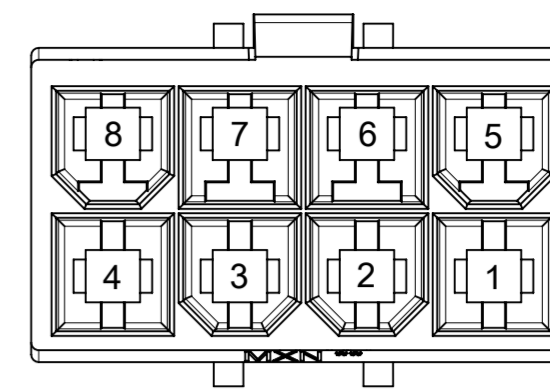

8-CKT

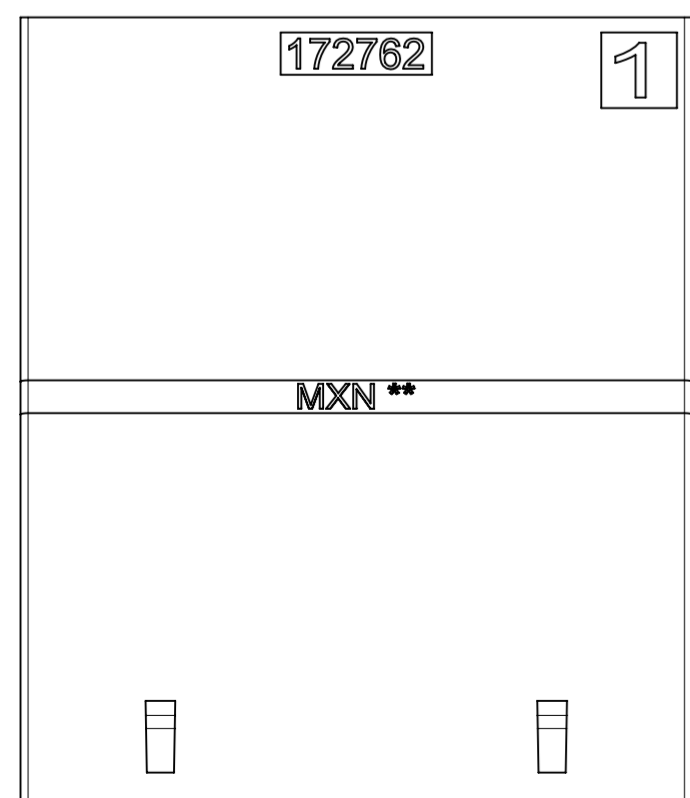
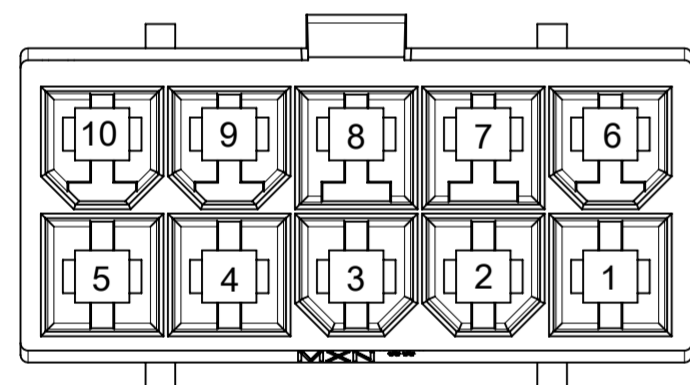

10-CKT

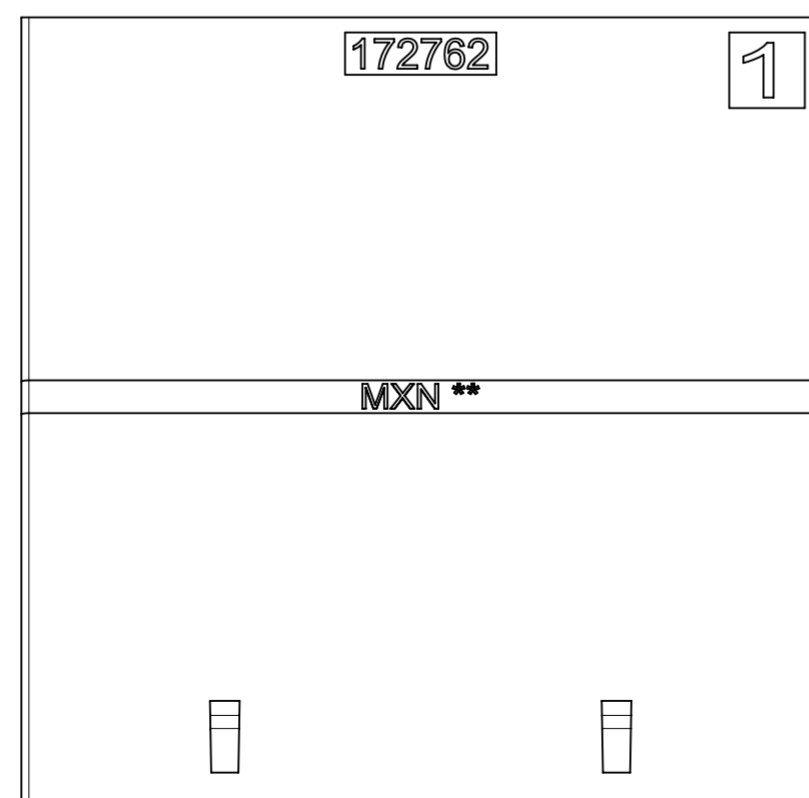
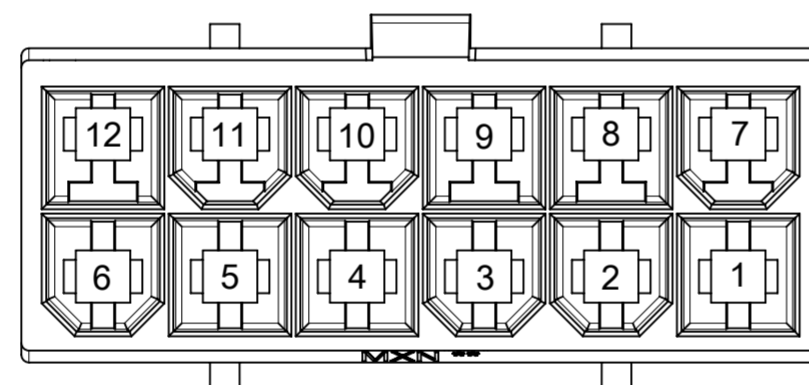

12-CKT

THIS DRAWING CONTAINS INFORMATION THAT IS PROPRIETARY TO MOLEX ELECTRONIC TECHNOLOGIES, LLC AND SHOULD NOT BE USED WITHOUT WRITTEN PERMISSION									
DIMENSION UNITS	SCALE	CURRENT REV DESC:							
mm	NTS								
GENERAL TOLERANCES (UNLESS SPECIFIED)					SD-DRAWING OF MINI-FIT SIGMA DR PLUG				
ANGULAR TOL	±	°							
4 PLACES	±	EC NO: 768511			PRODUCT CUSTOMER DRAWING				
3 PLACES	±	DRWN: JERRYW8 2023/11/02							
2 PLACES	±	CHK'D: XQZHANG 2023/11/15			DOCUMENT NUMBER: 1727620001-SD DOC TYPE: PSD DOC PART: 000 REVISION: A6				
1 PLACE	±	APPR: XQZHANG 2023/11/15							
0 PLACES	±	INITIAL REVISION:			MATERIAL NUMBER: SEE TABLE CUSTOMER: GENERAL MARKET SHEET NUMBER: 3 OF 4				
		DRWN: ALUO02 2019/09/18							
		APPR: YXZHENG 2019/10/11							
DRAFT WHERE APPLICABLE MUST REMAIN WITHIN DIMENSIONS		THIRD ANGLE PROJECTION		DRAWING	SERIES	MATERIAL NUMBER	CUSTOMER	SHEET NUMBER	
				A2-SIZE	172762	SEE TABLE	GENERAL MARKET	3 OF 4	

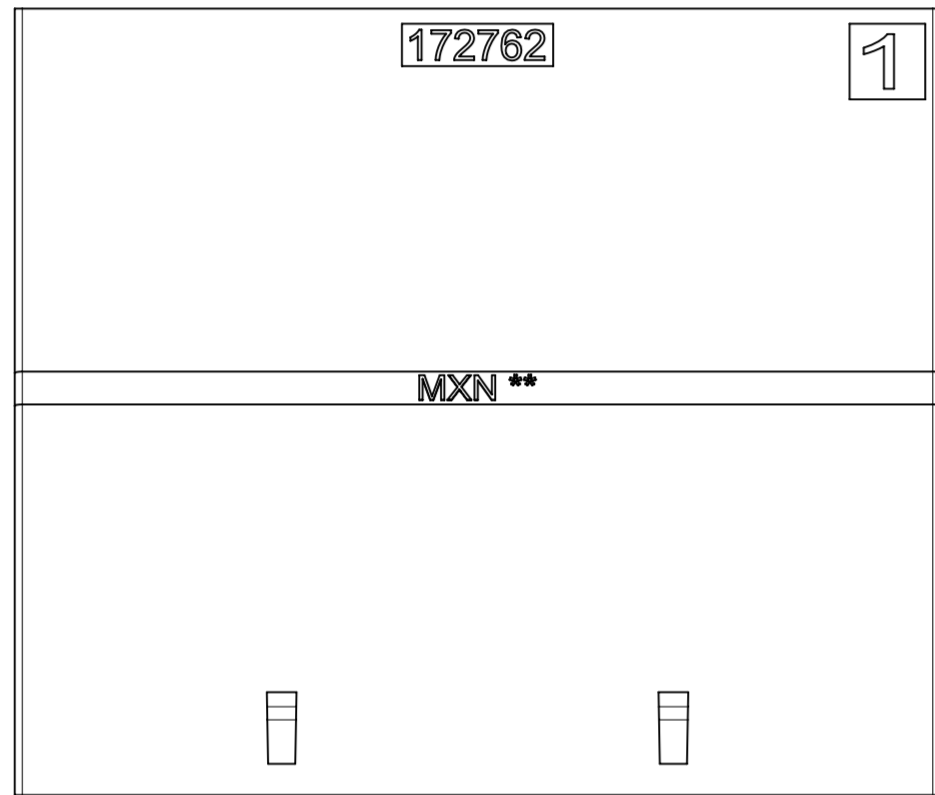
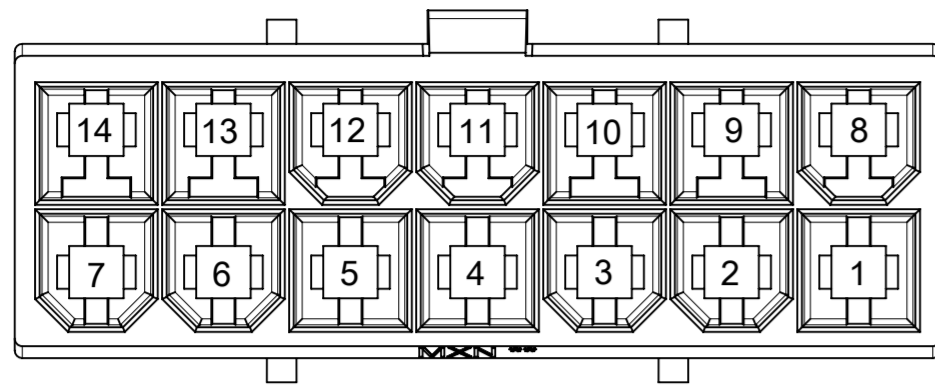

14-CKT

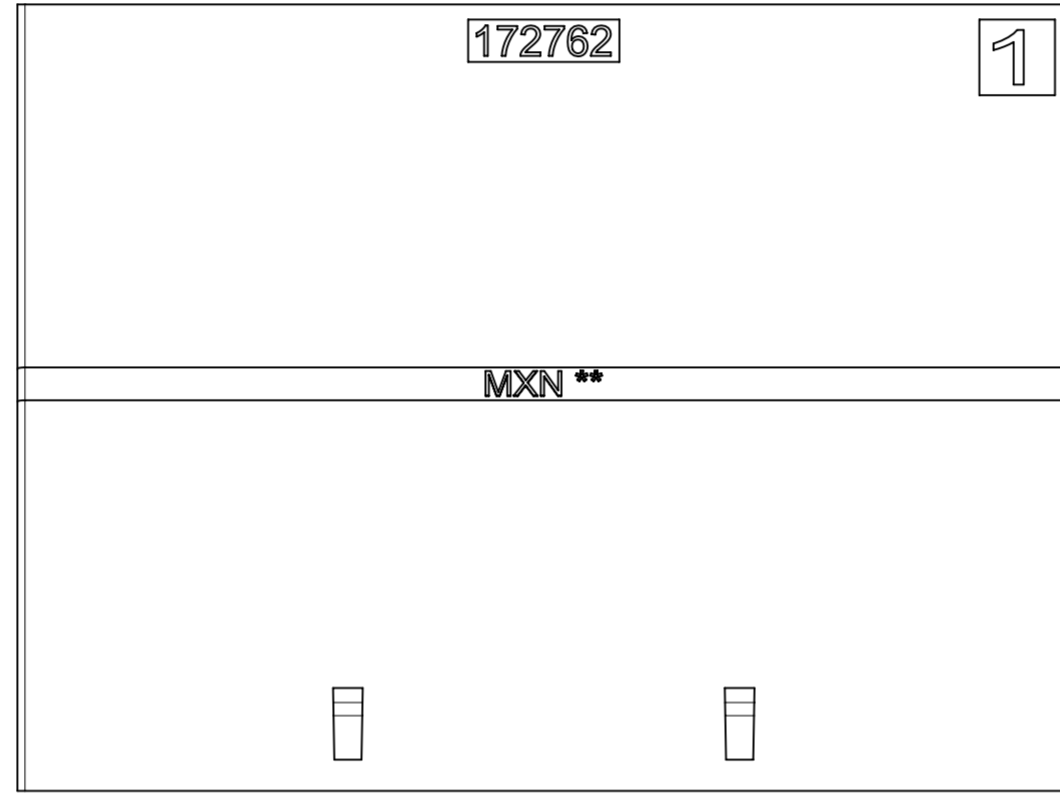
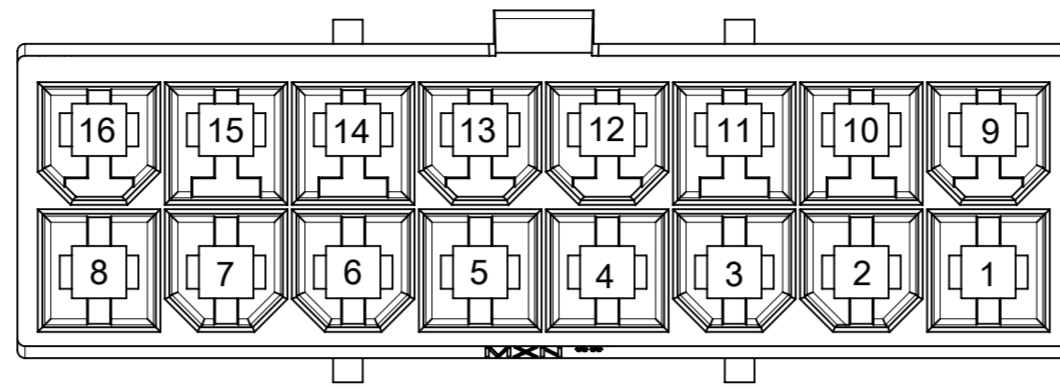

16-CKT

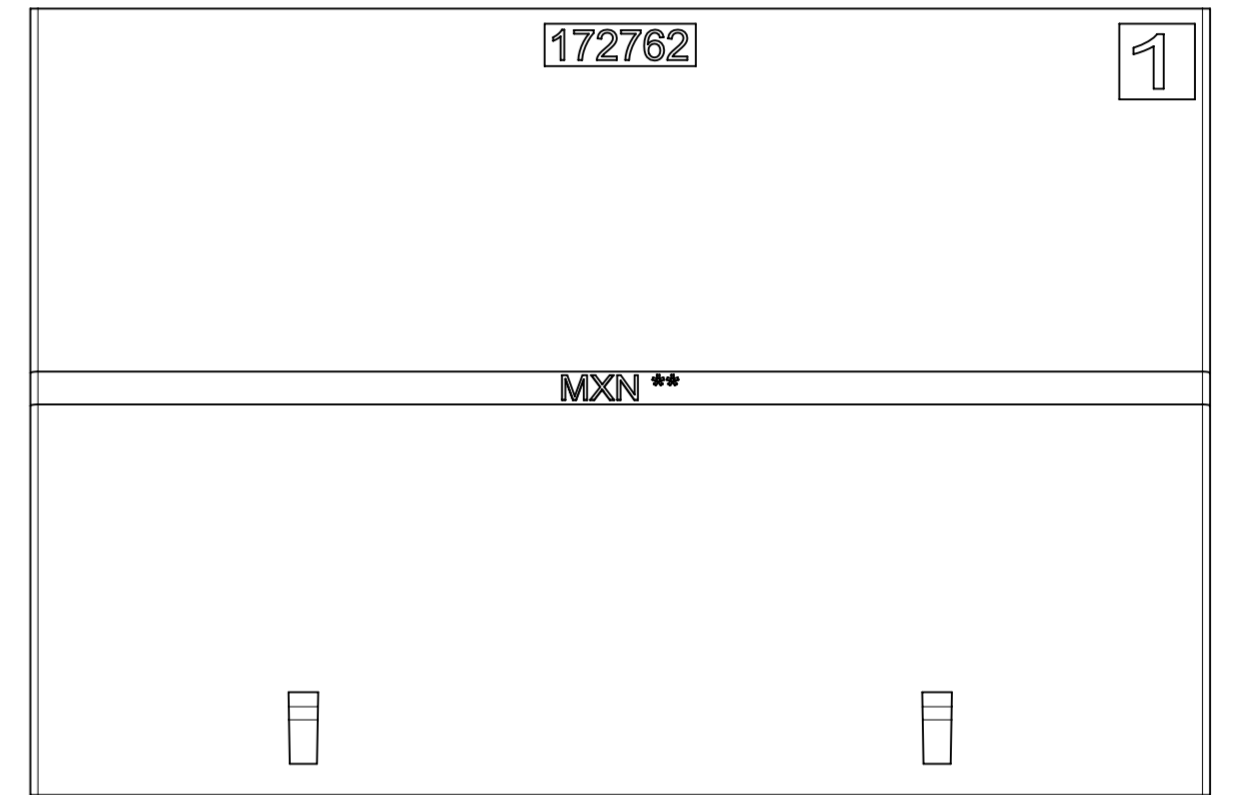
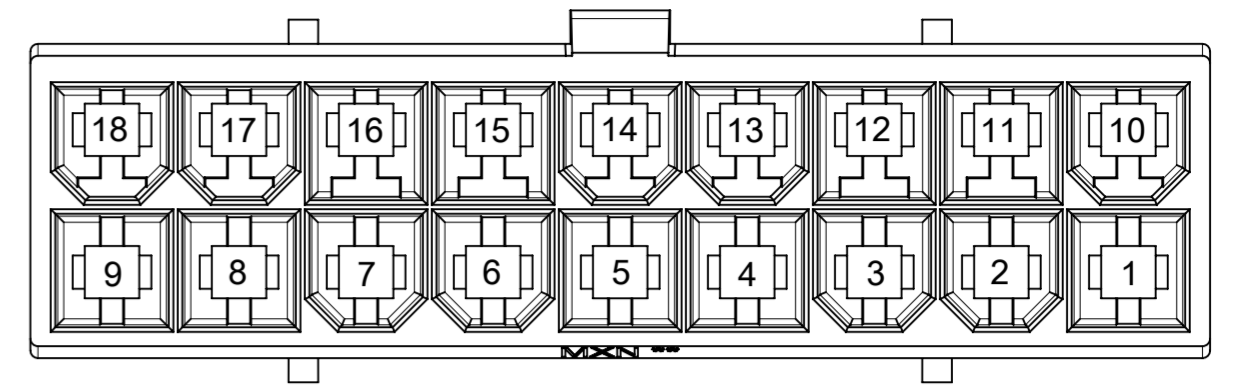

18-CKT

THIS DRAWING CONTAINS INFORMATION THAT IS PROPRIETARY TO MOLEX ELECTRONIC TECHNOLOGIES, LLC AND SHOULD NOT BE USED WITHOUT WRITTEN PERMISSION											
DIMENSION UNITS	SCALE	CURRENT REV DESC:				molex					
mm	NTS										
GENERAL TOLERANCES (UNLESS SPECIFIED)						SD-DRAWING OF MINI-FIT SIGMA DR PLUG					
ANGULAR TOL	± °					PRODUCT CUSTOMER DRAWING					
4 PLACES	±	EC NO: 768511		2023/11/02		DOCUMENT NUMBER					
3 PLACES	±	DRWN: JERRYW8		2023/11/15							
2 PLACES	± 0.25	CHK'D: XQZHANG		2023/11/15		1727620001-SD					
1 PLACE	± 0.36	APPR: XQZHANG		2023/11/15							
0 PLACES	±	INITIAL REVISION:		2019/09/18		DOC TYPE DOC PART REVISION					
DRAFT WHERE APPLICABLE MUST REMAIN WITHIN DIMENSIONS		DRWN: ALU002		2019/10/11						PSD 000 A6	
		APPR: YXZHENG				MATERIAL NUMBER		CUSTOMER		SHEET NUMBER	
		THIRD ANGLE PROJECTION		DRAWING		SERIES		GENERAL MARKET		4 OF 4	